

STM32 microcontroller system memory boot mode

Introduction

The bootloader is stored in the internal boot ROM memory (system memory) of STM32 devices. It is programmed by ST during production. Its main task is to download the application program to the internal Flash memory through one of the available serial peripherals (USART, CAN, USB, I²C, SPI, etc.). A communication protocol is defined for each serial interface, with a compatible command set and sequences. This document applies to the products listed in [Table 1](#). They are referred as STM32 throughout the document.

Table 1. Applicable products

Type	Part number or product series
Microcontrollers	STM32L0 Series.
	STM32L1 Series: STM32L100xx, STM32L151xx, STM32L152xx, STM32L162xx
	STM32L4 series: STM32L431xx, STM32L432xx, STM32L433xx, STM32L442xx, STM32L443xx, STM32L476xx, STM32L486xx
	STM32F0 Series: STM32F03xxx, STM32F04xxx, STM32F05xxx, STM32F07xxx, STM32F09xxx
	STM32F1 Series.
	STM32F2 Series.
	STM32F3 Series: STM32F301xx, STM32F302xx, STM32F303xx, STM32F318xx, STM32F328xx, STM32F334xx, STM32F358xx, STM32F373xx, STM32F378xx, STM32F398xx
	STM32F4 Series: STM32F401xx, STM32F405xx, STM32F407xx, STM32F410xx, STM32F411xx, STM32F412xx, STM32F415xx, STM32F417xx, STM32F427xx, STM32F429xx, STM32F437xx, STM32F439xx, STM32F446xx, STM32F469xx, STM32F479xx
	STM32F7 Series: STM32F745xx, STM32F746xx, STM32F756xx, STM32F765xx, STM32F767xx, STM32F769xx, STM32F777xx, STM32F779xx

The main features of the bootloader are the following:

- It uses an embedded serial interface to download the code with a predefined communication protocol.
- It transfers and updates the Flash memory code, the data, and the vector table sections.

This application note presents the general concept of the bootloader. It describes the supported peripherals and hardware requirements to be considered when using the bootloader of STM32 devices. However the specifications of the low-level communication protocol for each supported serial peripheral are documented in separate documents as referred in [Section 1: Related documents](#).

Contents

- 1 Related documents 15**
- 2 Glossary 15**
- 3 General bootloader description 19**
 - 3.1 Bootloader activation 19
 - 3.2 Bootloader identification 21
 - 3.3 Hardware connection requirements 26
 - 3.4 Bootloader Memory Management 28
- 4 STM32F03xx4/6 devices bootloader 30**
 - 4.1 Bootloader configuration 30
 - 4.2 Bootloader selection 31
 - 4.3 Bootloader version 31
- 5 STM32F030xC devices bootloader 32**
 - 5.1 Bootloader configuration 32
 - 5.2 Bootloader selection 33
 - 5.3 Bootloader version 33
- 6 STM32F05xxx and STM32F030x8 devices bootloader 34**
 - 6.1 Bootloader configuration 34
 - 6.2 Bootloader selection 35
 - 6.3 Bootloader version 35
- 7 STM32F04xxx devices bootloader 36**
 - 7.1 Bootloader configuration 36
 - 7.2 Bootloader selection 38
 - 7.3 Bootloader version 38
- 8 STM32F070x6 devices bootloader 39**
 - 8.1 Bootloader configuration 39
 - 8.2 Bootloader selection 41

8.3	Bootloader version	42
9	STM32F070xB devices bootloader	43
9.1	Bootloader configuration	43
9.2	Bootloader selection	45
9.3	Bootloader version	46
10	STM32F071xx/72xx devices bootloader	47
10.1	Bootloader configuration	47
10.2	Bootloader selection	49
10.3	Bootloader version	49
11	STM32F09xxx devices bootloader	50
11.1	Bootloader configuration	50
11.2	Bootloader selection	51
11.3	Bootloader version	51
12	STM32F10xxx devices bootloader	52
12.1	Bootloader configuration	52
12.2	Bootloader selection	53
12.3	Bootloader version	53
13	STM32F105xx/107xx devices bootloader	54
13.1	Bootloader configuration	54
13.2	Bootloader selection	56
13.3	Bootloader version	57
13.3.1	How to identify STM32F105xx/107xx bootloader versions	57
13.3.2	Bootloader unavailability on STM32F105xx/STM32F107xx devices with a date code below 937	58
13.3.3	USART bootloader Get-Version command returns 0x20 instead of 0x22	59
13.3.4	PA9 excessive power consumption when USB cable is plugged in bootloader V2.0	59
14	STM32F10xxx XL-density devices bootloader	60
14.1	Bootloader configuration	60
14.2	Bootloader selection	61

14.3	Bootloader version	61
15	STM32F2xxxx devices bootloader	62
15.1	Bootloader V2.x	62
15.1.1	Bootloader configuration	62
15.1.2	Bootloader selection	63
15.1.3	Bootloader version	64
15.2	Bootloader V3.x	65
15.2.1	Bootloader configuration	65
15.2.2	Bootloader selection	67
15.2.3	Bootloader version	68
16	STM32F301xx/302x4(6/8) devices bootloader	69
16.1	Bootloader configuration	69
16.2	Bootloader selection	71
16.3	Bootloader version	71
17	STM32F302xB(C)/303xB(C) devices bootloader	72
17.1	Bootloader configuration	72
17.2	Bootloader selection	74
17.3	Bootloader version	74
18	STM32F302xD(E)/303xD(E) devices bootloader	75
18.1	Bootloader configuration	75
18.2	Bootloader selection	77
18.3	Bootloader version	78
19	STM32F303x4(6/8)/334xx/328xx devices bootloader	79
19.1	Bootloader configuration	79
19.2	Bootloader selection	80
19.3	Bootloader version	80
20	STM32F318xx devices bootloader	81
20.1	Bootloader configuration	81
20.2	Bootloader selection	82
20.3	Bootloader version	83

21	STM32F358xx devices bootloader	84
	21.1 Bootloader configuration	84
	21.2 Bootloader selection	85
	21.3 Bootloader version	85
22	STM32F373xx devices bootloader	86
	22.1 Bootloader configuration	86
	22.2 Bootloader selection	88
	22.3 Bootloader version	88
23	STM32F378xx devices bootloader	89
	23.1 Bootloader configuration	89
	23.2 Bootloader selection	90
	23.3 Bootloader version	90
24	STM32F398xx devices bootloader	91
	24.1 Bootloader configuration	91
	24.2 Bootloader selection	92
	24.3 Bootloader version	92
25	STM32F40xxx/41xxx devices bootloader	93
	25.1 Bootloader V3.x	93
	25.1.1 Bootloader configuration	93
	25.1.2 Bootloader selection	95
	25.1.3 Bootloader version	96
	25.2 Bootloader V9.x	97
	25.2.1 Bootloader configuration	97
	25.2.2 Bootloader selection	101
	25.2.3 Bootloader version	102
26	STM32F401xB(C) devices bootloader	103
	26.1 Bootloader configuration	103
	26.2 Bootloader selection	107
	26.3 Bootloader version	108
27	STM32F401xD(E) devices bootloader	109

27.1	Bootloader configuration	109
27.2	Bootloader selection	112
27.3	Bootloader version	113
28	STM32F410xx device bootloader	114
28.1	Bootloader configuration	114
28.2	Bootloader selection	117
28.3	Bootloader version	118
29	STM32F411xx devices bootloader	119
29.1	Bootloader configuration	119
29.2	Bootloader selection	123
29.3	Bootloader version	124
30	STM32F412xx devices bootloader	125
30.1	Bootloader configuration	125
30.2	Bootloader selection	129
30.3	Bootloader version	130
31	STM32F42xxx/43xxx devices bootloader	131
31.1	Bootloader V7.x	131
31.1.1	Bootloader configuration	131
31.1.2	Bootloader selection	133
31.1.3	Bootloader version	135
31.2	Bootloader V9.x	136
31.2.1	Bootloader configuration	136
31.2.2	Bootloader selection	140
31.2.3	Bootloader version	142
32	STM32F446xx devices bootloader	143
32.1	Bootloader configuration	143
32.2	Bootloader selection	147
32.3	Bootloader version	148
33	STM32F469xx/479xx devices bootloader	149
33.1	Bootloader configuration	149

33.2	Bootloader selection	153
33.3	Bootloader version	155
34	STM32F74xxx/75xxx devices bootloader	156
34.1	Bootloader V7.x	156
34.1.1	Bootloader configuration	156
34.1.2	Bootloader selection	159
34.1.3	Bootloader version	160
34.2	Bootloader V9.x	161
34.2.1	Bootloader configuration	161
34.2.2	Bootloader selection	165
34.2.3	Bootloader version	166
35	STM32F76xxx/77xxx devices bootloader	167
35.1	Bootloader configuration	167
35.2	Bootloader selection	170
35.3	Bootloader version	173
36	STM32L01xxx/02xxx devices bootloader	174
36.1	Bootloader configuration	174
36.2	Bootloader selection	176
36.3	Bootloader version	177
37	STM32L031xx/041xx devices bootloader	178
37.1	Bootloader configuration	178
37.2	Bootloader selection	180
37.3	Bootloader version	180
38	STM32L05xxx/06xxx devices bootloader	181
38.1	Bootloader configuration	181
38.2	Bootloader selection	183
38.3	Bootloader version	183
39	STM32L07xxx/08xxx devices bootloader	184
39.1	Bootloader V4.x	184
39.1.1	Bootloader configuration	184

	39.1.2	Bootloader selection	186
	39.1.3	Bootloader version	187
39.2		Bootloader V11.x	188
	39.2.1	Bootloader configuration	188
	39.2.2	Bootloader selection	190
	39.2.3	Bootloader version	192
40		STM32L1xxx6(8/B)A devices bootloader	193
	40.1	Bootloader configuration	193
	40.2	Bootloader selection	194
	40.3	Bootloader version	194
41		STM32L1xxx6(8/B) devices bootloader	195
	41.1	Bootloader configuration	195
	41.2	Bootloader selection	196
	41.3	Bootloader version	196
42		STM32L1xxxC devices bootloader	197
	42.1	Bootloader configuration	197
	42.2	Bootloader selection	199
	42.3	Bootloader version	199
43		STM32L1xxxD devices bootloader	200
	43.1	Bootloader configuration	200
	43.2	Bootloader selection	202
	43.3	Bootloader version	203
44		STM32L1xxxE devices bootloader	204
	44.1	Bootloader configuration	204
	44.2	Bootloader selection	206
	44.3	Bootloader version	207
45		STM32L43xx/44xx devices bootloader	208
	45.1	Bootloader configuration	208
	45.2	Bootloader selection	211

45.3	Bootloader version	212
46	STM32L476xx/486xx devices bootloader	213
46.1	Bootloader V10.x	213
46.1.1	Bootloader configuration	213
46.1.2	Bootloader selection	216
46.1.3	Bootloader version	218
46.2	Bootloader V9.x	219
46.2.1	Bootloader configuration	219
46.2.2	Bootloader selection	222
46.2.3	Bootloader version	224
47	Device-dependent bootloader parameters	225
48	Bootloader timing	228
48.1	Bootloader Startup timing	228
48.2	USART connection timing	231
48.3	USB connection timing	233
48.4	I2C connection timing	235
48.5	SPI connection timing	237
49	Revision history	238

List of tables

Table 1.	Applicable products	1
Table 2.	Bootloader activation patterns	19
Table 3.	Embedded bootloaders	21
Table 4.	STM32 F2, F4 and F7 Voltage Range configuration using bootloader	29
Table 5.	Supported memory area by Write, Read, Erase and Go Commands	29
Table 6.	STM32F03xx4/6 configuration in system memory boot mode	30
Table 7.	STM32F03xx4/6 bootloader versions	31
Table 8.	STM32F030xC configuration in system memory boot mode	32
Table 9.	STM32F030xC bootloader versions	33
Table 10.	STM32F05xxx and STM32F030x8 devices configuration in system memory boot mode	34
Table 11.	STM32F05xxx and STM32F030x8 devices bootloader versions	35
Table 12.	STM32F04xxx configuration in system memory boot mode	36
Table 13.	STM32F04xxx bootloader versions	38
Table 14.	STM32F070x6 configuration in system memory boot mode	39
Table 15.	STM32F070x6 bootloader versions	42
Table 16.	STM32F070xB configuration in system memory boot mode	43
Table 17.	STM32F070xB bootloader versions	46
Table 18.	STM32F071xx/72xx configuration in system memory boot mode	47
Table 19.	STM32F071xx/72xx bootloader versions	49
Table 20.	STM32F09xxx configuration in system memory boot mode	50
Table 21.	STM32F09xxx bootloader versions	51
Table 22.	STM32F10xxx configuration in system memory boot mode	52
Table 23.	STM32F10xxx bootloader versions	53
Table 24.	STM32F105xx/107xx configuration in system memory boot mode	54
Table 25.	STM32F105xx/107xx bootloader versions	57
Table 26.	STM32F10xxx XL-density configuration in system memory boot mode	60
Table 27.	STM32F10xxx XL-density bootloader versions	61
Table 28.	STM32F2xxxx configuration in system memory boot mode	62
Table 29.	STM32F2xxxx bootloader V2.x versions	64
Table 30.	STM32F2xxxx configuration in system memory boot mode	65
Table 31.	STM32F2xxxx bootloader V3.x versions	68
Table 32.	STM32F301xx/302x4(6/8) configuration in system memory boot mode	69
Table 33.	STM32F301xx/302x4(6/8) bootloader versions	71
Table 34.	STM32F302xB(C)/303xB(C) configuration in system memory boot mode	72
Table 35.	STM32F302xB(C)/303xB(C) bootloader versions	74
Table 36.	STM32F302xD(E)/303xD(E) configuration in system memory boot mode	75
Table 37.	STM32F302xD(E)/303xD(E) bootloader versions	78
Table 38.	STM32F303x4(6/8)/334xx/328xx configuration in system memory boot mode	79
Table 39.	STM32F303x4(6/8)/334xx/328xx bootloader versions	80
Table 40.	STM32F318xx configuration in system memory boot mode	81
Table 41.	STM32F318xx bootloader versions	83
Table 42.	STM32F358xx configuration in system memory boot mode	84
Table 43.	STM32F358xx bootloader versions	85
Table 44.	STM32F373xx configuration in system memory boot mode	86
Table 45.	STM32F373xx bootloader versions	88
Table 46.	STM32F378xx configuration in system memory boot mode	89
Table 47.	STM32F378xx bootloader versions	90
Table 48.	STM32F398xx configuration in system memory boot mode	91

Table 49.	STM32F398xx bootloader versions	92
Table 50.	STM32F40xxx/41xxx configuration in system memory boot mode.	93
Table 51.	STM32F40xxx/41xxx bootloader V3.x versions	96
Table 52.	STM32F40xxx/41xxx configuration in system memory boot mode.	97
Table 53.	STM32F40xxx/41xxx bootloader V9.x versions	102
Table 54.	STM32F401xB(C) configuration in system memory boot mode	103
Table 55.	STM32F401xB(C) bootloader versions	108
Table 56.	STM32F401xD(E) configuration in system memory boot mode	109
Table 57.	STM32F401xD(E) bootloader versions	113
Table 58.	STM32F410xx configuration in system memory boot mode.	114
Table 59.	STM32F410xx bootloader V11.x versions	118
Table 60.	STM32F411xx configuration in system memory boot mode.	119
Table 61.	STM32F411xx bootloader versions	124
Table 62.	STM32F412xx configuration in system memory boot mode.	125
Table 63.	STM32F412xx bootloader V9.x versions	130
Table 64.	STM32F42xxx/43xxx configuration in system memory boot mode.	131
Table 65.	STM32F42xxx/43xxx bootloader V7.x versions	135
Table 66.	STM32F42xxx/43xxx configuration in system memory boot mode.	136
Table 67.	STM32F42xxx/43xxx bootloader V9.x versions	142
Table 68.	STM32F446xx configuration in system memory boot mode.	143
Table 69.	STM32F446xx bootloader V9.x versions	148
Table 70.	STM32F469xx/479xx configuration in system memory boot mode	149
Table 71.	STM32F469xx/479xx bootloader V9.x versions	155
Table 72.	STM32F74xxx/75xxx configuration in system memory boot mode.	157
Table 73.	STM32F74xxx/75xxx bootloader V7.x versions	160
Table 74.	STM32F74xxx/75xxx configuration in system memory boot mode.	161
Table 75.	STM32F74xxx/75xxx bootloader V9.x versions	166
Table 76.	STM32F76xxx/77xxx configuration in system memory boot mode.	167
Table 77.	STM32F76xxx/77xxx bootloader V9.x versions	173
Table 78.	STM32L01xxx/02xxx configuration in system memory boot mode.	174
Table 79.	STM32L01xxx/02xxx bootloader versions	177
Table 80.	STM32L031xx/041xx configuration in system memory boot mode	178
Table 81.	STM32L031xx/041xx bootloader versions	180
Table 82.	STM32L05xxx/06xxx configuration in system memory boot mode.	181
Table 83.	STM32L05xxx/06xxx bootloader versions	183
Table 84.	STM32L07xxx/08xxx configuration in system memory boot mode.	184
Table 85.	STM32L07xxx/08xxx bootloader versions	187
Table 86.	STM32L07xxx/08xxx configuration in system memory boot mode.	188
Table 87.	STM32L07xxx/08xxx bootloader V11.x versions	192
Table 88.	STM32L1xxx6(8/B)A configuration in system memory boot mode.	193
Table 89.	STM32L1xxx6(8/B)A bootloader versions	194
Table 90.	STM32L1xxx6(8/B) configuration in system memory boot mode	195
Table 91.	STM32L1xxx6(8/B) bootloader versions.	196
Table 92.	STM32L1xxxC configuration in system memory boot mode.	197
Table 93.	STM32L1xxxC bootloader versions	199
Table 94.	STM32L1xxxD configuration in system memory boot mode.	200
Table 95.	STM32L1xxxD bootloader versions	203
Table 96.	STM32L1xxxE configuration in system memory boot mode.	204
Table 97.	STM32L1xxxE bootloader versions	207
Table 98.	STM32L43xx/44xx configuration in System memory boot mode	208
Table 99.	STM32L43xx/44xx bootloader versions	212
Table 100.	STM32L476xx/486xx configuration in system memory boot mode	213

Table 101.	STM32L476xx/486xx bootloader V10.x versions	218
Table 102.	STM32L476xx/486xx configuration in system memory boot mode	219
Table 103.	STM32L476xx/486xx bootloader V9.x versions	224
Table 104.	Bootloader device-dependent parameters	225
Table 105.	Bootloader startup timings of STM32 devices	228
Table 106.	USART bootloader minimum timings of STM32 devices	231
Table 107.	USB bootloader minimum timings of STM32 devices	234
Table 108.	I2C bootloader minimum timings of STM32 devices	235
Table 109.	SPI bootloader minimum timings of STM32 devices	237
Table 110.	Document revision history	238

List of figures

Figure 1.	USART Connection	26
Figure 2.	USB Connection	26
Figure 3.	I2C Connection	27
Figure 4.	SPI Connection	27
Figure 5.	CAN Connection	28
Figure 6.	Bootloader selection for STM32F03xx4/6 devices	31
Figure 7.	Bootloader selection for STM32F030xC	33
Figure 8.	Bootloader selection for STM32F05xxx and STM32F030x8 devices	35
Figure 9.	Bootloader selection for STM32F04xxx	38
Figure 10.	Bootloader selection for STM32F070x6	41
Figure 11.	Bootloader selection for STM32F070xB	45
Figure 12.	Bootloader selection for STM32F071xx/72xx	49
Figure 13.	Bootloader selection for STM32F09xxx	51
Figure 14.	Bootloader selection for STM32F10xxx	53
Figure 15.	Bootloader selection for STM32F105xx/107xx devices	56
Figure 16.	Bootloader selection for STM32F10xxx XL-density devices	61
Figure 17.	Bootloader V2.x selection for STM32F2xxxx devices	63
Figure 18.	Bootloader V3.x selection for STM32F2xxxx devices	67
Figure 19.	Bootloader selection for STM32F301xx/302x4(6/8)	71
Figure 20.	Bootloader selection for STM32F302xB(C)/303xB(C) devices	74
Figure 21.	Bootloader selection for STM32F302xD(E)/303xD(E)	77
Figure 22.	Bootloader selection for STM32F303x4(6/8)/334xx/328xx	80
Figure 23.	Bootloader selection for STM32F318xx	82
Figure 24.	Bootloader selection for STM32F358xx devices	85
Figure 25.	Bootloader selection for STM32F373xx devices	88
Figure 26.	Bootloader selection for STM32F378xx devices	90
Figure 27.	Bootloader selection for STM32F398xx	92
Figure 28.	Bootloader V3.x selection for STM32F40xxx/41xxx devices	95
Figure 29.	Bootloader V9.x selection for STM32F40xxx/41xxx	101
Figure 30.	Bootloader selection for STM32F401xB(C)	107
Figure 31.	Bootloader selection for STM32F401xD(E)	112
Figure 32.	Bootloader V11.x selection for STM32F410xx	117
Figure 33.	Bootloader selection for STM32F411xx	123
Figure 34.	Bootloader V9.x selection for STM32F412xx	129
Figure 35.	Dual Bank Boot Implementation for STM32F42xxx/43xxx Bootloader V7.x	133
Figure 36.	Bootloader V7.x selection for STM32F42xxx/43xxx	134
Figure 37.	Dual Bank Boot Implementation for STM32F42xxx/43xxx Bootloader V9.x	140
Figure 38.	Bootloader V9.x selection for STM32F42xxx/43xxx	141
Figure 39.	Bootloader V9.x selection for STM32F446xx	147
Figure 40.	Dual Bank Boot Implementation for STM32F469xx/479xx Bootloader V9.x	153
Figure 41.	Bootloader V9.x selection for STM32F469xx/479xx	154
Figure 42.	Bootloader V7.x selection for STM32F74xxx/75xxx	159
Figure 43.	Bootloader V9.x selection for STM32F74xxx/75xxx	165
Figure 44.	Dual Bank Boot Implementation for STM32F76xxx/77xxx Bootloader V9.x	171
Figure 45.	Bootloader V9.x selection for STM32F76xxx/77xxx	172
Figure 46.	Bootloader selection for STM32L01xxx/02xxx	176
Figure 47.	Bootloader selection for STM32L031xx/041xx	180
Figure 48.	Bootloader selection for STM32L05xxx/06xxx	183

Figure 49.	Dual Bank Boot Implementation for STM32L07xxx/08xxx Bootloader V4.x	186
Figure 50.	Bootloader V4.x selection for STM32L07xxx/08xxx	187
Figure 51.	Dual Bank Boot Implementation for STM32L07xxx/08xxx Bootloader V11.x	190
Figure 52.	Bootloader V11.x selection for STM32L07xxx/08xxx	191
Figure 53.	Bootloader selection for STM32L1xxx6(8/B)A devices	194
Figure 54.	Bootloader selection for STM32L1xxx6(8/B) devices	196
Figure 55.	Bootloader selection for STM32L1xxxC devices	199
Figure 56.	Bootloader selection for STM32L1xxxD devices	202
Figure 57.	Bootloader selection for STM32L1xxxE devices	206
Figure 58.	Bootloader V9.x selection for STM32L43xx/44xx	211
Figure 59.	Dual Bank Boot Implementation for STM32L476xx/486xx Bootloader V10.x	216
Figure 60.	Bootloader V10.x selection for STM32L476xx/486xx	217
Figure 61.	Dual Bank Boot Implementation for STM32L476xx/486xx Bootloader V9.x	222
Figure 62.	Bootloader V9.x selection for STM32L476xx/486xx	223
Figure 63.	Bootloader Startup timing description	228
Figure 64.	USART connection timing description	231
Figure 65.	USB connection timing description	233
Figure 66.	I2C connection timing description	235
Figure 67.	SPI connection timing description	237

1 Related documents

For each supported product (listed in [Table 1](#)), please refer to the following documents available from www.st.com:

- Datasheet or databrief
- Reference manual
- Application Note:
 - AN3154: CAN protocol used in the STM32 bootloader
 - AN3155: USART protocol used in the STM32 bootloader
 - AN3156: USB DFU protocol used in the STM32 bootloader
 - AN4221: I2C protocol used in the STM32 bootloader
 - AN4286: SPI protocol used in the STM32 bootloader

2 Glossary

F0 Series:

STM32F03xxx is used to refer to STM32F030x4, STM32F030x6, STM32F038x6, STM32F030xC, STM32F031x4 and STM32F031x6 devices.

STM32F04xxx is used to refer to STM32F042x4 and STM32F042x6 devices.

STM32F05xxx and STM32F030x8 devices is used to refer to STM32F051x4, STM32F051x6, STM32F051x8, STM32F058x8 and STM32F030x8 devices.

STM32F07xxx is used to refer to STM32F070x6, STM32F070xB, STM32F071xB, STM32F072x8 and STM32F072xB devices.

STM32F09xxx is used to refer to STM32F091xx and STM32F098xx devices.

F1 Series:

STM32F10xxx is used to refer to Low-density, Medium-density, High-density, Low-density value line, Medium-density value line and High-density value line devices:

Low-density devices are STM32F101xx, STM32F102xx and STM32F103xx microcontrollers where the Flash memory density ranges between 16 and 32 Kbytes.

Medium-density devices are STM32F101xx, STM32F102xx and STM32F103xx microcontrollers where the Flash memory density ranges between 64 and 128 Kbytes.

High-density devices are STM32F101xx and STM32F103xx microcontrollers where the Flash memory density ranges between 256 and 512 Kbytes.

Low-density value line devices are STM32F100xx microcontrollers where the Flash memory density ranges between 16 and 32 Kbytes.

Medium-density value line devices are STM32F100xx microcontrollers where the Flash memory density ranges between 64 and 128 Kbytes.

High-density value line devices are STM32F100xx microcontrollers where the Flash memory density ranges between 256 and 512 Kbytes.

STM32F105xx/107xx is used to refer to STM32F105xx and STM32F107xx devices.

STM32F10xxx XL-density is used to refer to STM32F101xx and STM32F103xx devices where the Flash memory density ranges between 768 Kbytes and 1 Mbyte.

F2 Series:

STM32F2xxxx is used to refer to STM32F215xx, STM32F205xx, STM32F207xx and STM32F217xx devices.

F3 Series:

STM32F301xx/302x4(6/8) is used to refer to STM32F301x4, STM32F301x6, STM32F301x8, STM32F302x4, STM32F302x6 and STM32F302x8 devices.

STM32F302xB(C)/303xB(C) is used to refer to STM32F302xB, STM32F302xC, STM32F303xB and STM32F303xC devices.

STM32F302xD(E)/303xD(E) is used to refer to STM32F302xD, STM32F302xE, STM32F303xD and STM32F303xE devices.

STM32F303x4(6/8)/334xx/328xx is used to refer to STM32F303x4, STM32F303x6, STM32F303x8, STM32F334x4, STM32F334x6, STM32F334x8, and STM32F328x8 devices.

STM32F318xx is used to refer to STM32F318x8 devices.

STM32F358xx is used to refer to STM32F358xC devices.

STM32F373xx is used to refer to STM32F373x8, STM32F373xB and STM32F373xC devices.

STM32F378xx is used to refer to STM32F378xC devices.

STM32F398xx is used to refer to STM32F398xE devices.

F4 Series:

STM32F40xxx/41xxx is used to refer to STM32F405xx, STM32F407xx, STM32F415xx and SMT32F417xx devices.

STM32F401xB(C) is used to refer to STM32F401xB and STM32F401xC devices.

STM32F401xD(E) is used to refer to STM32F401xD and STM32F401xE devices.

STM32F410xx is used to refer to STM32F410x8 and STM32F410xB devices.

STM32F411xx is used to refer to STM32F411xD and STM32F411xE devices.

STM32F412xx is used to refer to STM32F412Cx, STM32F412Rx, STM32F412Vx and STM32F412Zx devices.

STM32F42xxx/43xxx is used to refer to STM32F427xx, STM32F429xx, STM32F437xx and STM32F439xx devices

STM32F446xx is used to refer to STM32F446xE and STM32F446xC devices

STM32F469xx/479xx is used to refer to STM32F469xE, STM32F469xG, STM32F469xI, STM32F479xG and STM32F479xI devices.

F7 Series:

STM32F74xxx/75xxx is used to refer to STM32F745xx, STM32F746xx and STM32F756xx devices.

STM32F76xxx/77xxx is used to refer to STM32F765xx, STM32F767xx, STM32F769xx, STM32F777xx and STM32F779xx devices.

L0 Series:

STM32L01xxx/02xxx is used to refer to STM32L011xx and STM32L021xx devices.

STM32L031xx/041xx is used to refer to STM32L031xx and STM32L041xx devices.

STM32L05xxx/06xxx is used to refer to STM32L051xx, STM32L052xx, STM32L053xx, STM32L062xx and STM32L063xx ultralow power devices.

STM32L07xxx/08xxx is used to refer to STM32L071xx, STM32L072xx, STM32L073xx, STM32L081xx, STM32L082xx and STM32L083xx devices

L1 Series:

STM32L1xxx6(8/B) is used to refer to STM32L1xxV6T6, STM32L1xxV6H6, STM32L1xxR6T6, STM32L1xxR6H6, STM32L1xxC6T6, STM32L1xxC6H6, STM32L1xxV8T6, STM32L1xxV8H6, STM32L1xxR8T6, STM32L1xxR8H6, STM32L1xxC8T6, STM32L1xxC8H6, STM32L1xxVBT6, STM32L1xxVBH6, STM32L1xxRBT6, STM32L1xxRBH6, STM32L1xxCBT6 and STM32L1xxCBH6 ultralow power devices.

STM32L1xxx6(8/B)A is used to refer to STM32L1xxV6T6-A, STM32L1xxV6H6-A, STM32L1xxR6T6-A, STM32L1xxR6H6-A, STM32L1xxC6T6-A, STM32L1xxC6H6-A, STM32L1xxV8T6-A, STM32L1xxV8H6-A, STM32L1xxR8T6-A, STM32L1xxR8H6-A, STM32L1xxC8T6-A, STM32L1xxC8H6-A, STM32L1xxVBT6-A, STM32L1xxVBH6-A, STM32L1xxRBT6-A, STM32L1xxRBH6-A, STM32L1xxCBT6-A and STM32L1xxCBH6-A ultralow power devices.

STM32L1xxxC is used to refer to STM32L1xxVCT6, STM32L1xxVCH6, STM32L1xxRCT6, STM32L1xxUCY6, STM32L1xxCCT6 and STM32L1xxCCU6 ultralow power devices.

STM32L1xxxD is used to refer to STM32L1xxZDT6, STM32L1xxQDH6, STM32L1xxVDT6, STM32L1xxRDY6, STM32L1xxRDT6, STM32L1xxZCT6,

STM32L1xxQCH6, STM32L1xxRCY6, STM32L1xxVCT6-A and STM32L1xxRCT6-A ultralow power devices.

STM32L1xxxE is used to refer to STM32L1xxZET6, STM32L1xxQEH6, STM32L1xxVET6, STM32L1xxVEY6, and STM32L1xxRET6 ultralow power devices.

L4 Series:

STM32L43xxx/44xxx is used to refer to STM32L431xx, STM32L432xx, STM32L433xx and STM32L44xxx devices.

STM32L476xx/486xx is used to refer to STM32L476xE, STM32L476xG and STM32L486xG devices

Note: *BL_USART_Loop* refers to the *USART Bootloader execution loop*.
BL_CAN_Loop refers to the *CAN Bootloader execution loop*.
BL_I2C_Loop refers to the *I2C Bootloader execution loop*.
BL_SPI_Loop refers to the *SPI Bootloader execution loop*.

3 General bootloader description

3.1 Bootloader activation

The bootloader is activated by applying one of the patterns described in [Table 2: Bootloader activation patterns](#).

If Boot From Bank2 option is activated (for products supporting this feature), Bootloader executes Dual Boot mechanism as described in figures "Dual Bank Boot Implementation for STM32xxxx" where STM32xxxx is the relative STM32 product.

Otherwise, Bootloader selection protocol is executed as described in figures "Bootloader VY.x selection for STM32xxxx" where STM32xxxx is the relative STM32 product.

When readout protection Level2 is activated, STM32 does not boot on system memory in any case and Bootloader can't be executed (unless jumping to it from Flash user code, all commands are not accessible except Get, GetID, and GetVersion).

Table 2. Bootloader activation patterns

Patterns	Condition
Pattern1	Boot0(pin) = 1 and Boot1(pin) = 0
Pattern2	Boot0(pin) = 1 and nBoot1(bit) = 1
Pattern3	Boot0(pin) = 1, Boot1(pin) = 0 and BFB2(bit) = 1
	Boot0(pin) = 0, BFB2(bit) = 0 and both banks don't contain valid code
	Boot0(pin) = 1, Boot1(pin) = 0, BFB2(bit) = 0 and both banks don't contain valid code
Pattern4	Boot0(pin) = 1, Boot1(pin) = 0 and BFB2(bit) = 1
	Boot0(pin) = 0, BFB2(bit) = 0 and both banks don't contain valid code
	Boot0(pin) = 1, Boot1(pin) = 0 and BFB2(bit) = 0
Pattern5	Boot0(pin) = 1, Boot1(pin) = 0 and BFB2(bit) = 0
	Boot0(pin) = 0, BFB2(bit) = 1 and both banks don't contain valid code
	Boot0(pin) = 1, Boot1(pin) = 0 and BFB2 (bit) = 1
Pattern6	Boot0(pin) = 1, nBoot1(bit) = 1 and nBoot0_SW(bit) = 1
	nBoot0(bit) = 0, nBoot1(bit) = 1 and nBoot0_SW(bit) = 0
	Boot0(pin) = 0, nBoot0_SW (bit) = 1 and main flash empty
Pattern7	Boot0(pin) = 1, nBoot1(bit) = 1 and BFB2(bit) = 0
	Boot0(pin) = 0, BFB2(bit) = 1 and both banks don't contain valid code
	Boot0(pin) = 1, nBoot1(bit) = 1 and BFB2(bit) = 1
Pattern8	Boot(pin) = 0 and BOOT_ADD0(optionbyte) = 0x0040
	Boot(pin) = 1 and BOOT_ADD1(optionbyte) = 0x0040

Table 2. Bootloader activation patterns (continued)

Patterns	Condition
Pattern9	nDBANK(bit) = 1, Boot(pin) = 0 and BOOT_ADD0(optionbyte) = 0x0040
	nDBANK(bit) = 1, Boot(pin) = 1 and BOOT_ADD1(optionbyte) = 0x0040
	nDBANK(bit) = 0, nDBOOT(bit) = 1, Boot(pin) = 0 and BOOT_ADD0(optionbyte) = 0x0040
	nDBANK(bit) = 0, nDBOOT(bit) = 1, Boot(pin) = 1 and BOOT_ADD1(optionbyte) = 0x0040
	nDBANK(bit) = 0, nDBOOT(bit) = 0, BOOT_ADDx(optionbyte) out of memory range or in ICP memory range
	nDBANK(bit) = 0, nDBOOT(bit) = 0, BOOT_ADDx(optionbyte) in Flash memory range and both banks don't contain valid code

In addition to patterns described above, user can execute bootloader by performing a jump to system memory from user code. Before jumping to Bootloader user must:

- Disable all peripheral clocks
- Disable used PLL
- Disable interrupts
- Clear pending interrupts

System memory boot mode can be exited by getting out from bootloader activation condition and generating hardware reset or using Go command to execute user code.

Note: If you choose to execute the Go command, the peripheral registers used by the bootloader are not initialized to their default reset values before jumping to the user application. They should be reconfigured in the user application if they are used. So, if the IWDG is being used in the application, the IWDG prescaler value has to be adapted to meet the requirements of the application (since the prescaler was set to its maximum value).

Note: For STM32 devices having the Dual Bank Boot feature, in order to jump to system memory from user code, the user has first to remap the System Memory Bootloader at address 0x00000000 using SYSCFG register, then jump to Bootloader. Refer to product Reference Manual for details about Memory remapping.

Note: For STM32 devices embedding bootloader using the DFU/CAN interface in which the external clock source (HSE) is required for DFU/CAN operations, the detection of the HSE value is done dynamically by the bootloader firmware and is based on the internal oscillator clock (HSI, MSI). Thus, when due to temperature or other conditions, the internal oscillator precision is altered above the tolerance band (1% around the theoretical value), the bootloader might calculate a wrong HSE frequency value. In this case, the bootloader DFU/CAN interfaces might dysfunction or might not work at all.

3.2 Bootloader identification

Depending on the STM32 device used, the bootloader may support one or more embedded serial peripherals used to download the code to the internal Flash memory. The bootloader identifier (ID) provides information about the supported serial peripherals.

For a given STM32 device, the bootloader is identified by means of the:

1. **Bootloader (protocol) version:** version of the serial peripheral (USART, CAN, USB, etc.) communication protocol used in the bootloader. This version can be retrieved using the bootloader Get Version command.
2. **Bootloader identifier (ID):** version of the STM32 device bootloader, coded on one byte in the **0xXY** format, where:
 - **X** specifies the embedded serial peripheral(s) used by the device bootloader:
 - X = 1: one USART is used
 - X = 2: two USARTs are used
 - X = 3: USART, CAN and DFU are used
 - X = 4: USART and DFU are used
 - X = 5: USART and I²C are used
 - X = 6: I²C is used
 - X = 7: USART, CAN, DFU and I²C are used
 - X = 8: I²C and SPI are used
 - X = 9: USART, CAN, DFU, I²C and SPI are used
 - X = 10: USART, DFU and I²C are used
 - X = 11: USART, I²C and SPI are used
 - X = 12: USART and SPI are used
 - X = 13: USART, DFU, I²C and SPI are used
 - **Y** specifies the device bootloader version
 Let us take the example of a bootloader ID equal to 0x10. This means that it is the first version of the device bootloader that uses only one USART.
 The bootloader ID is programmed in the last byte address - 1 of the device system memory and can be read by using the bootloader “Read memory” command or by direct access to the system memory via JTAG/SWD.

The table below provides identification information about the bootloaders embedded in STM32 devices.

Table 3. Embedded bootloaders

STM32 series	Device	Supported serial peripherals	Bootloader ID		Bootloader (protocol) version
			ID	Memory location	
F0	STM32F05xxx and STM32F030x8 devices	USART1/USART2	0x21	0x1FFFF7A6	USART (V3.1)
	STM32F03xx4/6	USART1	0x10	0x1FFFF7A6	USART (V3.1)
	STM32F030xC	USART1/I2C1	0x52	0x1FFFF796	USART (V3.1) I2C1(V1.0)
	STM32F04xxx	USART1/USART2/ I2C1/ DFU (USB Device FS)	0xA0	0x1FFFF6A6	USART (V3.1) DFU (V2.2) I2C (V1.0)
	STM32F071xx/72xx	USART1/USART2/ I2C1/ DFU (USB Device FS)	0xA1	0x1FFFF6A6	USART (V3.1) DFU (V2.2) I2C (V1.0)

Table 3. Embedded bootloaders (continued)

STM32 series	Device		Supported serial peripherals	Bootloader ID		Bootloader (protocol) version
				ID	Memory location	
F0	STM32F070x6		USART1/USART2/ DFU (USB Device FS)/I2C1	0xA2	0x1FFFF6A6	USART (V3.1) DFU (V2.2) I2C (V1.0)
	STM32F070xB		USART1/USART2/ DFU (USB Device FS)/I2C1	0xA2	0x1FFFF6A6	USART (V3.1) DFU (V2.2) I2C (V1.0)
	STM32F09xxx		USART1/USART2/ I2C1	0x50	0x1FFFF796	USART (V3.1) I2C (V1.0)
F1	STM32F10xxx	Low-density	USART1	NA	NA	USART (V2.2)
		Medium-density	USART1	NA	NA	USART (V2.2)
		High-density	USART1	NA	NA	USART (V2.2)
		Medium-density value line	USART1	0x10	0x1FFFF7D6	USART (V2.2)
		High-density value line	USART1	0x10	0x1FFFF7D6	USART (V2.2)
	STM32F105xx/107xx		USART1 / USART2 (remapped) / CAN2 (remapped) / DFU (USB Device)	NA	NA	USART (V2.2 ⁽¹⁾) CAN (V2.0) DFU(V2.2)
STM32F10xxx XL-density		USART1/USART2 (remapped)	0x21	0x1FFFF7D6	USART (V3.0)	
F2	STM32F2xxxx		USART1/USART3	0x20	0x1FFF77DE	USART (V3.0)
			USART1/USART3/ CAN2/ DFU (USB Device FS)	0x33	0x1FFF77DE	USART (V3.1) CAN (V2.0) DFU (V2.2)
F3	STM32F373xx		USART1/USART2/ DFU (USB Device FS)	0x41	0x1FFFF7A6	USART (V3.1) DFU (V2.2)
	STM32F378xx		USART1/USART2/ I2C1	0x50	0x1FFFF7A6	USART (V3.1) I2C (V1.0)
	STM32F302xB(C)/303xB(C)		USART1/USART2/ DFU (USB Device FS)	0x41	0x1FFFF796	USART (V3.1) DFU (V2.2)
	STM32F358xx		USART1/USART2/ I2C1	0x50	0x1FFFF796	USART (V3.1) I2C (V1.0)
	STM32F301xx/302x4(6/8)		USART1/USART2/ DFU (USB Device FS)	0x40	0x1FFFF796	USART (V3.1) DFU (V2.2)
	STM32F318xx		USART1/USART2/ I2C1/ I2C3	0x50	0x1FFFF796	USART (V3.1) I2C (V1.0)
	STM32F302xD(E)/303xD(E)		USART1/USART2/ DFU (USB Device FS)	0x40	0x1FFFF796	USART (V3.1) DFU (V2.2)
	STM32F303x4(6/8)/334xx/328xx		USART1/USART2/ I2C1	0x50	0x1FFFF796	USART (V3.1) I2C (V1.0)
	STM32F398xx		USART1/USART2/ I2C1/I2C3	0x50	0x1FFFF796	USART (V3.1) I2C (V1.0)

Table 3. Embedded bootloaders (continued)

STM32 series	Device	Supported serial peripherals	Bootloader ID		Bootloader (protocol) version
			ID	Memory location	
F4	STM32F40xxx/41xxx	USART1/USART3/ CAN2/ DFU (USB Device FS)	0x31	0x1FFF77DE	USART (V3.1) CAN (V2.0) DFU (V2.2)
		USART1/USART3/ CAN2 / DFU (USB Device FS) / I2C1/I2C2/I2C3/SPI1/SPI2	0x90	0x1FFF77DE	USART (V3.1) CAN (V2.0) DFU (V2.2) SPI(V1.1) I2C (V1.0)
	STM32F42xxx/43xxx	USART1/USART3/ CAN2 /DFU (USB Device FS) / I2C1/I2C2/I2C3	0x70	0x1FFF76DE	USART (V3.1) CAN (V2.0) DFU (V2.2) I2C (V1.0)
		USART1/USART3/ CAN2 / DFU (USB Device FS) / I2C1/I2C2/I2C3/SPI1/ SPI2/ SPI4	0x90	0x1FFF76DE	USART (V3.1) CAN (V2.0) DFU (V2.2) SPI(V1.1) I2C (V1.0)
	STM32F401xB(C)	USART1/USART2/ DFU (USB Device FS)/ I2C1/I2C2/I2C3/ SPI1/SPI2/ SPI3	0xD1	0x1FFF76DE	USART (V3.1) DFU (V2.2) SPI(V1.1) I2C (V1.0)
	STM32F401xD(E)	USART1/USART2/ DFU (USB Device FS)/ I2C1/I2C2/I2C3/ SPI1/SPI2/ SPI3	0xD1	0x1FFF76DE	USART (V3.1) DFU (V2.2) SPI(V1.1) I2C (V1.1)
	STM32F410xx	USART1/USART2/ I2C1/I2C2/I2C4 SPI1/SPI2	0xB1	0x1FFF76DE	USART (V3.1) I2C (V1.2) SPI (V1.1)
	STM32F411xx	USART1/USART2/ DFU (USB Device FS)/ I2C1/I2C2/I2C3/ SPI1/SPI2/ SPI3	0xD0	0x1FFF76DE	USART (V3.1) DFU (V2.2) SPI(V1.1) I2C (V1.1)
	STM32F412xx	USART1/USART2/ USART3/CAN2/ DFU (USB Device FS)/ I2C1/I2C2/I2C3/I2C4/ SPI1/SPI3/SPI4	0x91	0x1FFF76DE	USART (V3.1) CAN (V2.0) DFU (V2.2) SPI (V1.1) I2C (V1.2)
	STM32F446xx	USART1/USART3/ CAN2 / DFU (USB Device FS) / I2C1/I2C2/I2C3/SPI1/ SPI2/ SPI4	0x90	0x1FFF76DE	USART (V3.1) CAN (V2.0) DFU (V2.2) SPI(V1.1) I2C (V1.2)
	STM32F469xx/479xx	USART1/USART3/ I2C1/I2C2/I2C3/ CAN2/ DFU (USB Device FS)/ SPI1/ SPI2/ SPI4	0x90	0x1FFF76DE	USART (V3.1) I2C (V1.2) CAN (V2.0) DFU (V2.2) SPI (V1.1)

Table 3. Embedded bootloaders (continued)

STM32 series	Device	Supported serial peripherals	Bootloader ID		Bootloader (protocol) version
			ID	Memory location	
F7	STM32F74xxx/75xxx	USART1/USART3/ I2C1/I2C2/I2C3/ CAN2/ DFU (USB Device FS)	0x70	0x1FF0EDBE	USART (V3.1) I2C (V1.2) CAN (V2.0) DFU (V2.2)
		USART1/USART3/ I2C1/I2C2/I2C3/ CAN2/ DFU (USB Device FS)/ SPI1/SPI2/SPI4	0x90	0x1FF0EDBE	USART (V3.1) I2C (V1.2) CAN (V2.0) DFU (V2.2) SPI (V1.2)
	STM32F76xxx/77xxx	USART1/USART3/ CAN2/ DFU (USB Device FS)/ I2C1/I2C2/I2C3/ SPI1/SPI2/SPI4	0x93	0x1FF0EDBE	USART (V3.1) CAN (V2.0) DFU (V2.2) I2C (V1.2) SPI (V1.2)
L0	STM32L01xxx/02xxx	USART2/SPI1	0xC3	0x1FF00FFE	USART (V3.1) SPI (V1.1)
	STM32L031xx/041xx	USART2/SPI1	0xC0	0x1FF00FFE	USART (V3.1) SPI (V1.1)
	STM32L05xxx/06xxx	USART1/USART2/SPI1/ SPI2	0xC0	0x1FF00FFE	USART (V3.1) SPI (V1.1)
	STM32L07xxx/08xxx	USART1/USART2/ DFU (USB Device FS)	0x41	0x1FF01FFE	USART (V3.1) DFU (V2.2)
		USART1/USART2/ SPI1/SPI2/	0xB2	0x1FF01FFE	USART (V3.1) SPI (V1.1)
L1	STM32L1xxx6(8/B)	USART1/USART2	0x20	0x1FF00FFE	USART (V3.0)
	STM32L1xxx6(8/B)A	USART1/USART2	0x20	0x1FF00FFE	USART (V3.1)
	STM32L1xxxC	USART1/USART2/ DFU (USB Device FS)	0x40	0x1FF01FFE	USART (V3.1) DFU (V2.2)
	STM32L1xxxD	USART1/USART2/ DFU (USB Device FS)	0x45	0x1FF01FFE	USART (V3.1) DFU (V2.2)
	STM32L1xxxE	USART1/USART2/ DFU (USB Device FS)	0x40	0x1FF01FFE	USART (V3.1) DFU (V2.2)

Table 3. Embedded bootloaders (continued)

STM32 series	Device	Supported serial peripherals	Bootloader ID		Bootloader (protocol) version
			ID	Memory location	
L4	STM32L476xx/486xx	USART1/USART2/ USART3/ I2C1/I2C2/I2C3/ DFU (USB Device FS)	0xA3	0x1FFF6FFE	USART (V3.1) I2C (V1.2) DFU (V2.2)
		USART1/USART2/ USART3/ I2C/I2C2/I2C3/ SPI1/SPI2/CAN1/ DFU (USB Device FS)	0x90	0x1FFF6FFE	USART (V3.1) I2C (V1.2) SPI (V1.1) CAN(V2.0) DFU(V2.2)
	STM32L43xx/44xx	USART1/USART2/ I2C1/I2C2/I2C3/ CAN1/ DFU (USB Device FS)/ SPI1/SPI2	0x91	0x1FFF6FFE	USART (V3.1) I2C (V1.2) CAN (V2.0) DFU (V2.2) SPI (V1.1)

1. For connectivity line devices, the USART bootloader returns V2.0 instead of V2.2 for the protocol version. For more details please refer to the "STM32F105xx and STM32F107xx revision Z" errata sheet available from <http://www.st.com>.

3.3 Hardware connection requirements

To use the USART bootloader, the host has to be connected to the (RX) and (TX) pins of the desired USARTx interface via a serial cable.

Figure 1. USART Connection

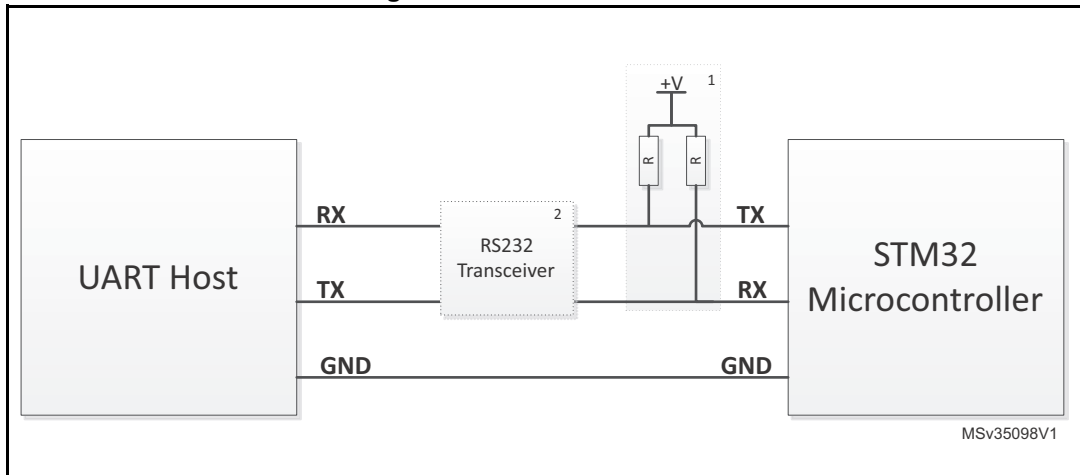

1. A Pull-UP resistor should be added, if pull-up resistor are not connected in host side.
2. An RS232 transceiver must be connected to adapt voltage level (3.3V - 12V) between STM32 device and host.

Note: +V typically 3.3 V and R value typically 100KOhm. This value depend on the application and the used hardware.

To use the DFU, connect the microcontroller's USB interface to a USB host (i.e. PC).

Figure 2. USB Connection

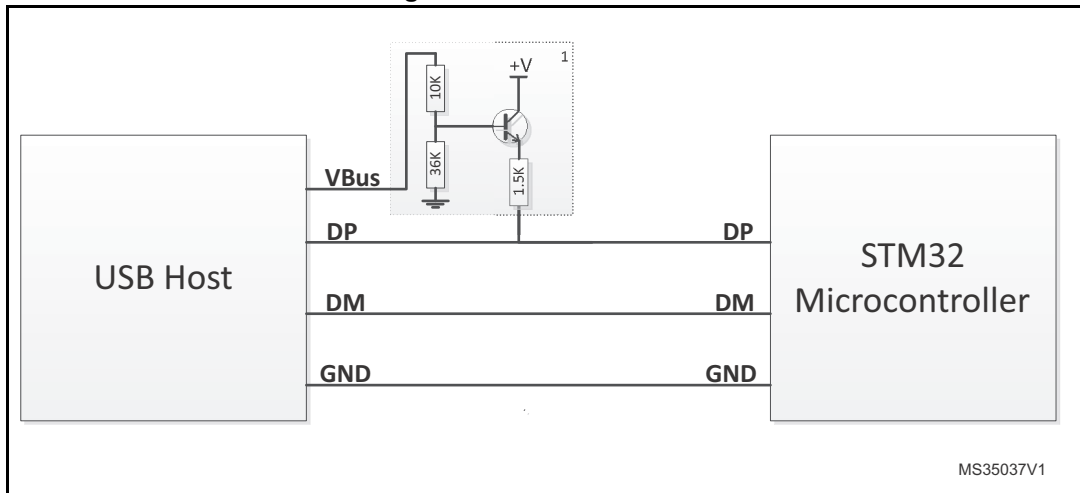

1. This additional circuit permits to connect a Pull-Up resistor to (DP) pin using VBus when needed. Refer to product section (Table which describes STM32 Configuration in system memory boot mode) to know if an external pull-up resistor must be connected to (DP) pin.

Note: +V typically 3.3 V. This value depends on the application and the used hardware.

To use the I2C bootloader, connect the host (master) and the desired I2Cx interface (slave) together via the data (SDA) and clock (SCL) pins. A 1.8 KOhm pull-up resistor has to be connected to both (SDA) and (SCL) lines.

Figure 3. I2C Connection

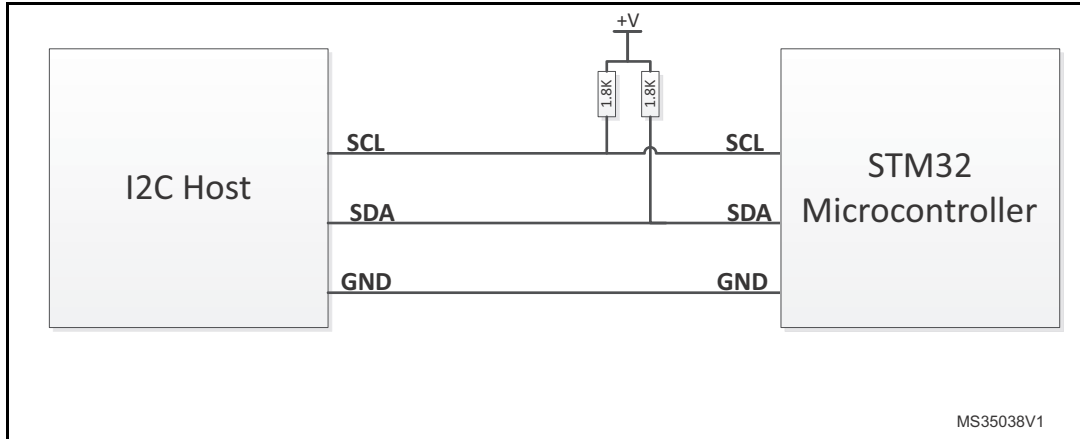

Note: +V typically 3.3 V. This value depends on the application and the used hardware.

To use the SPI bootloader, connect the host (master) and the desired SPIx interface (slave) together via the (MOSI), (MISO) and (SCK) pins. The (NSS) pin must be connected to (GND). A pull-down resistor should be connected to the (SCK) line.

Figure 4. SPI Connection

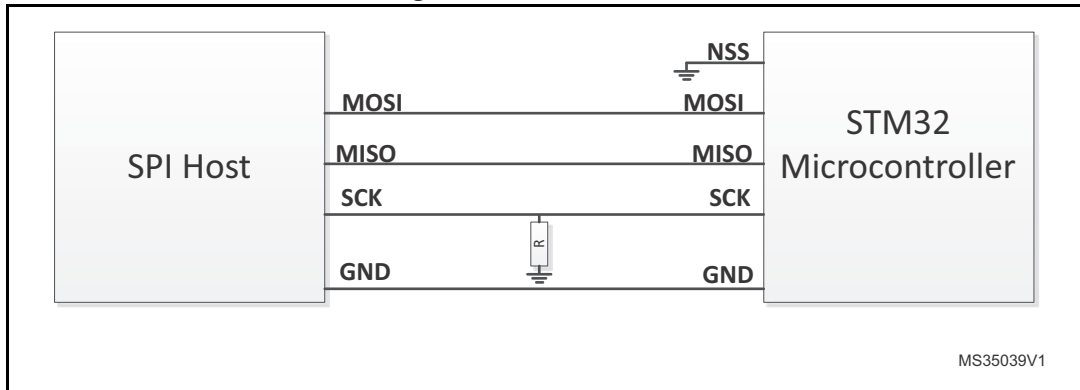

Note: R value typically 10KOhm. This value depends on the application and the used hardware.

To use the CAN interface, the host has to be connected to the (RX) and (TX) pins of the desired CANx interface via CAN transceiver and a serial cable. A 120 Ohm resistor should be added as terminating resistor.

Figure 5. CAN Connection

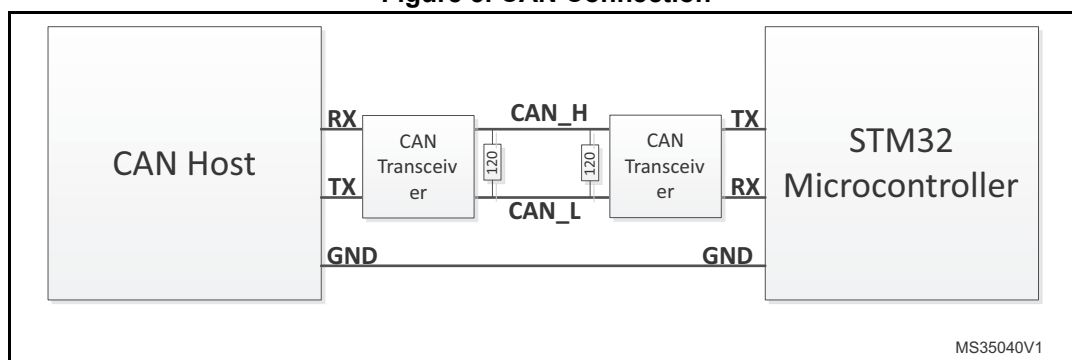

Note: When a bootloader firmware supports DFU, it is mandatory that no USB Host is connected to the USB peripheral during the selection phase of the other interfaces. After selection phase, the user can plug a USB cable without impacting the selected bootloader execution except commands which generate a system reset.

It is recommended to keep the RX pins of unused Bootloader interfaces (USART_RX, SPI_MOSI, CAN_RX and USB D+/D- lines if present) at a known (low or high) level at the startup of the Bootloader (detection phase). Leaving these pins floating during the detection phase might lead to activating unused interface.

3.4 Bootloader Memory Management

All write operations using bootloader commands must only be Word-aligned (the address should be a multiple of 4). The number of data to be written must also be a multiple of 4 (non-aligned half page write addresses are accepted).

Some Products embed bootloader that has some specific features:

- Some products don't support Mass erase operation. To perform a mass erase operation using bootloader, two options are available:
 - Erase all sectors one by one using the Erase command
 - Set protection level to Level 1. Then, set it to Level 0 (using the Read protect command and then the Read Unprotect command). This operation results in a mass erase of the internal Flash memory.
- Bootloader firmware of STM32 L1 and L0 series supports Data Memory in addition to standard memories (internal Flash, internal SRAM, option bytes and System memory). The start address and the size of this area depends on product, please refer to product reference manual for more information. Data memory can be read and written but cannot be erased using the Erase Command. When writing in a Data memory location, the bootloader firmware manages the erase operation of this location before any write. A write to Data memory must be Word-aligned (address to be written should be a multiple of 4) and the number of data must also be a multiple of 4. To erase a Data memory location, you can write zeros at this location.
- Bootloader firmware of STM32 F2, F4, F7 and L4 series supports OTP memory in addition to standard memories (internal Flash, internal SRAM, option bytes and System memory). The start address and the size of this area depends on product, please refer to product reference manual for more information. OTP memory can be read and

written but cannot be erased using Erase command. When writing in an OTP memory location, make sure that the relative protection bit is not reset.

- For STM32 F2, F4 and F7 series the internal flash write operation format depends on voltage Range. By default write operation are allowed by one byte format (Half-Word, Word and Double-Word operations are not allowed). to increase the speed of write operation, the user should apply the adequate voltage range that allows write operation by Half-Word, Word or Double-Word and update this configuration on the fly by the bootloader software through a virtual memory location. This memory location is not physical but can be read and written using usual bootloader read/write operations according to the protocol in use. This memory location contains 4 bytes which are described in table below. It can be accessed by 1, 2, 3 or 4 bytes. However, reserved bytes should remain at their default values (0xFF), otherwise the request will be NACKed.

Table 4. STM32 F2, F4 and F7 Voltage Range configuration using bootloader

Address	Size	Description
0xFFFF0000	1 byte	This byte controls the current value of the voltage range. 0x00: voltage range [1.8 V, 2.1 V] 0x01: voltage range [2.1 V, 2.4 V] 0x02: voltage range [2.4 V, 2.7 V] 0x03: voltage range [2.7 V, 3.6 V] 0x04: voltage range [2.7 V, 3.6 V] and double word write/erase operation is used. In this case it is mandatory to supply 9 V through the VPP pin (refer to the product reference manual for more details about the double-word write procedure). Other: all other values are not supported and will be NACKed.
0xFFFF0001	1 byte	Reserved. 0xFF: default value. Other: all other values are not supported and will be NACKed.
0xFFFF0002	1 byte	Reserved. 0xFF: default value. Other: all other values are not supported and will be NACKed.
0xFFFF0003	1 byte	Reserved. 0xFF: default value. Other: all other values are not supported and will be NACKed.

The table below lists the valid memory area depending on the Bootloader commands.

Table 5. Supported memory area by Write, Read, Erase and Go Commands

Memory Area	Write command	Read command	Erase command	Go command
Flash	Supported	Supported	Supported	Supported
RAM	Supported	Supported	Not Supported	Supported
System Memory	Not Supported	Supported	Not Supported	Not Supported
Data Memory	Supported	Supported	Not Supported	Not Supported
OTP Memory	Supported	Supported	Not Supported	Not Supported

4 STM32F03xx4/6 devices bootloader

4.1 Bootloader configuration

The STM32F03xx4/6 bootloader is activated by applying pattern2 (described in [Table 2: Bootloader activation patterns](#)). The following table shows the hardware resources used by this bootloader.

Table 6. STM32F03xx4/6 configuration in system memory boot mode

Bootloader	Feature/Peripheral	State	Comment
Common to all bootloaders	RCC	HSI Enabled	The system clock frequency is 24 MHz (using PLL clocked by HSI). 1 Flash Wait State.
	RAM	-	2 Kbyte starting from address 0x20000000 are used by the bootloader firmware.
	System memory	-	3 Kbyte starting from address 0x1FFFE000 contain the bootloader firmware.
	IWDG	-	The independent watchdog (IWDG) prescaler is configured to its maximum value. It is periodically refreshed to prevent watchdog reset in case the hardware IWDG option was previously enabled by the user.
USART1 bootloader (on PA10/PA9)	USART1	Enabled	Once initialized, the USART1 configuration is 8 bits, even parity and 1 Stop bit.
	USART1_RX pin	Input	PA10 pin: USART1 in reception mode.
	USART1_TX pin	Output	PA9 pin: USART1 in transmission mode.
USART1 bootloader (on PA14/PA15)	USART1	Enabled	Once initialized, the USART1 configuration is 8 bits, even parity and 1 Stop bit.
	USART1_RX pin	Input	PA15 pin: USART1 in reception mode.
	USART1_TX pin	Output	PA14 pin: USART1 in transmission mode.
USART1 bootloaders	SysTick timer	Enabled	Used to automatically detect the serial baud rate from the host.

The system clock is derived from the embedded internal high-speed RC, no external quartz is required for the bootloader execution.

Note: After the STM32F03xx4/6 devices has booted in bootloader mode, serial wire debug (SWD) communication is no longer possible until the system is reset. This is because the SWD uses the PA14 pin (SWCLK) which is already used by the bootloader (USART1_TX).

4.2 Bootloader selection

The figure below shows the bootloader selection mechanism.

Figure 6. Bootloader selection for STM32F03xx4/6 devices

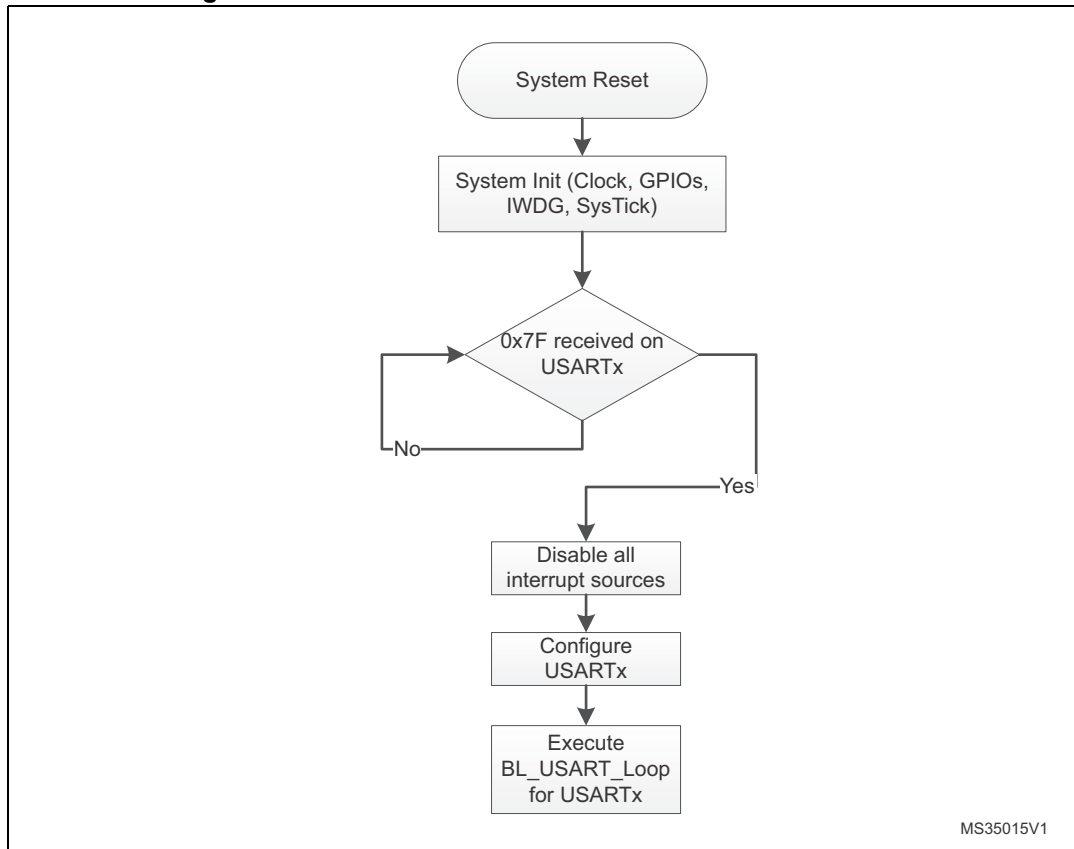

4.3 Bootloader version

The following table lists the STM32F03xx4/6 devices bootloader versions.

Table 7. STM32F03xx4/6 bootloader versions

Bootloader version number	Description	Known limitations
V1.0	Initial bootloader version	For the USART interface, two consecutive NACKs instead of 1 NACK are sent when a Read Memory or Write Memory command is sent and the RDP level is active.

5 STM32F030xC devices bootloader

5.1 Bootloader configuration

The STM32F030xC bootloader is activated by applying pattern6 (described in [Table 2: Bootloader activation patterns](#)). The following table shows the hardware resources used by this bootloader.

Table 8. STM32F030xC configuration in system memory boot mode

Bootloader	Feature/Peripheral	State	Comment
Common to all bootloaders	RCC	HSI enabled	The system clock frequency is 48 MHz with HSI 8 MHz as clock source.
	RAM	-	6 Kbyte starting from address 0x20000000 are used by the bootloader firmware
	System memory	-	8 Kbyte starting from address 0x1FFFD800, contain the bootloader firmware.
USART1 bootloader	USART1	Enabled	Once initialized the USART1 configuration is: 8-bits, even parity and 1 Stop bit
	USART1_RX pin	Input	PA10 pin: USART1 in reception mode
	USART1_TX pin	Output	PA9 pin: USART1 in transmission mode
USART2 bootloader	USART2	Enabled	Once initialized the USART2 configuration is: 8-bits, even parity and 1 Stop bit
	USART2_RX pin	Input	PA15 pin: USART2 in reception mode
	USART2_TX pin	Output	PA14 pin: USART2 in transmission mode
USARTx bootloaders	SysTick timer	Enabled	Used to automatically detect the serial baud rate from the host for USARTx bootloaders.
I2C1 bootloader	I2C1	Enabled	The I2C1 configuration is: I2C speed: up to 400 KHz, 7-bit address, slave mode, analog filter ON. Slave 7-bit address: 0b1000001x (where x = 0 for write and x = 1 for read)
	I2C1_SCL pin	Input/Output	PB6 pin: clock line is used in open-drain mode.
	I2C1_SDA pin	Input/Output	PB7 pin: data line is used in open-drain mode.

Note: After the STM32F030xC devices have booted in Bootloader mode using USART2, the serial wire debug (SWD) communication is no more possible until the system is reset, because SWD uses PA14 pin (SWCLK) which is already used by the Bootloader (USART2_RX).

The system clock is derived from the embedded internal high-speed RC, no external quartz is required for the bootloader execution.

5.2 Bootloader selection

The figure below shows the bootloader selection mechanism.

Figure 7.Bootloader selection for STM32F030xC

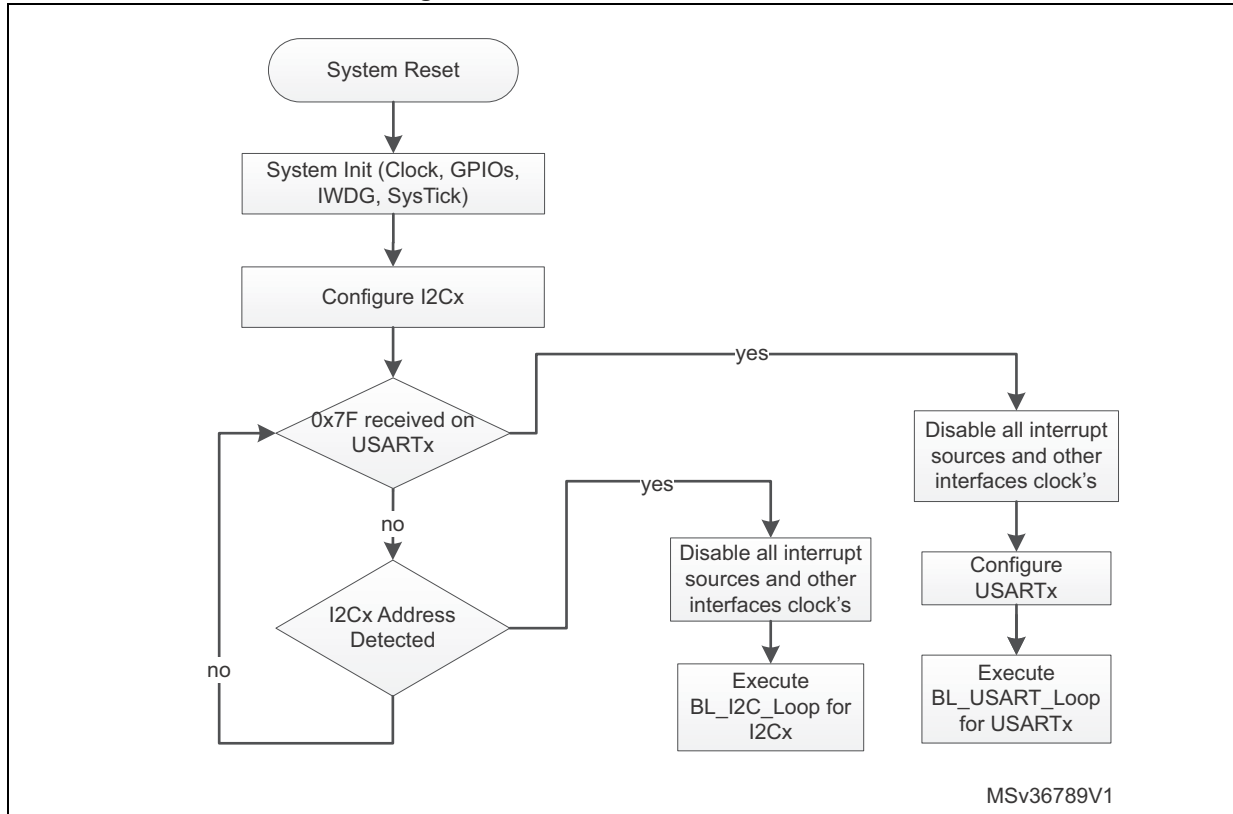

5.3 Bootloader version

The following table lists the STM32F030xC devices bootloader versions.

Table 9.STM32F030xC bootloader versions

Bootloader version number	Description	Known limitations
V5.2	Initial bootloader version	None

6 STM32F05xxx and STM32F030x8 devices bootloader

6.1 Bootloader configuration

The STM32F05xxx and STM32F030x8 devices bootloader is activated by applying pattern2 (described in [Table 2: Bootloader activation patterns](#)). The following table shows the hardware resources used by this bootloader.

Table 10. STM32F05xxx and STM32F030x8 devices configuration in system memory boot mode

Bootloader	Feature/Peripheral	State	Comment
Common to all bootloaders	RCC	HSI Enabled	The system clock frequency is 24 MHz (using PLL clocked by HSI). 1 Flash Wait State.
	RAM	-	2 Kbyte starting from address 0x20000000 are used by the bootloader firmware.
	System memory	-	3 Kbyte starting from address 0x1FFFEC00, contain the bootloader firmware.
	IWDG	-	The independent watchdog (IWDG) prescaler is configured to its maximum value. It is periodically refreshed to prevent watchdog reset in case the hardware IWDG option was previously enabled by the user.
USART1 bootloader	USART1	Enabled	Once initialized, the USART1 configuration is 8 bits, even parity and 1 Stop bit.
	USART1_RX pin	Input	PA10 pin: USART1 in reception mode.
	USART1_TX pin	Output	PA9 pin: USART1 in transmission mode.
USART2 bootloader	USART2	Enabled	Once initialized, the USART2 configuration is 8 bits, even parity and 1 Stop bit.
	USART2_RX pin	Input	PA15 pin: USART2 in reception mode.
	USART2_TX pin	Output	PA14 pin: USART2 in transmission mode.
USARTx bootloaders	SysTick timer	Enabled	Used to automatically detect the serial baud rate from the host.

The system clock is derived from the embedded internal high-speed RC, no external quartz is required for the bootloader execution.

Note: After the STM32F05xxx and STM32F030x8 devices have booted in bootloader mode, the serial wire debug (SWD) communication is no more possible until the system is reset, because SWD uses PA14 pin (SWCLK) which is already used by the bootloader (USART2_TX).

6.2 Bootloader selection

The figure below shows the bootloader selection mechanism.

Figure 8. Bootloader selection for STM32F05xxx and STM32F030x8 devices

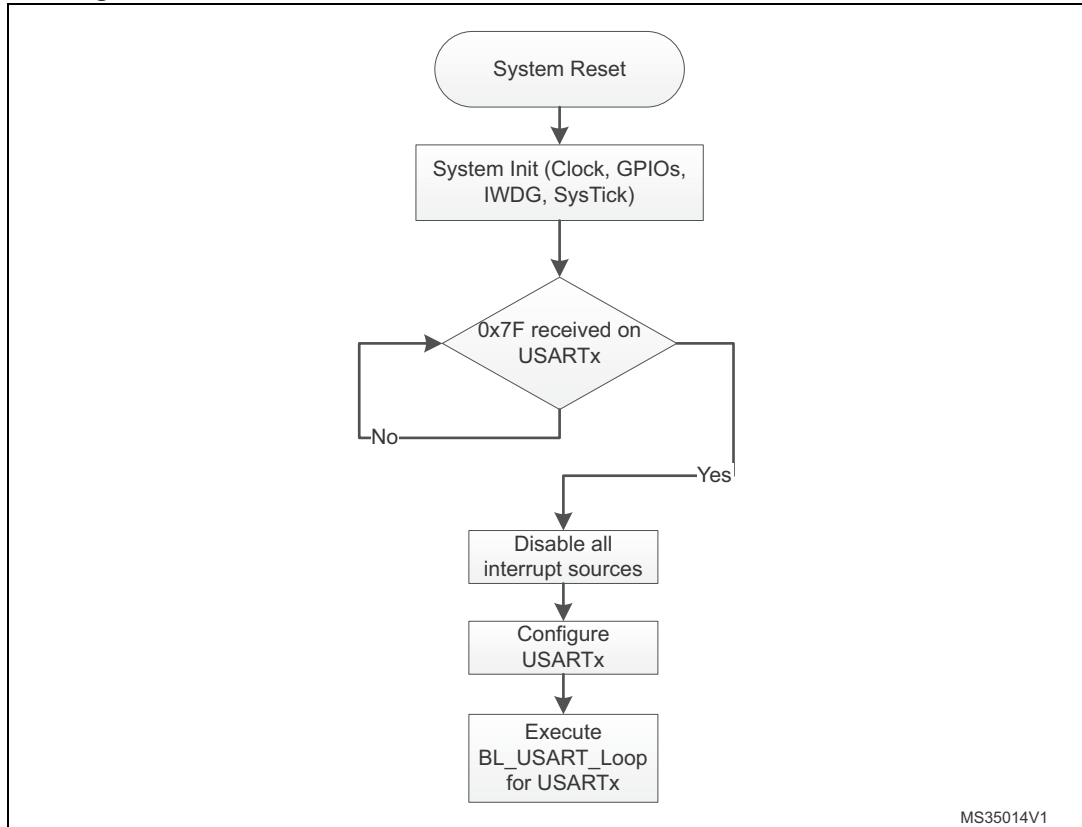

6.3 Bootloader version

The following table lists the STM32F05xxx and STM32F030x8 devices bootloader versions.

Table 11. STM32F05xxx and STM32F030x8 devices bootloader versions

Bootloader version number	Description	Known limitations
V2.1	Initial bootloader version	When the user application configures a value of HSI TRIM bits (in RCC_CR register) and then jumps to the bootloader, the HSITRIM value is set (0) at bootloader startup. For the USART interface, two consecutive NACKs instead of 1 NACK are sent when a Read Memory or Write Memory command is sent and the RDP level is active.

7 STM32F04xxx devices bootloader

7.1 Bootloader configuration

The STM32F04xxx bootloader is activated by applying pattern6 (described in [Table 2: Bootloader activation patterns](#)). The following table shows the hardware resources used by this bootloader.

Table 12. STM32F04xxx configuration in system memory boot mode

Bootloader	Feature/Peripheral	State	Comment
Common to all bootloaders	RCC	HSI enabled	The system clock frequency is 48 MHz with HSI 48 MHz as clock source.
		-	The Clock Recovery System (CRS) is enabled for the DFU bootloaders to allow USB to be clocked by HSI 48 MHz.
	RAM	-	6 Kbyte starting from address 0x20000000 are used by the bootloader firmware
	System memory	-	13 Kbyte starting from address 0x1FFFC400, contain the bootloader firmware
	IWDG	-	The independent watchdog (IWDG) prescaler is configured to its maximum value. It is periodically refreshed to prevent watchdog reset (in case the hardware IWDG option was previously enabled by the user).
USART1 bootloader	USART1	Enabled	Once initialized the USART1 configuration is: 8-bits, even parity and 1 Stop bit
	USART1_RX pin	Input	PA10 pin: USART1 in reception mode
	USART1_TX pin	Output	PA9 pin: USART1 in transmission mode
USART2 bootloader	USART2	Enabled	Once initialized the USART2 configuration is: 8-bits, even parity and 1 Stop bit
	USART2_RX pin	Input	PA15 pin: USART2 in reception mode
	USART2_TX pin	Output	PA14 pin: USART2 in transmission mode
USARTx bootloaders	SysTick timer	Enabled	Used to automatically detect the serial baud rate from the host for USARTx bootloaders.
I2C1 bootloader	I2C1	Enabled	The I2C1 configuration is: I2C speed: up to 400 KHz, 7-bit address, slave mode, analog filter ON. Slave 7-bit address: 0b0111110x (where x = 0 for write and x = 1 for read).
	I2C1_SCL pin	Input/Output	PB6 pin: clock line is used in open-drain mode.
	I2C1_SDA pin	Input/Output	PB7 pin: data line is used in open-drain mode.

Table 12. STM32F04xxx configuration in system memory boot mode (continued)

Bootloader	Feature/Peripheral	State	Comment
DFU bootloader	USB	Enabled	USB used in FS mode
	USB_DM pin	Input/Output	PA11: USB DM line.
	USB_DP pin		PA12: USB DP line No external pull-up resistor is required.

Note: After the STM32F04xxx devices have booted in Bootloader mode using USART2, the serial wire debug (SWD) communication is no more possible until the system is reset, because SWD uses PA14 pin (SWCLK) which is already used by the Bootloader (USART2_RX).

The system clock is derived from the embedded internal high-speed RC, no external quartz is required for the bootloader execution.

Note: User can jump to the System Memory Bootloader from his application code using the following entry point: 0x1FFFC518.

7.2 Bootloader selection

The figure below shows the bootloader selection mechanism.

Figure 9. Bootloader selection for STM32F04xxx

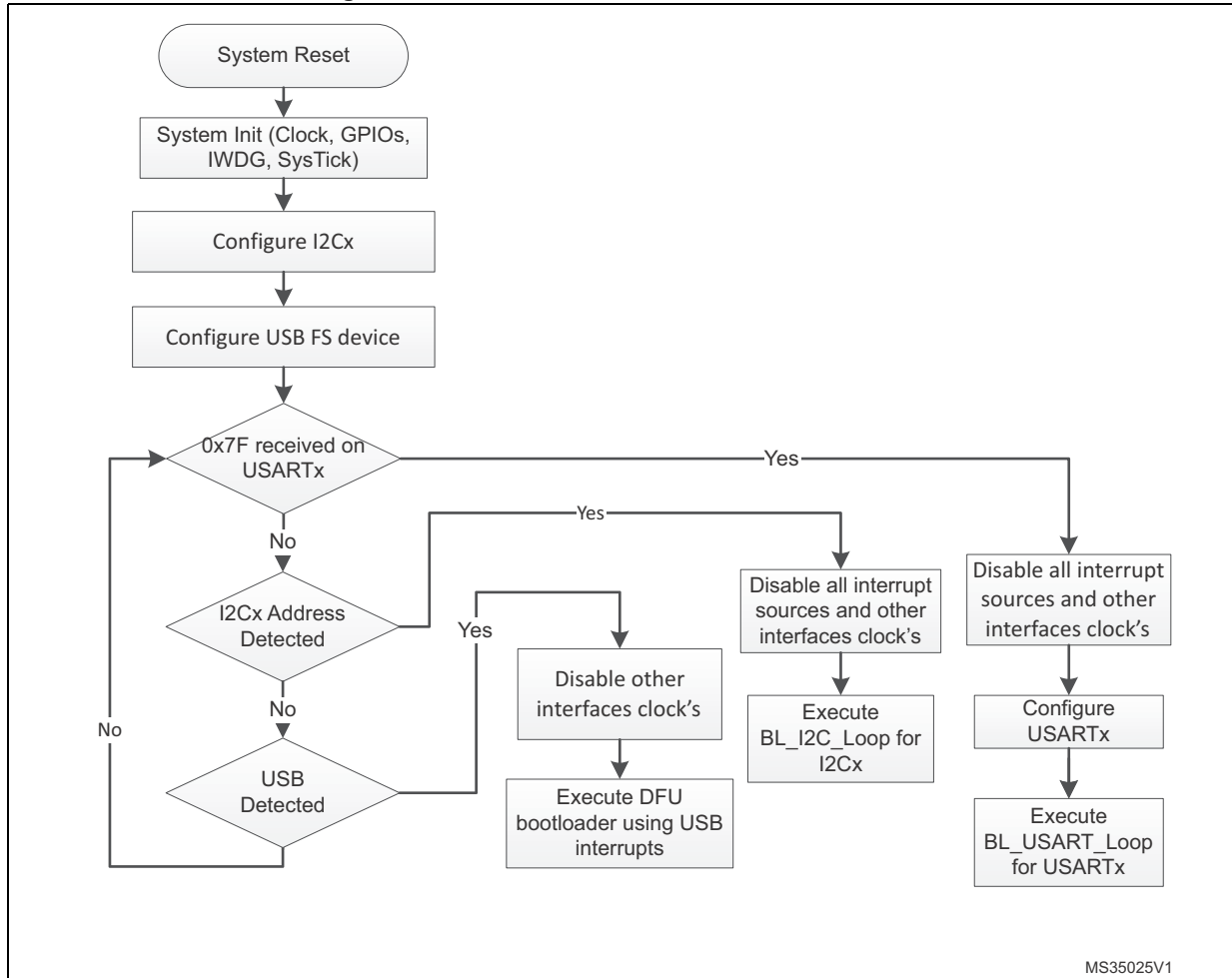

7.3 Bootloader version

The following table lists the STM32F04xxx devices bootloader versions:

Table 13. STM32F04xxx bootloader versions

Bootloader version number	Description	Known limitations
V10.0	Initial bootloader version	When the user application configures a value of HSI TRIM bits (in RCC_CR register) and then jumps to the bootloader, the HSITRIM value is set to (0) at bootloader startup

8 STM32F070x6 devices bootloader

8.1 Bootloader configuration

The STM32F070x6 bootloader is activated by applying pattern6 (described in [Table 2: Bootloader activation patterns](#)). The following table shows the hardware resources used by this bootloader.

Table 14. STM32F070x6 configuration in system memory boot mode

Bootloader	Feature/Peripheral	State	Comment
Common to all bootloaders	RCC	HSI enabled	At startup, the system clock frequency is configured to 48 MHz using the HSI. If an external clock (HSE) is not present, the system is kept clocked from the HSI.
		HSE enabled	The external clock can be used for all bootloader interfaces and should have one of the following values [24,18,12,8,6,4] MHz. The PLL is used to generate 48 MHz for USB and system clock.
		-	The Clock Security System (CSS) interrupt is enabled for HSE. Any failure (or removal) of the external clock generates system reset.
	RAM	-	6 Kbyte starting from address 0x20000000 are used by the bootloader firmware
	System memory	-	13 Kbyte starting from address 0x1FFFC400, contain the bootloader firmware.
USART1 bootloader	USART1	Enabled	Once initialized the USART1 configuration is: 8-bits, even parity and 1 Stop bit
	USART1_RX pin	Input	PA10 pin: USART1 in reception mode
	USART1_TX pin	Output	PA9 pin: USART1 in transmission mode
USART2 bootloader	USART2	Enabled	Once initialized the USART2 configuration is: 8-bits, even parity and 1 Stop bit
	USART2_RX pin	Input	PA15 pin: USART2 in reception mode
	USART2_TX pin	Output	PA14 pin: USART2 in transmission mode
USARTx bootloaders	SysTick timer	Enabled	Used to automatically detect the serial baud rate from the host for USARTx bootloaders.
I2C1 bootloader	I2C1	Enabled	The I2C1 configuration is: I2C speed: up to 400 KHz, 7-bit address, slave mode, analog filter ON. Slave 7-bit address: 0b0111110x where x = 0 for write and x = 1 for read)
	I2C1_SCL pin	Input/Output	PB6 pin: clock line is used in open-drain mode.
	I2C1_SDA pin	Input/Output	PB7 pin: data line is used in open-drain mode.

Table 14. STM32F070x6 configuration in system memory boot mode (continued)

Bootloader	Feature/Peripheral	State	Comment
DFU bootloader	USB	Enabled	USB FS configured in Forced Device mode. USB FS interrupt vector is enabled and used for USB DFU communications.
	USB_DM pin	Input/Output	PA11 pin: USB FS DM line
	USB_DP pin		PA12 pin: USB FS DP line. No external Pull-up resistor is required.

Note: If HSI deviation exceeds 1% , the bootloader might not function correctly.

Note: After the STM32F070x6 devices have booted in Bootloader mode using USART2, the serial wire debug (SWD) communication is no more possible until the system is reset, because SWD uses PA14 pin (SWCLK) which is already used by the Bootloader (USART2_RX).

The bootloader has two cases of operation depending on the presence of the external clock (HSE) at bootloader startup:

- If HSE is present and has a value of 24, 18, 16, 12, 8, 6, 4 MHz, the system clock is configured to 48 MHz with HSE as clock source. The DFU interface, USART1, USART2 and I2C1 are functional and can be used to communicate with the bootloader device.
- If HSE is not present, the HSI is kept as default clock source and only USART1, USART2 and I2C1 are functional.

The external clock (HSE) must be kept if it's connected at bootloader startup because it will be used as system clock source.

Note: User can jump to the System Memory Bootloader from his application code using the following entry point: 0x1FFFC518.

8.2 Bootloader selection

The figure below shows the bootloader selection mechanism.

Figure 10.Bootloader selection for STM32F070x6

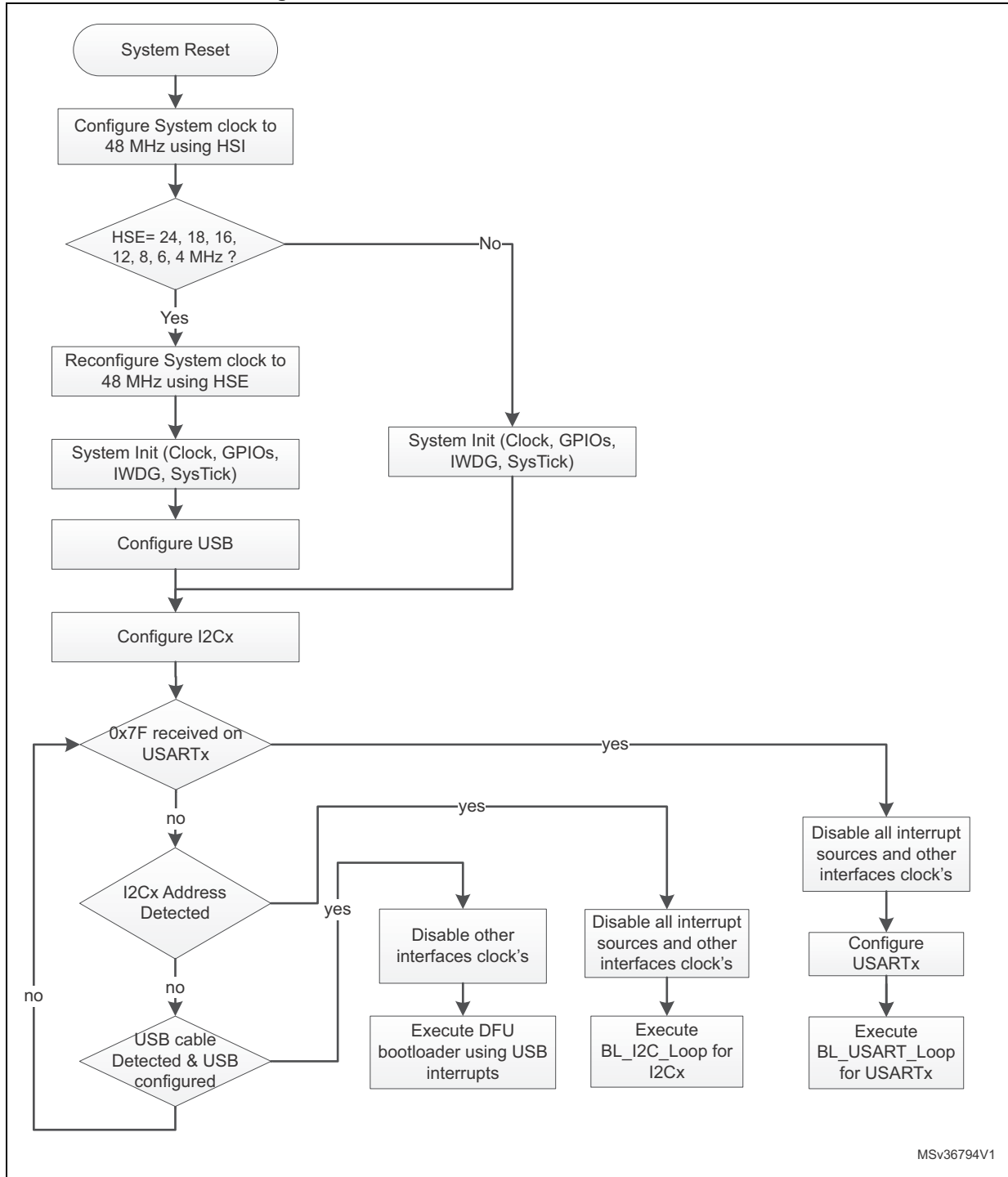

8.3 Bootloader version

The following table lists the STM32F070x6 devices bootloader versions.

Table 15. STM32F070x6 bootloader versions

Bootloader version number	Description	Known limitations
V10.2	Initial bootloader version	When the user application configures a value of HSI TRIM bits (in RCC_CR register) and then jumps to the bootloader, the HSITRIM value is set to (0) at bootloader startup.
V10.3	Clock configuration fixed to HSI 8 MHz	When the user application configures a value of HSI TRIM bits (in RCC_CR register) and then jumps to the bootloader, the HSITRIM value is set to (0) at bootloader startup.

9 STM32F070xB devices bootloader

9.1 Bootloader configuration

The STM32F070xB bootloader is activated by applying pattern2 (described in [Table 2: Bootloader activation patterns](#)). The following table shows the hardware resources used by this bootloader.

Table 16. STM32F070xB configuration in system memory boot mode

Bootloader	Feature/Peripheral	State	Comment
Common to all bootloaders	RCC	HSI enabled	At startup, the system clock frequency is configured to 48 MHz using the HSI. If an external clock (HSE) is not present, the system is kept clocked from the HSI.
		HSE enabled	The external clock can be used for all bootloader interfaces and should have one of the following values [24,18,12,8,6,4] MHz. The PLL is used to generate 48 MHz for USB and system clock.
		-	The Clock Security System (CSS) interrupt is enabled for HSE. Any failure (or removal) of the external clock generates system reset.
	RAM	-	6 Kbyte starting from address 0x20000000 are used by the bootloader firmware
	System memory	-	12 Kbyte starting from address 0x1FFFC800, contain the bootloader firmware.
USART1 bootloader	USART1	Enabled	Once initialized the USART1 configuration is: 8-bits, even parity and 1 Stop bit
	USART1_RX pin	Input	PA10 pin: USART1 in reception mode
	USART1_TX pin	Output	PA9 pin: USART1 in transmission mode
USART2 bootloader	USART2	Enabled	Once initialized the USART2 configuration is: 8-bits, even parity and 1 Stop bit
	USART2_RX pin	Input	PA15 pin: USART2 in reception mode
	USART2_TX pin	Output	PA14 pin: USART2 in transmission mode
USARTx bootloaders	SysTick timer	Enabled	Used to automatically detect the serial baud rate from the host for USARTx bootloaders.
I2C1 bootloader	I2C1	Enabled	The I2C1 configuration is: I2C speed: up to 400 KHz, 7-bit address, slave mode, analog filter ON. Slave 7-bit address: 0b0111011x (where x = 0 for write and x = 1 for read)
	I2C1_SCL pin	Input/Output	PB6 pin: clock line is used in open-drain mode.
	I2C1_SDA pin	Input/Output	PB7 pin: data line is used in open-drain mode.

Table 16. STM32F070xB configuration in system memory boot mode (continued)

Bootloader	Feature/Peripheral	State	Comment
DFU bootloader	USB	Enabled	USB FS configured in Forced Device mode. USB FS interrupt vector is enabled and used for USB DFU communications.
	USB_DM pin	Input/Output	PA11 pin: USB FS DM line
	USB_DP pin		PA12 pin: USB FS DP line. No external Pull-up resistor is required.

Note: If HSI deviation exceeds 1% , the bootloader might not function correctly.

Note: After the STM32F070xB devices have booted in Bootloader mode using USART2, the serial wire debug (SWD) communication is no more possible until the system is reset, because SWD uses PA14 pin (SWCLK) which is already used by the Bootloader (USART2_RX).

The bootloader has two cases of operation depending on the presence of the external clock (HSE) at bootloader startup:

- If HSE is present and has a value of 24, 18, 16, 12, 8, 6, 4 MHz, the system clock is configured to 48 MHz with HSE as clock source. The DFU interface, USART1, USART2 and I2C1 are functional and can be used to communicate with the bootloader device.
- If HSE is not present, the HSI is kept as default clock source and only USART1, USART2 and I2C1 are functional.

The external clock (HSE) must be kept if it's connected at bootloader startup because it will be used as system clock source.

9.2 Bootloader selection

The figure below shows the bootloader selection mechanism.

Figure 11.Bootloader selection for STM32F070xB

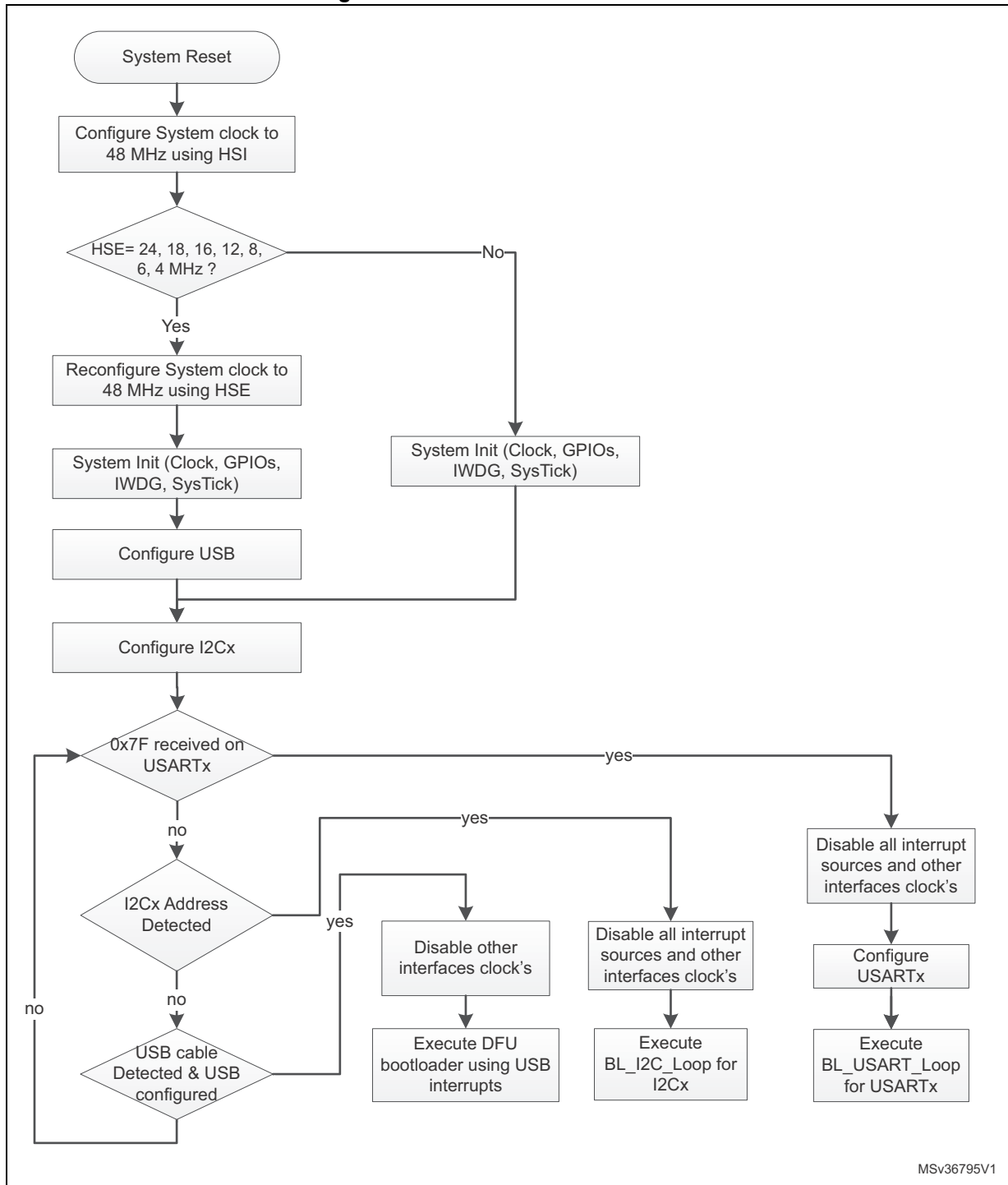

9.3 Bootloader version

The following table lists the STM32F070xB devices bootloader versions.

Table 17. STM32F070xB bootloader versions

Bootloader version number	Description	Known limitations
V10.2	Initial bootloader version	When the user application configures a value of HSI TRIM bits (in RCC_CR register) and then jumps to the bootloader, the HSITRIM value is set to (0) at bootloader startup.
V10.3	Clock configuration fixed to HSI 8 MHz	When the user application configures a value of HSI TRIM bits (in RCC_CR register) and then jumps to the bootloader, the HSITRIM value is set to (0) at bootloader startup.

10 STM32F071xx/72xx devices bootloader

10.1 Bootloader configuration

The STM32F071xx/72xx bootloader is activated by applying pattern2 (described in [Table 2: Bootloader activation patterns](#)). The following table shows the hardware resources used by this bootloader.

Table 18. STM32F071xx/72xx configuration in system memory boot mode

Bootloader	Feature/Peripheral	State	Comment
Common to all bootloaders	RCC	HSI enabled	The system clock frequency is 48 MHz with HSI 48 MHz as clock source.
		-	The Clock Recovery System (CRS) is enabled for the DFU bootloaders to allow USB to be clocked by HSI 48 MHz.
	RAM	-	6 Kbyte starting from address 0x20000000 are used by the bootloader firmware
	System memory	-	12 Kbyte starting from address 0x1FFFC800, contain the bootloader firmware
	IWDG	-	The independent watchdog (IWDG) prescaler is configured to its maximum value. It is periodically refreshed to prevent watchdog reset (in case the hardware IWDG option was previously enabled by the user).
USART1 bootloader	USART1	Enabled	Once initialized the USART1 configuration is: 8-bits, even parity and 1 Stop bit
	USART1_RX pin	Input	PA10 pin: USART1 in reception mode
	USART1_TX pin	Output	PA9 pin: USART1 in transmission mode
USART2 bootloader	USART2	Enabled	Once initialized the USART2 configuration is: 8-bits, even parity and 1 Stop bit
	USART2_RX pin	Input	PA15 pin: USART2 in reception mode
	USART2_TX pin	Output	PA14 pin: USART2 in transmission mode
USARTx bootloaders	SysTick timer	Enabled	Used to automatically detect the serial baud rate from the host for USARTx bootloaders.
I2C1 bootloader	I2C1	Enabled	The I2C1 configuration is: I2C speed: up to 400 KHz, 7-bit address, slave mode, analog filter ON. Slave 7-bit address: 0b0111011x (where x = 0 for write and x = 1 for read)
	I2C1_SCL pin	Input/Output	PB6 pin: clock line is used in open-drain mode.
	I2C1_SDA pin	Input/Output	PB7 pin: data line is used in open-drain mode.

Table 18. STM32F071xx/72xx configuration in system memory boot mode (continued)

Bootloader	Feature/Peripheral	State	Comment
DFU bootloader	USB	Enabled	USB used in FS mode
	USB_DM pin	Input/Output	PA11: USB DM line.
	USB_DP pin		PA12: USB DP line No external pull-up resistor is required.

Note: After the STM32F071xx/72xx devices have booted in Bootloader mode using USART2, the serial wire debug (SWD) communication is no more possible until the system is reset, because SWD uses PA14 pin (SWCLK) which is already used by the Bootloader (USART2_RX).

The system clock is derived from the embedded internal high-speed RC, no external quartz is required for the bootloader execution.

10.2 Bootloader selection

The figure below shows the bootloader selection mechanism.

Figure 12. Bootloader selection for STM32F071xx/72xx

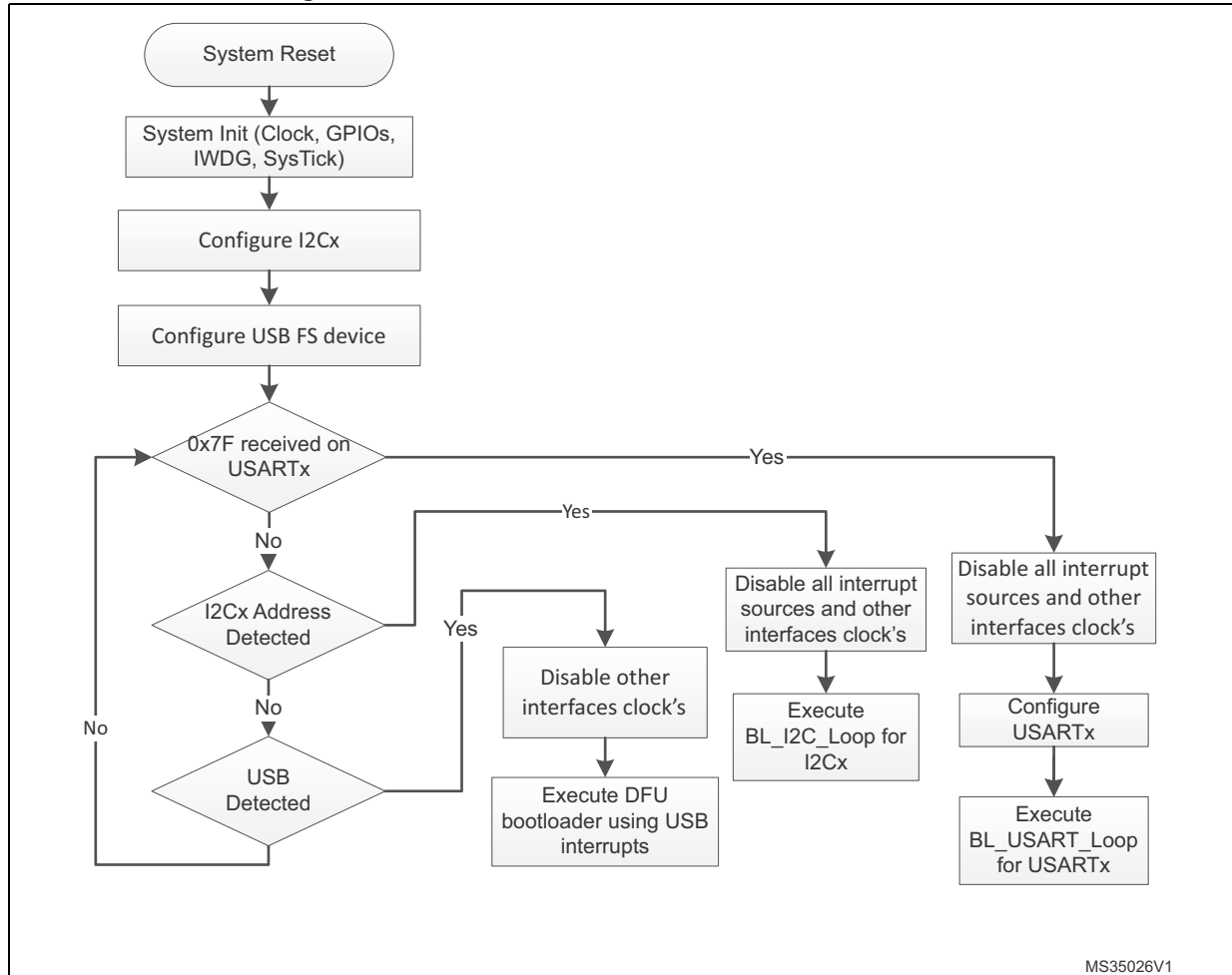

10.3 Bootloader version

The following table lists the STM32F071xx/72xx devices bootloader versions:

Table 19. STM32F071xx/72xx bootloader versions

Bootloader version number	Description	Known limitations
V10.1	Initial bootloader version	When the user application configures a value of HSI TRIM bits (in RCC_CR register) and then jumps to the bootloader, the HSITRIM value is set to (0) at bootloader startup

11 STM32F09xxx devices bootloader

11.1 Bootloader configuration

The STM32F09xxx bootloader is activated by applying pattern6 (described in [Table 2: Bootloader activation patterns](#)). The following table shows the hardware resources used by this bootloader.

Table 20. STM32F09xxx configuration in system memory boot mode

Bootloader	Feature/Peripheral	State	Comment
Common to all bootloaders	RCC	HSI enabled	The system clock frequency is 48 MHz with HSI 48 MHz as clock source.
	RAM	-	6 Kbyte starting from address 0x20000000 are used by the bootloader firmware
	System memory	-	8 Kbyte starting from address 0x1FFFD800, contain the bootloader firmware.
USART1 bootloader	USART1	Enabled	Once initialized the USART1 configuration is: 8-bits, even parity and 1 Stop bit
	USART1_RX pin	Input	PA10 pin: USART1 in reception mode
	USART1_TX pin	Output	PA9 pin: USART1 in transmission mode
USART2 bootloader	USART2	Enabled	Once initialized the USART2 configuration is: 8-bits, even parity and 1 Stop bit
	USART2_RX pin	Input	PA15 pin: USART2 in reception mode
	USART2_TX pin	Output	PA14 pin: USART2 in transmission mode
USARTx bootloaders	SysTick timer	Enabled	Used to automatically detect the serial baud rate from the host for USARTx bootloaders.
I2C1 bootloader	I2C1	Enabled	The I2C1 configuration is: I2C speed: up to 400 KHz, 7-bit address, slave mode, analog filter ON. Slave 7-bit address: 0b1000001x (where x = 0 for write and x = 1 for read)
	I2C1_SCL pin	Input/Output	PB6 pin: clock line is used in open-drain mode.
	I2C1_SDA pin	Input/Output	PB7 pin: data line is used in open-drain mode.

Note: After the STM32F09xxx devices have booted in Bootloader mode using USART2, the serial wire debug (SWD) communication is no more possible until the system is reset, because SWD uses PA14 pin (SWCLK) which is already used by the Bootloader (USART2_RX).

The system clock is derived from the embedded internal high-speed RC, no external quartz is required for the bootloader execution.

11.2 Bootloader selection

The figure below shows the bootloader selection mechanism.

Figure 13. Bootloader selection for STM32F09xxx

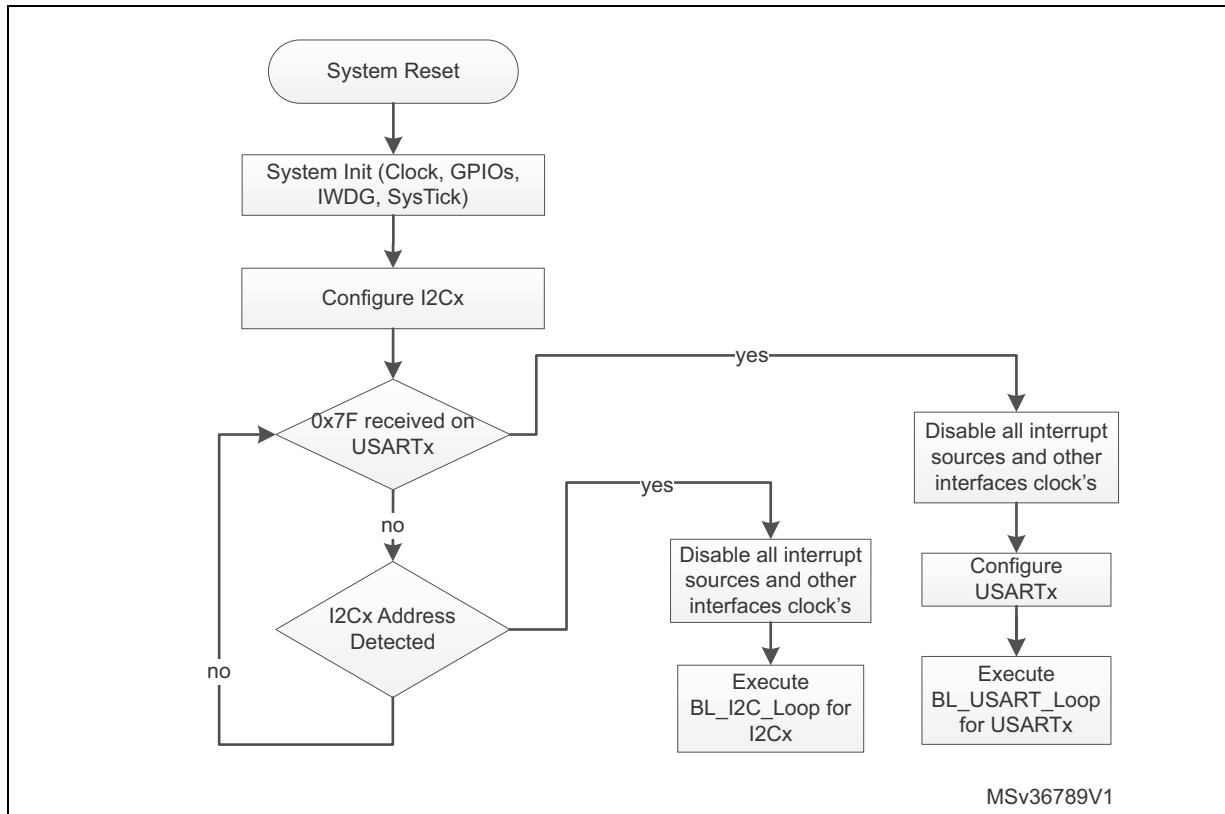

11.3 Bootloader version

The following table lists the STM32F09xxx devices bootloader versions.

Table 21. STM32F09xxx bootloader versions

Bootloader version number	Description	Known limitations
V5.0	Initial bootloader version	When the user application configures a value of HSI TRIM bits (in RCC_CR register) and then jumps to the bootloader, the HSITRIM value is set to (0) at bootloader startup.

12 STM32F10xxx devices bootloader

12.1 Bootloader configuration

The STM32F10xxx bootloader is activated by applying pattern1 (described in [Table 2: Bootloader activation patterns](#)). The following table shows the hardware resources used by this bootloader.

Table 22. STM32F10xxx configuration in system memory boot mode

Bootloader	Feature/Peripheral	State	Comment
USART1 bootloader	RCC	HSI enabled	The system clock frequency is 24 MHz using the PLL.
	RAM	-	512 byte starting from address 0x20000000 are used by the bootloader firmware.
	System memory	-	2 Kbyte starting from address 0x1FFFF000 contain the bootloader firmware.
	IWDG	-	The independent watchdog (IWDG) prescaler is configured to its maximum value and is periodically refreshed to prevent watchdog reset (in case the hardware IWDG option was previously enabled by the user).
	USART1	Enabled	Once initialized, the USART1 configuration is: 8 bits, even parity and 1 Stop bit.
	USART1_RX pin	Input	PA10 pin: USART1 in reception mode
	USART1_TX pin	Output push-pull	PA9 pin: USART1 in transmission mode
	SysTick timer	Enabled	Used to automatically detect the serial baud rate from the host.

The system clock is derived from the embedded internal high-speed RC, no external quartz is required for the bootloader execution.

12.2 Bootloader selection

The figure below shows the bootloader selection mechanism.

Figure 14. Bootloader selection for STM32F10xxx

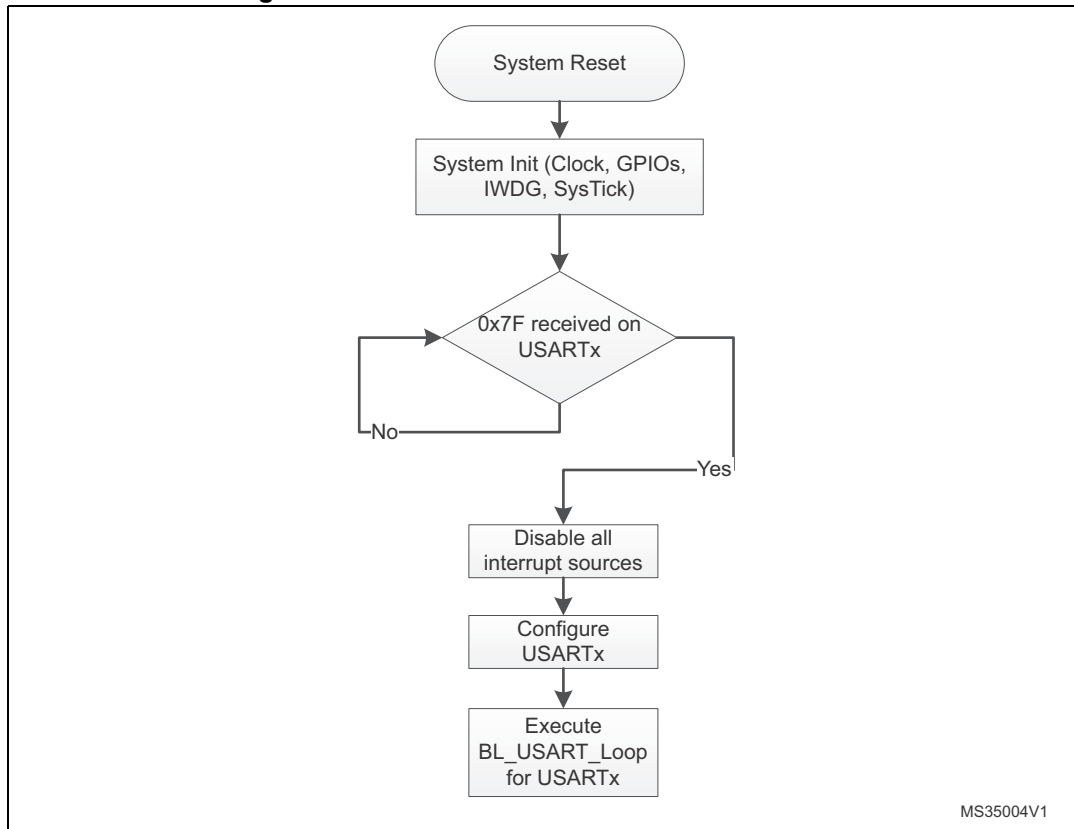

12.3 Bootloader version

The following table lists the STM32F10xxx devices bootloader versions:

Table 23. STM32F10xxx bootloader versions

Bootloader version number	Description
V2.0	Initial bootloader version
V2.1	<ul style="list-style-type: none"> – Updated Go Command to initialize the main stack pointer – Updated Go command to return NACK when jump address is in the Option byte area or System memory area – Updated Get ID command to return the device ID on two bytes – Update the bootloader version to V2.1
V2.2	<ul style="list-style-type: none"> – Updated Read Memory, Write Memory and Go commands to deny access with a NACK response to the first 0x200 bytes of RAM memory used by the bootloader – Updated Readout Unprotect command to initialize the whole RAM content to 0x0 before ROP disable operation

13 STM32F105xx/107xx devices bootloader

13.1 Bootloader configuration

The STM32F105xx/107xx bootloader is activated by applying pattern1 (described in [Table 2: Bootloader activation patterns](#)). The following table shows the hardware resources used by this bootloader.

Table 24. STM32F105xx/107xx configuration in system memory boot mode

Bootloader	Feature/Peripheral	State	Comment
Common to all bootloaders	RCC	HSI enabled	The system clock frequency is 24 MHz using the PLL. This is used only for USARTx bootloaders and during CAN2, USB detection for CAN and DFU bootloaders (once CAN or DFU bootloader is selected, the clock source will be derived from the external crystal).
		HSE enabled	The external clock is mandatory only for DFU and CAN bootloaders and it must provide one of the following frequencies: 8 MHz, 14.7456 MHz or 25 MHz. For CAN bootloader, the PLL is used only to generate 48 MHz when 14.7456 MHz is used as HSE. For DFU bootloader, the PLL is used to generate a 48 MHz system clock from all supported external clock frequencies.
		-	The Clock Security System (CSS) interrupt is enabled for the CAN and DFU bootloaders. Any failure (or removal) of the external clock will generate system reset.
	IWDG	-	The independent watchdog (IWDG) prescaler is configured to its maximum value and is periodically refreshed to prevent watchdog reset (in case the hardware IWDG option was previously enabled by the user).
	System memory	-	18 Kbyte starting from address 0x1FFF B000 contain the bootloader firmware.
	RAM	-	4 Kbyte starting from address 0x20000000 are used by the bootloader firmware.
USART1 bootloader	USART1	Enabled	Once initialized, the USART1 configuration is: 8 bits, even parity and 1 Stop bit.
	USART1_RX pin	Input	PA10 pin: USART1 in reception mode
	USART1_TX pin	Output push-pull	PA9 pin: USART1 in transmission mode

Table 24. STM32F105xx/107xx configuration in system memory boot mode (continued)

Bootloader	Feature/Peripheral	State	Comment
USART2 bootloader	USART2	Enabled	Once initialized, the USART2 configuration is: 8 bits, even parity and 1 Stop bit. The USART2 uses its remapped pins.
	USART2_RX pin	Input	PD6 pin: USART2 receive (remapped pin)
	USART2_TX pin	Output push-pull	PD5 pin: USART2 transmit (remapped pin)
USARTx bootloaders	SysTick timer	Enabled	Used to automatically detect the serial baud rate from the host for USARTx bootloader.
CAN2 bootloader	CAN2	Enabled	Once initialized, the CAN2 configuration is: Baudrate 125 kbps, 11-bit identifier. Note: CAN1 is clocked during the CAN bootloader execution because CAN1 manages the communication between CAN2 and SRAM.
	CAN2_RX pin	Input	PB5 pin: CAN2 receives (remapped pin).
	CAN2_TX pin	Output push-pull	PB6 pin: CAN2 transmits (remapped pin).
DFU bootloader	USB	Enabled	USB OTG FS configured in Forced Device mode
	USB_VBUS pin	Input	PA9: Power supply voltage line
	USB_DM pin	Input/Output	PA11 pin: USB_DM line
	USB_DP pin		PA12 pin: USB_DP line. No external Pull-up resistor is required

The system clock is derived from the embedded internal high-speed RC for USARTx bootloader. This internal clock is used also for DFU and CAN bootloaders but only for the selection phase. An external clock (8 MHz, 14.7456 MHz or 25 MHz.) is required for DFU and CAN bootloader execution after the selection phase.

13.2 Bootloader selection

The figure below shows the bootloader selection mechanism.

Figure 15. Bootloader selection for STM32F105xx/107xx devices

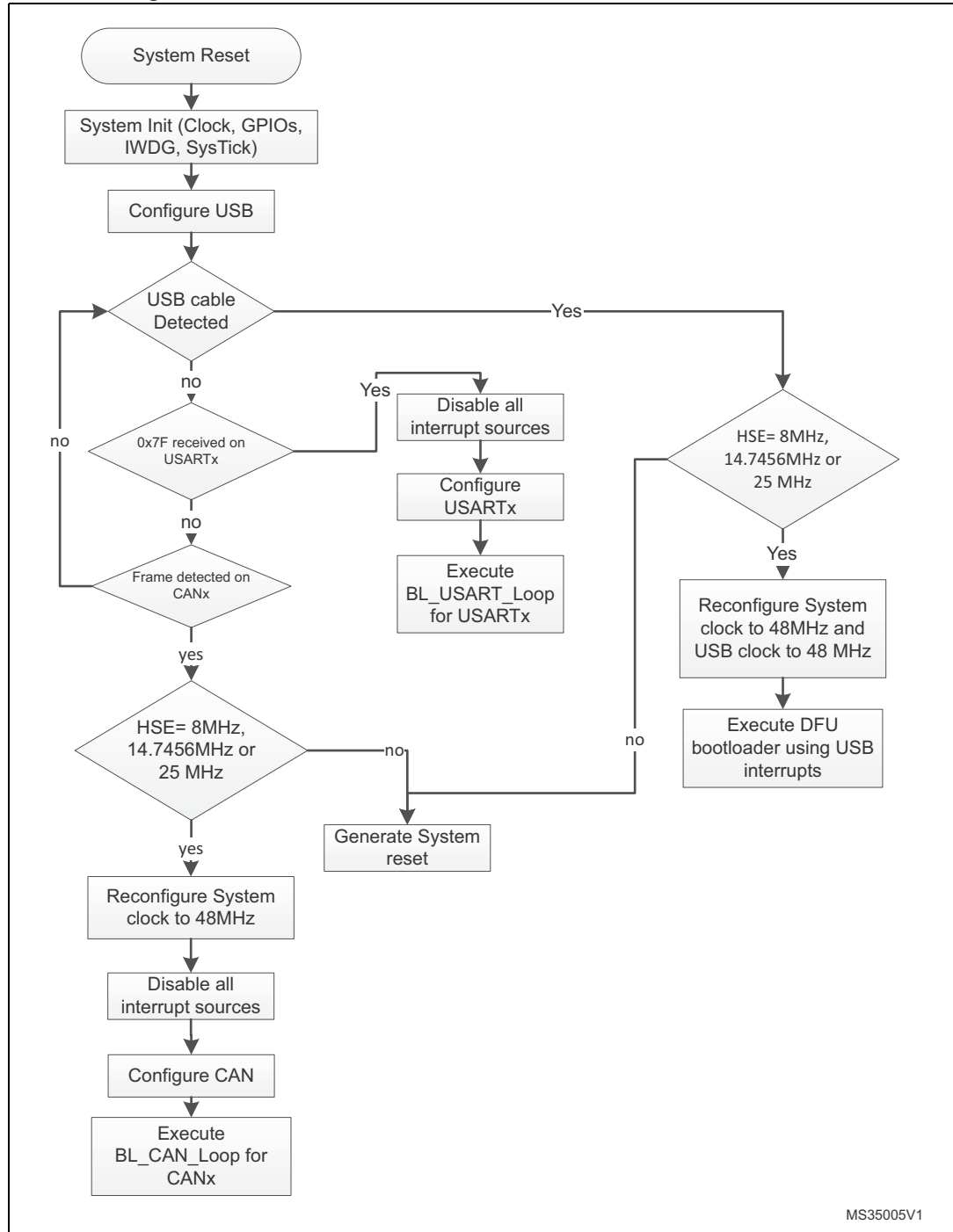

MS35005V1

13.3 Bootloader version

The following table lists the STM32F105xx/107xx devices bootloader versions:

Table 25. STM32F105xx/107xx bootloader versions

Bootloader version number	Description
V1.0	Initial bootloader version
V2.0	<ul style="list-style-type: none"> – Bootloader detection mechanism updated to fix the issue when GPIOs of unused peripherals in this bootloader are connected to low level or left floating during the detection phase. For more details please refer to Section 13.3.2. – Vector table set to 0x1FFF B000 instead of 0x0000 0000 – Go command updated (for all bootloaders): USART1, USART2, CAN2, GPIOA, GPIOB, GPIOD and SysTick peripheral registers are set to their default reset values – DFU bootloader: USB pending interrupt cleared before executing the Leave DFU command – DFU subprotocol version changed from V1.0 to V1.2 – Bootloader version updated to V2.0
V2.1	<ul style="list-style-type: none"> – Fixed PA9 excessive consumption described in Section 13.3.4. – Get-Version command (defined in AN3155) corrected. It returns 0x22 instead of 0x20 in bootloader V2.0. Refer to Section 13.3.3 for more details. – Bootloader version updated to V2.1
V2.2	<ul style="list-style-type: none"> – Fixed DFU option bytes descriptor (set to 'e' instead of 'g' because it is read/write and not erasable). – Fixed DFU polling timings for Flash Read/Write/Erase operations. – Robustness enhancements for DFU bootloader interface. – Updated bootloader version to V2.2.

13.3.1 How to identify STM32F105xx/107xx bootloader versions

Bootloader V1.0 is implemented on devices which date code is below 937 (refer to STM32F105xx and STM32F107xx datasheet for where to find the date code on the device marking). Bootloader V2.0 and V2.1 are implemented on devices with a date code higher or equal to 937.

There are two ways to distinguish between bootloader versions:

- When using the USART bootloader, the Get-Version command defined in AN2606 and AN3155 has been corrected in V2.1 version. It returns 0x22 instead of 0x20 as in bootloader V2.0.

- The values of the vector table at the beginning of the bootloader code are different. The user software (or via JTAG/SWD) reads 0x1FFFE945 at address 0x1FFFB004 for bootloader V2.0 0x1FFFE9A1 for bootloader V2.1, and 0x1FFFE9C1 for bootloader V2.2.
- The DFU version is the following:
 - V2.1 in bootloader V2.1
 - V2.2 in bootloader V2.2.It can be read through the `bcdDevice` field of the DFU Device Descriptor.

13.3.2 Bootloader unavailability on STM32F105xx/STM32F107xx devices with a date code below 937

Description

The bootloader cannot be used if the USART1_RX (PA10), USART2_RX (PD6, remapped), CAN2_Rx (PB5, remapped), OTG_FS_DM (PA11), and/or OTG_FS_DP (PA12) pin(s) are held low or left floating during the bootloader activation phase.

The bootloader cannot be connected through CAN2 (remapped), DFU (OTG FS in Device mode), USART1 or USART2 (remapped).

On 64-pin packages, the USART2_RX signal remapped PD6 pin is not available and it is internally grounded. In this case, the bootloader cannot be used at all.

Workaround

- For 64-pin packages
None. The bootloader cannot be used.
- For 100-pin packages
Depending on the used peripheral, the pins for the unused peripherals have to be kept at a high level during the bootloader activation phase as described below:
 - If USART1 is used to connect to the bootloader, PD6 and PB5 have to be kept at a high level.
 - If USART2 is used to connect to the bootloader, PA10, PB5, PA11 and PA12 have to be kept at a high level.
 - If CAN2 is used to connect to the bootloader, PA10, PD6, PA11 and PA12 have to be kept at a high level.
 - If DFU is used to connect to the bootloader, PA10, PB5 and PD6 have to be kept at a high level.

Note: This limitation applies only to STM32F105xx and STM32F107xx devices with a date code below 937. STM32F105xx and STM32F107xx devices with a date code higher or equal to 937 are not impacted. See STM32F105xx and STM32F107xx datasheets for where to find the date code on the device marking.

13.3.3 USART bootloader Get-Version command returns 0x20 instead of 0x22

Description

In USART mode, the Get-Version command (defined in AN3155) returns 0x20 instead of 0x22.

This limitation is present on bootloader versions V1.0 and V2.0, while it is fixed in bootloader version 2.1.

Workaround

None.

13.3.4 PA9 excessive power consumption when USB cable is plugged in bootloader V2.0

Description

When connecting a USB cable after booting from System-Memory mode, PA9 pin (connected to $V_{BUS}=5\text{ V}$) is also shared with USART TX pin which is configured as alternate push-pull and forced to 0 since the USART peripheral is not yet clocked. As a consequence, a current higher than 25 mA is drained by PA9 I/O and may affect the I/O pad reliability.

This limitation is fixed in bootloader version 2.1 by configuring PA9 as alternate function push-pull when a correct 0x7F is received on RX pin and the USART is clocked. Otherwise, PA9 is configured as alternate input floating.

Workaround

None.

14 STM32F10xxx XL-density devices bootloader

14.1 Bootloader configuration

The STM32F10xxx XL-density bootloader is activated by applying pattern3 (described in [Table 2: Bootloader activation patterns](#)). The following table shows the hardware resources used by this bootloader:

Table 26. STM32F10xxx XL-density configuration in system memory boot mode

Bootloader	Feature/Peripheral	State	Comment
Common to all bootloaders	RCC	HSI enabled	The system clock frequency is 24 MHz using the PLL.
	RAM	-	2 Kbyte starting from address 0x2000 0000 are used by the bootloader firmware.
	System memory	-	6 Kbyte starting from address 0x1FFF E000 contain the bootloader firmware.
	IWDG	-	The independent watchdog (IWDG) prescaler is configured to its maximum value and is periodically refreshed to prevent watchdog reset (in case the hardware IWDG option was previously enabled by the user).
USART1 bootloader	USART1	Enabled	Once initialized, the USART1 configuration is: 8 bits, even parity and 1 Stop bit.
	USART1_RX pin	Input	PA10 pin: USART1 in reception mode
	USART1_TX pin	Output push-pull	PA9 pin: USART1 in transmission mode
USART2 bootloader	USART2	Enabled	Once initialized, the USART2 configuration is: 8 bits, even parity and 1 Stop bit.
	USART2_RX pin	Input	PD6 pin: USART2 receives (remapped pins).
	USART2_TX pin	Output push-pull	PD5 pin: USART2 transmits (remapped pins).
USARTx bootloaders	SysTick timer	Enabled	Used to automatically detect the serial baud rate from the host.

The system clock is derived from the embedded internal high-speed RC, no external quartz is required for the bootloader execution.

14.2 Bootloader selection

The figure below shows the bootloader selection mechanism.

Figure 16. Bootloader selection for STM32F10xxx XL-density devices

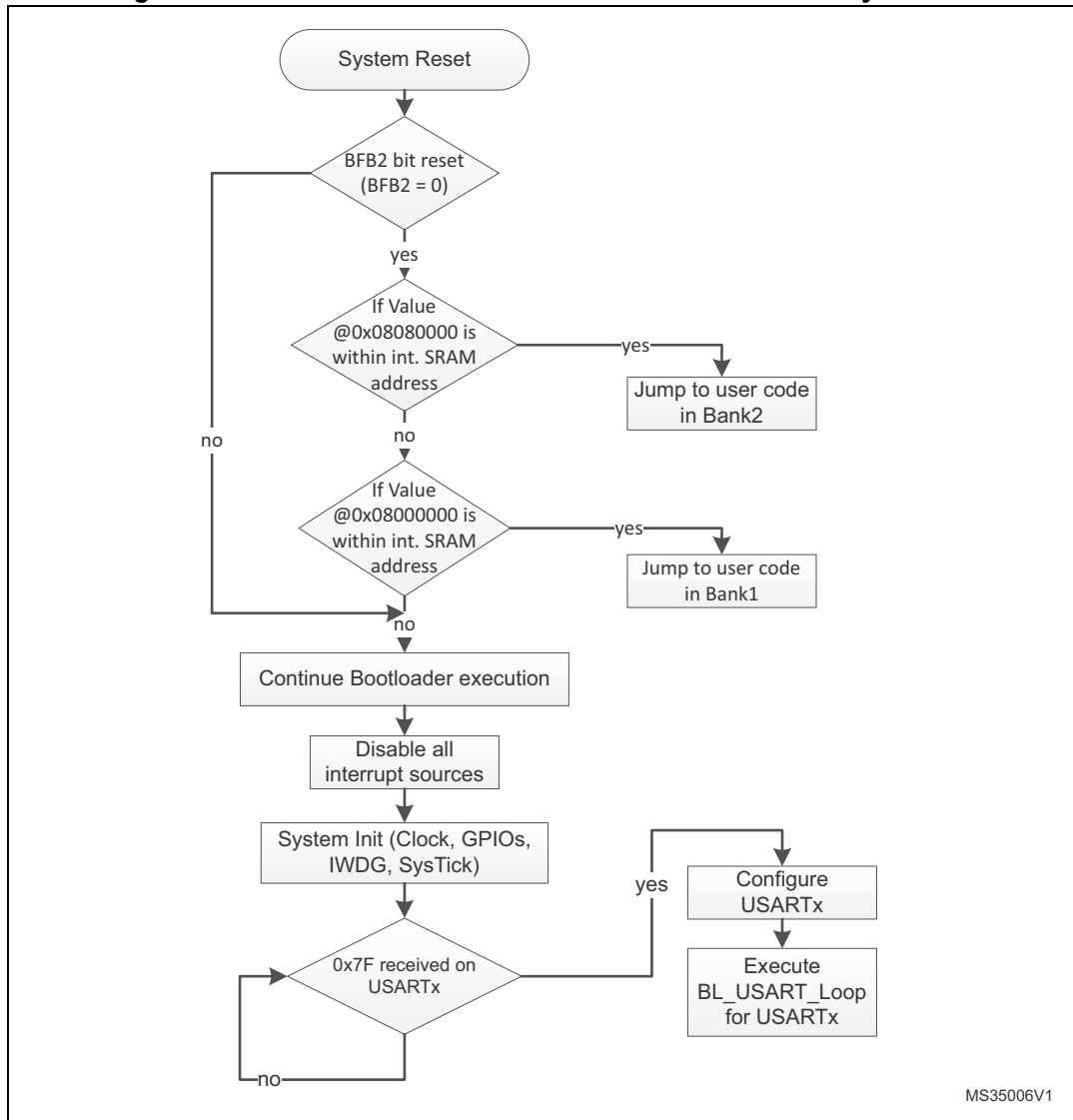

14.3 Bootloader version

The following table lists the STM32F10xxx XL-density devices bootloader versions:

Table 27. STM32F10xxx XL-density bootloader versions

Bootloader version number	Description
V2.1	Initial bootloader version

15 STM32F2xxxx devices bootloader

Two bootloader versions are available on STM32F2xxxx devices:

- V2.x supporting USART1 and USART3
This version is embedded in STM32F2xxxx devices revision B.
- V3.x supporting USART1, USART3, CAN2 and DFU (USB FS Device)
This version is embedded in STM32F2xxxx devices revision X and Y.

15.1 Bootloader V2.x

15.1.1 Bootloader configuration

The STM32F2xxxx bootloader is activated by applying pattern1 (described in [Table 2: Bootloader activation patterns](#)). The following table shows the hardware resources used by this bootloader.

Table 28. STM32F2xxxx configuration in system memory boot mode

Bootloader	Feature/Peripheral	State	Comment
Common to all bootloaders	RCC	HSI enabled	The system clock frequency is 24 MHz.
	RAM	-	8 Kbyte starting from address 0x2000 0000.
	System memory	-	30688 byte starting from address 0x1FFF 0000 contain the bootloader firmware.
	IWDG	-	The independent watchdog (IWDG) prescaler is configured to its maximum value and is periodically refreshed to prevent watchdog reset (in case the hardware IWDG option was previously enabled by the user).
	Power	-	Voltage range is set to [1.62 V, 2.1 V]. In this range internal Flash write operations are allowed only in byte format (Half-Word, Word and Double-Word operations are not allowed). The voltage range can be configured in run time using bootloader commands.
USART1 bootloader	USART1	Enabled	Once initialized, the USART1 configuration is: 8 bits, even parity and 1 Stop bit.
	USART1_RX pin	Input	PA10 pin: USART1 in reception mode
	USART1_TX pin	Output	PA9 pin: USART1 in transmission mode
USART3 bootloader (on PC10/PC11)	USART3	Enabled	Once initialized, the USART3 configuration is: 8 bits, even parity and 1 Stop bit.
	USART3_RX pin	Input	PC11 pin: USART3 in reception mode
	USART3_TX pin	Output	PC10 pin: USART3 in transmission mode

Table 28. STM32F2xxxx configuration in system memory boot mode (continued)

Bootloader	Feature/Peripheral	State	Comment
USART3 bootloader (on PB10/PB11)	USART3	Enabled	Once initialized, the USART3 configuration is: 8 bits, even parity and 1 Stop bit
	USART3_RX pin	Input	PB11 pin: USART3 in reception mode
	USART3_TX pin	Output	PB10 pin: USART3 in transmission mode
USARTx bootloaders	SysTick timer	Enabled	Used to automatically detect the serial baud rate from the host.

The system clock is derived from the embedded internal high-speed RC. No external quartz is required for the bootloader code.

15.1.2 Bootloader selection

The figure below shows the bootloader selection mechanism.

Figure 17. Bootloader V2.x selection for STM32F2xxxx devices

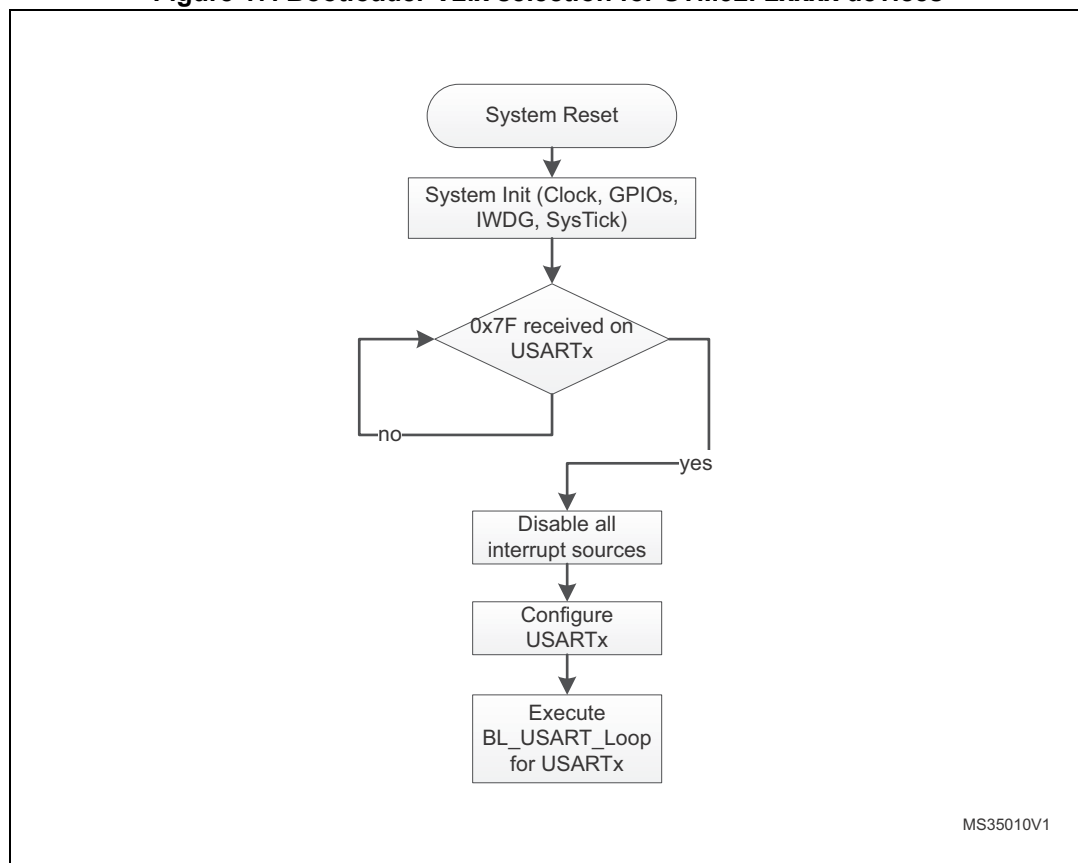

15.1.3 Bootloader version

This following table lists the STM32F2xxxx devices V2.x bootloader versions:

Table 29. STM32F2xxxx bootloader V2.x versions

Bootloader version number	Description	Known limitations
V2.0	Initial V2.x bootloader version	When a Read Memory command or Write Memory command is issued with an unsupported memory address and a correct address checksum (ie. address 0x6000 0000), the command is aborted by the bootloader device, but the NACK (0x1F) is not sent to the host. As a result, the next 2 bytes (which are the number of bytes to be read/written and its checksum) are considered as a new command and its checksum. For the CAN interface, the Write Unprotect command is not functional. Instead you can use Write Memory command and write directly to the option bytes in order to disable the write protection. ⁽¹⁾

1. If the “number of data - 1” (N-1) to be read/written is not equal to a valid command code (0x00, 0x01, 0x02, 0x11, 0x21, 0x31, 0x43, 0x44, 0x63, 0x73, 0x82 or 0x92), then the limitation is not perceived from the host since the command is NACKed anyway (as an unsupported new command).

15.2 Bootloader V3.x

15.2.1 Bootloader configuration

The STM32F2xxxx bootloader is activated by applying pattern1 (described in [Table 2: Bootloader activation patterns](#)). The following table shows the hardware resources used by this bootloader.

Table 30. STM32F2xxxx configuration in system memory boot mode

Bootloader	Feature/Peripheral	State	Comment
Common to all bootloaders	RCC	HSI enabled	The system clock frequency is 24 MHz using the PLL. The HSI clock source is used at startup (interface detection phase) and when USARTx interfaces are selected (once CAN or DFU bootloader is selected, the clock source will be derived from the external crystal).
		HSE enabled	The system clock frequency is 60 MHz. The HSE clock source is used only when the CAN or the DFU (USB FS Device) interfaces are selected. The external clock must provide a frequency multiple of 1 MHz and ranging from 4 MHz to 26 MHz.
		-	The Clock Security System (CSS) interrupt is enabled for the CAN and DFU bootloaders. Any failure (or removal) of the external clock generates system reset.
	RAM	-	8 Kbyte starting from address 0x20000000 are used by the bootloader firmware.
	System memory	-	30688 byte starting from address 0x1FF0 0000 contain the bootloader firmware.
	IWDG	-	The independent watchdog (IWDG) prescaler is configured to its maximum value. It is periodically refreshed to prevent watchdog reset (in case the hardware IWDG option was previously enabled by the user).
	Power	-	Voltage range is set to [1.62 V, 2.1 V]. In this range internal Flash write operations are allowed only in byte format (Half-Word, Word and Double-Word operations are not allowed). The voltage range can be configured in run time using bootloader commands.

Table 30. STM32F2xxxx configuration in system memory boot mode (continued)

Bootloader	Feature/Peripheral	State	Comment
USART1 bootloader	USART1	Enabled	Once initialized, the USART1 configuration is: 8 bits, even parity and 1 Stop bit.
	USART1_RX pin	Input	PA10 pin: USART1 in reception mode
	USART1_TX pin	Output	PA9 pin: USART1 in transmission mode
USART3 bootloader (on PB10/PB11)	USART3	Enabled	Once initialized, the USART3 configuration is: 8 bits, even parity and 1 Stop bit.
	USART3_RX pin	Input	PB11 pin: USART3 in reception mode
	USART3_TX pin	Output	PB10 pin: USART3 in transmission mode
USART3 bootloader (on PC10/PC11)	USART3	Enabled	Once initialized, the USART3 configuration is: 8 bits, even parity and 1 Stop bit.
	USART3_RX pin	Input	PC11 pin: USART3 in reception mode
	USART3_TX pin	Output	PC10 pin: USART3 in transmission mode
USARTx bootloaders	SysTick timer	Enabled	Used to automatically detect the serial baud rate from the host for USARTx bootloaders.
CAN2 bootloader	CAN2	Enabled	Once initialized, the CAN2 configuration is: Baudrate 125 kbps, 11-bit identifier. Note: CAN1 is clocked during CAN2 bootloader execution because CAN1 manages the communication between CAN2 and SRAM.
	CAN2_RX pin	Input	PB5 pin: CAN2 in reception mode
	CAN2_TX pin	Output	PB13 pin: CAN2 in transmission mode
DFU bootloader	USB	Enabled	USB OTG FS configured in Forced Device mode
	USB_DM pin	Input/Output	PA11: USB DM line.
	USB_DP pin		PA12: USB DP line No external Pull-up resistor is required
CAN2 and DFU bootloaders	TIM11	Enabled	This timer is used to determine the value of the HSE. Once the HSE frequency is determined, the system clock is configured to 60 MHz using PLL and HSE.

The system clock is derived from the embedded internal high-speed RC for USARTx bootloaders. This internal clock is also used for CAN and DFU (USB FS Device) but only for the selection phase. An external clock multiple of 1 MHz (between 4 and 26 MHz) is required for CAN and DFU bootloader execution after the selection phase.

15.2.2 Bootloader selection

The figure below shows the bootloader selection mechanism.

Figure 18. Bootloader V3.x selection for STM32F2xxxx devices

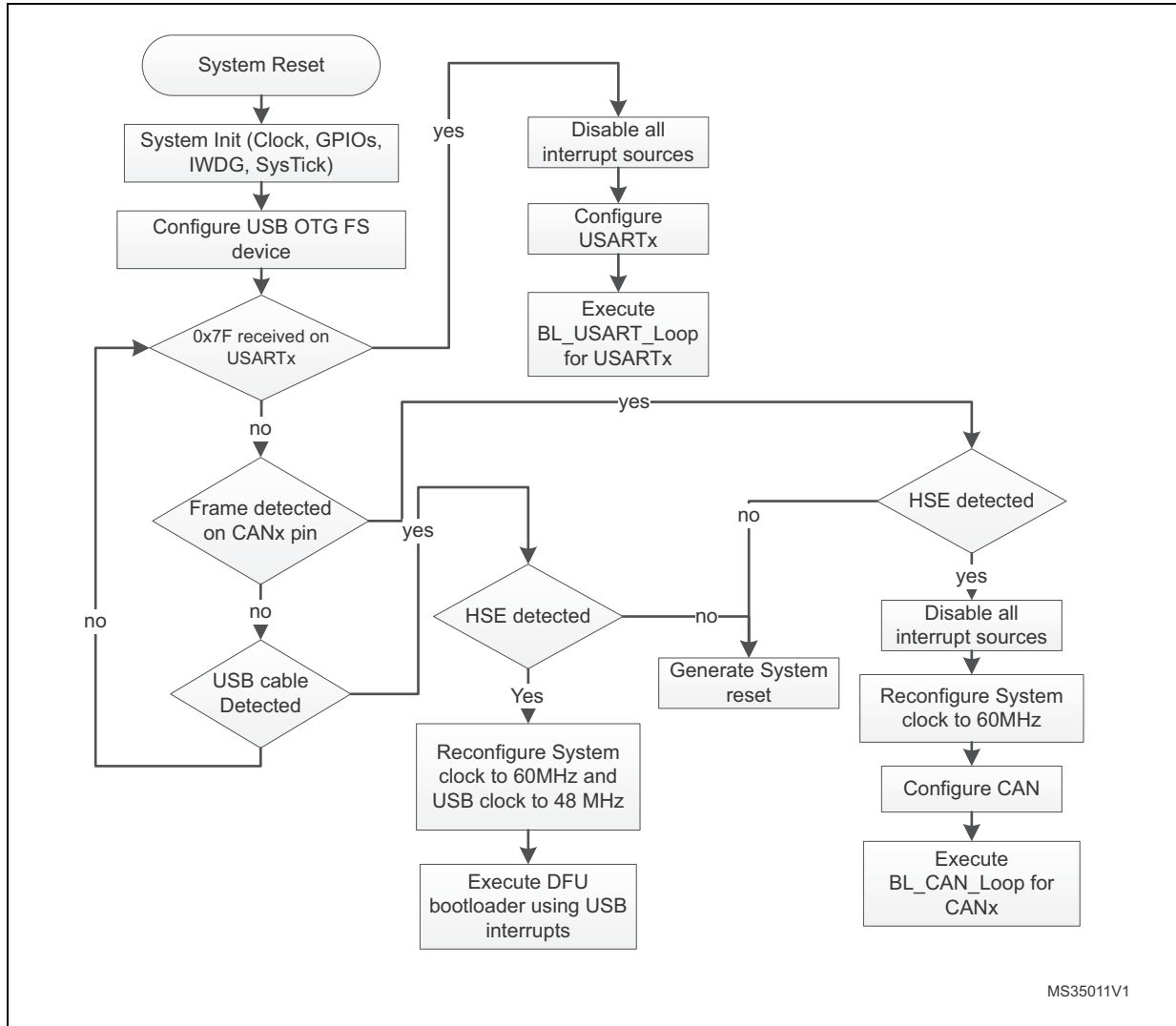

MS35011V1

15.2.3 Bootloader version

The following table lists the STM32F2xxxx devices V3.x bootloader versions:

Table 31. STM32F2xxxx bootloader V3.x versions

Bootloader version number	Description	Known limitations
V3.2	Initial V3.x bootloader version.	<ul style="list-style-type: none"> – When a Read Memory command or Write Memory command is issued with an unsupported memory address and a correct address checksum (ie. address 0x6000 0000), the command is aborted by the bootloader device, but the NACK (0x1F) is not sent to the host. As a result, the next 2 bytes (which are the number of bytes to be read/written and its checksum) are considered as a new command and its checksum⁽¹⁾. – Option bytes, OTP and Device Feature descriptors (in DFU interface) are set to “g” instead of “e” (not erasable memory areas).
V3.3	Fix V3.2 limitations. DFU interface robustness enhancement.	<ul style="list-style-type: none"> – For the USART interface, two consecutive NACKs (instead of 1 NACK) are sent when a Read Memory or Write Memory command is sent and the RDP level is active. – For the CAN interface, the Write Unprotect command is not functional. Instead you can use Write Memory command and write directly to the option bytes in order to disable the write protection.

1. If the “number of data - 1” (N-1) to be read/written is not equal to a valid command code (0x00, 0x01, 0x02, 0x11, 0x21, 0x31, 0x43, 0x44, 0x63, 0x73, 0x82 or 0x92), then the limitation is not perceived from the host since the command is NACKed anyway (as an unsupported new command).

16 STM32F301xx/302x4(6/8) devices bootloader

16.1 Bootloader configuration

The STM32F301xx/302x4(6/8) bootloader is activated by applying pattern2 (described in [Table 2: Bootloader activation patterns](#)). The following table shows the hardware resources used by this bootloader.

Table 32. STM32F301xx/302x4(6/8) configuration in system memory boot mode

Bootloader	Feature/Peripheral	State	Comment
Common to all bootloaders	RCC	HSI enabled	The system clock frequency is 48 MHz with HSI 48 MHz as clock source.
		HSE enabled	The external clock can be used for all bootloader interfaces and should have one the following values [24, 18, 16, 12, 9, 8, 6, 4, 3] MHz. The PLL is used to generate the USB48 MHz clock and the 48 MHz clock for the system clock.
		-	The Clock Security System (CSS) interrupt is enabled for the DFU bootloader. Any failure (or removal) of the external clock generates system reset.
	RAM	-	6 Kbyte starting from address 0x20000000 are used by the bootloader firmware
	System memory	-	8 Kbyte starting from address 0x1FFFD800, contain the bootloader firmware
	IWDG	-	The independent watchdog (IWDG) prescaler is configured to its maximum value. It is periodically refreshed to prevent watchdog reset (in case the hardware IWDG option was previously enabled by the user).
USART1 bootloader	USART1	Enabled	Once initialized the USART1 configuration is: 8-bits, even parity and 1 Stop bit
	USART1_RX pin	Input	PA10 pin: USART1 in reception mode
	USART1_TX pin	Output	PA9 pin: USART1 in transmission mode
USART2 bootloader	USART2	Enabled	Once initialized the USART2 configuration is: 8-bits, even parity and 1 Stop bit
	USART2_RX pin	Input	PA3 pin: USART2 in reception mode
	USART2_TX pin	Output	PA2 pin: USART2 in transmission mode
USARTx bootloaders	SysTick timer	Enabled	Used to automatically detect the serial baud rate from the host for USARTx bootloaders.

Table 32. STM32F301xx/302x4(6/8) configuration in system memory boot mode (continued)

Bootloader	Feature/Peripheral	State	Comment
DFU bootloader	USB	Enabled	USB used in FS mode
	USB_DM pin	Input/Output	PA11: USB DM line.
	USB_DP pin		PA12: USB DP line An external pull-up resistor 1.5 KOhm must be connected to USB_DP pin.

The bootloader has two case of operation depending on the presence of the external clock (HSE) at bootloader startup:

- If HSE is present and has a value of 24, 18, 16, 12, 9, 8, 6, 4 or 3 MHz, the system clock is configured to 48 MHz with HSE as clock source. The DFU interface, USART1 and USART2 are functional and can be used to communicate with the bootloader device.
- If HSE is not present, the HSI is kept as default clock source and only USART1 and USART2 are functional.

The external clock (HSE) must be kept if it's connected at bootloader startup because it will be used as system clock source.

16.2 Bootloader selection

The figure below shows the bootloader selection mechanism.

Figure 19. Bootloader selection for STM32F301xx/302x4(6/8)

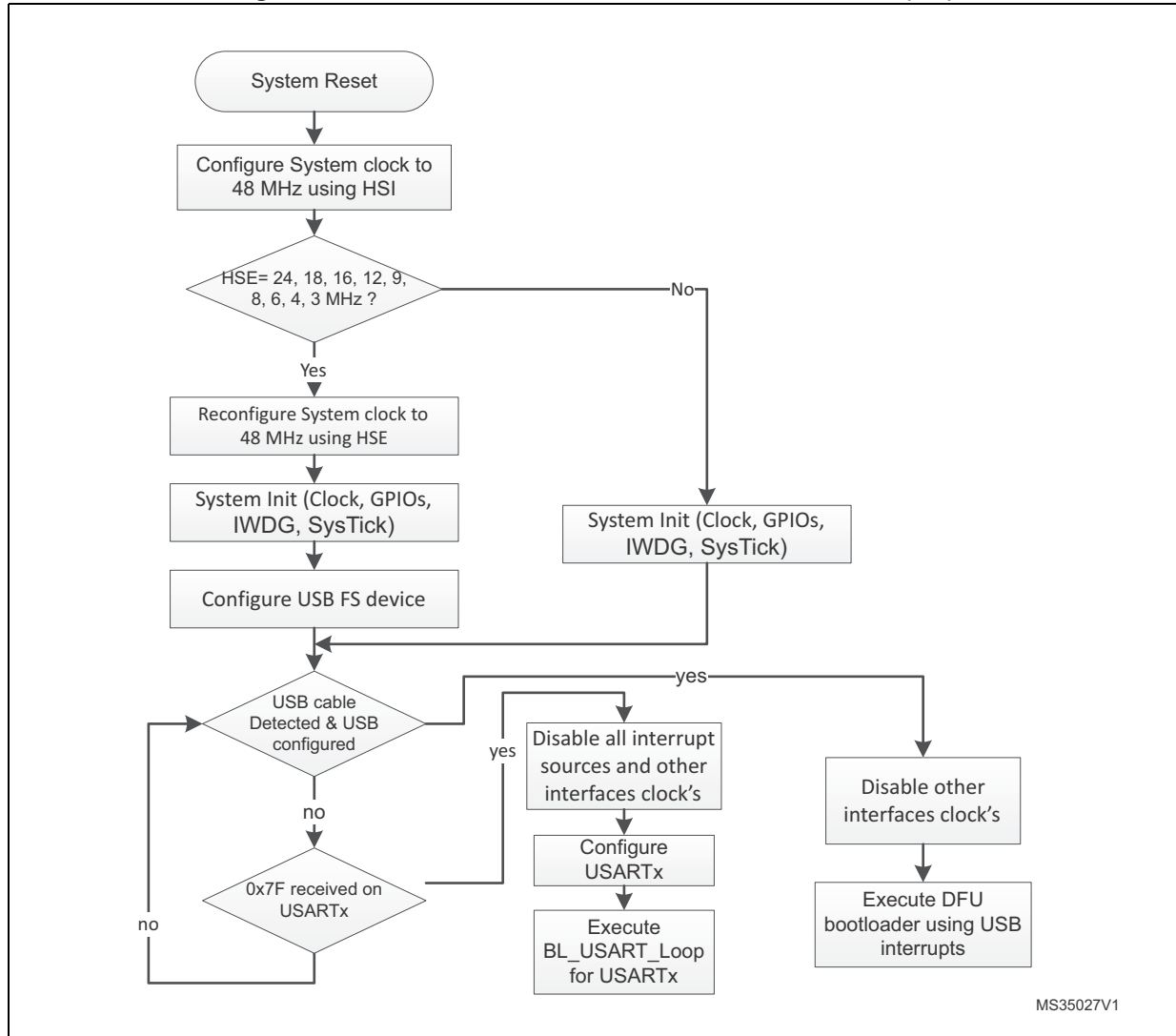

16.3 Bootloader version

The following table lists the STM32F301xx/302x4(6/8) devices bootloader versions:

Table 33. STM32F301xx/302x4(6/8) bootloader versions

Bootloader version number	Description	Known limitations
V4.0	Initial bootloader version	None

17 STM32F302xB(C)/303xB(C) devices bootloader

17.1 Bootloader configuration

The STM32F302xB(C)/303xB(C) bootloader is activated by applying pattern2 (described in [Table 2: Bootloader activation patterns](#)). The following table shows the hardware resources used by this bootloader.

Table 34. STM32F302xB(C)/303xB(C) configuration in system memory boot mode

Bootloader	Feature/Peripheral	State	Comment
Common to all bootloaders	RCC	HSI enabled	At startup, the system clock frequency is configured to 48 MHz using the HSI. If an external clock (HSE) is not present, the system is kept clocked from the HSI.
		HSE enabled	The external clock can be used for all bootloader interfaces and should have one the following values [24, 18,16, 12, 9, 8, 6, 4, 3] MHz. The PLL is used to generate the USB 48 MHz clock and the 48 MHz clock for the system clock.
		-	The Clock Security System (CSS) interrupt is enabled for the DFU bootloader. Any failure (or removal) of the external clock generates system reset.
	IWDG	-	The independent watchdog (IWDG) prescaler is configured to its maximum value and is periodically refreshed to prevent watchdog reset (in case the hardware IWDG option was previously enabled by the user).
	System memory	-	8 Kbyte starting from address 0x1FFFD800. This area contains the bootloader firmware
	RAM	-	5 Kbyte starting from address 0x20000000 are used by the bootloader firmware.
USART1 bootloader	USART1	Enabled	Once initialized, the USART1 configuration is: 8 bits, even parity and 1 Stop bit.
	USART1_RX pin	Input	PA10 pin: USART1 in reception mode
	USART1_TX pin	Output	PA9 pin: USART1 in transmission mode
USART2 bootloader	USART2	Enabled	Once initialized, the USART2 configuration is: 8 bits, even parity and 1 Stop bit. The USART2 uses its remapped pins.
	USART2_RX pin	Input	PD6 pin: USART2 in reception mode
	USART2_TX pin	Output	PD5 pin: USART2 in transmission mode
USARTx bootloaders	SysTick timer	Enabled	Used to automatically detect the serial baud rate from the host for USARTx bootloader.

Table 34. STM32F302xB(C)/303xB(C) configuration in system memory boot mode (continued)

Bootloader	Feature/Peripheral	State	Comment
DFU bootloader	USB	Enabled	USB used in FS mode
	USB_DM pin	Input/Output	PA11: USB DM line.
	USB_DP pin		PA12: USB DP line An external pull-up resistor 1.5 KOhm must be connected to USB_DP pin.

The bootloader has two case of operation depending on the presence of the external clock (HSE) at bootloader startup:

- If HSE is present and has a value of 24, 18, 16, 12, 9, 8, 6, 4 or 3 MHz, the system clock is configured to 48 MHz with HSE as clock source. The DFU interface, USART1 and USART2 are functional and can be used to communicate with the bootloader device.
- If HSE is not present, the HSI is kept as default clock source and only USART1 and USART2 are functional.

The external clock (HSE) must be kept if it's connected at bootloader startup because it will be used as system clock source.

17.2 Bootloader selection

The figure below shows the bootloader selection mechanism.

Figure 20. Bootloader selection for STM32F302xB(C)/303xB(C) devices

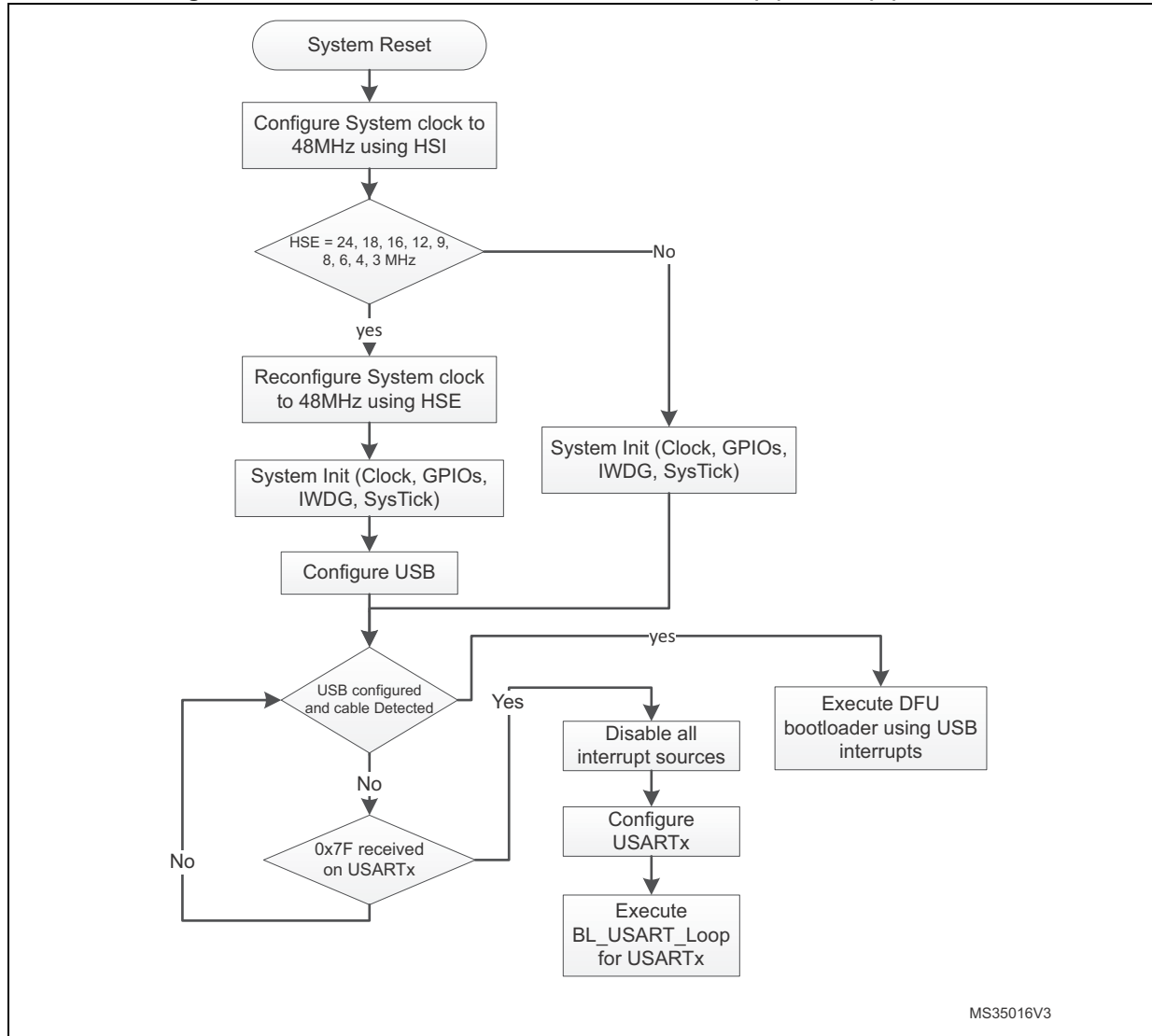

17.3 Bootloader version

The following table lists the STM32F302xB(C)/303xB(C) devices bootloader versions.

Table 35. STM32F302xB(C)/303xB(C) bootloader versions

Bootloader version number	Description	Known limitations
V4.1	Initial bootloader version	None

18 STM32F302xD(E)/303xD(E) devices bootloader

18.1 Bootloader configuration

The STM32F302xD(E)/303xD(E) bootloader is activated by applying pattern2 (described in [Table 2: Bootloader activation patterns](#)). The following table shows the hardware resources used by this bootloader.

Table 36. STM32F302xD(E)/303xD(E) configuration in system memory boot mode

Bootloader	Feature/Peripheral	State	Comment
Common to all bootloaders	RCC	HSI enabled	The system clock frequency is 48 MHz with HSI 48 MHz as clock source.
		HSE enabled	The external clock can be used for all bootloader interfaces and should have one of the following values [24, 18, 16, 12, 9, 8, 6, 4, 3] MHz. The PLL is used to generate the USB 48 MHz clock and the 48 MHz clock for the system clock.
		-	The Clock Security System (CSS) interrupt is enabled for the DFU bootloader. Any failure (or removal) of the external clock generates system reset.
	RAM	-	6 Kbyte starting from address 0x20000000 are used by the bootloader firmware
	System memory	-	8 Kbyte starting from address 0x1FFFD800, contain the bootloader firmware
	IWDG	-	The independent watchdog (IWDG) prescaler is configured to its maximum value. It is periodically refreshed to prevent watchdog reset (in case the hardware IWDG option was previously enabled by the user).
USART1 bootloader	USART1	Enabled	Once initialized the USART1 configuration is: 8-bits, even parity and 1 Stop bit
	USART1_RX pin	Input	PA10 pin: USART1 in reception mode
	USART1_TX pin	Output	PA9 pin: USART1 in transmission mode
USART2 bootloader	USART2	Enabled	Once initialized the USART2 configuration is: 8-bits, even parity and 1 Stop bit
	USART2_RX pin	Input	PA3 pin: USART2 in reception mode
	USART2_TX pin	Output	PA2 pin: USART2 in transmission mode
USARTx bootloaders	SysTick timer	Enabled	Used to automatically detect the serial baud rate from the host for USARTx bootloaders.
DFU bootloader	USB	Enabled	USB FS configured in Forced Device mode. USB FS interrupt vector is enabled and used for USB DFU communications.
	USB_DM pin	Input/Output	PA11 pin: USB FS DM line.
	USB_DP pin		PA12 pin: USB FS DP line. An external pull-up resistor 1.5 KOhm must be connected to USB_DP pin.

The bootloader has two cases of operation depending on the presence of the external clock (HSE) at bootloader startup:

- If HSE is present and has a value of 24, 18, 16, 12, 9, 8, 6, 4 or 3 MHz, the system clock is configured to 48 MHz with HSE as clock source. The DFU interface, USART1 and USART2 are functional and can be used to communicate with the bootloader device.
- If HSE is not present, the HSI is kept as default clock source and only USART1 and USART2 are functional.

The external clock (HSE) must be kept if it's connected at bootloader startup because it will be used as system clock source.

18.2 Bootloader selection

The figure below shows the bootloader selection mechanism.

Figure 21. Bootloader selection for STM32F302xD(E)/303xD(E)

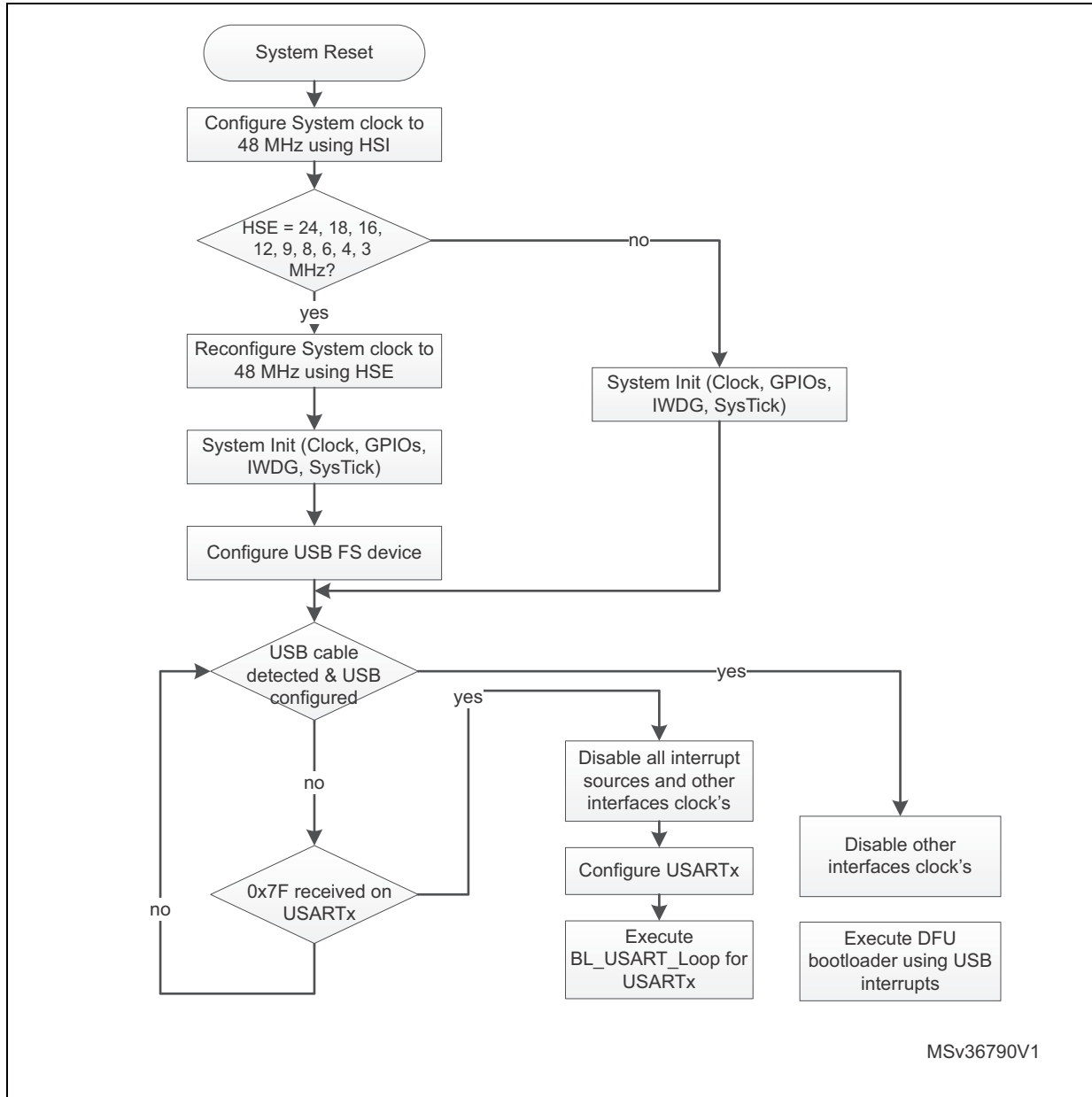

18.3 Bootloader version

The following table lists the STM32F302xD(E)/303xD(E) devices bootloader versions.

Table 37. STM32F302xD(E)/303xD(E) bootloader versions

Bootloader version number	Description	Known limitations
V4.0	Initial bootloader version	None

19 STM32F303x4(6/8)/334xx/328xx devices bootloader

19.1 Bootloader configuration

The STM32F303x4(6/8)/334xx/328xx bootloader is activated by applying pattern2 (described in [Table 2: Bootloader activation patterns](#)). The following table shows the hardware resources used by this bootloader.

Table 38. STM32F303x4(6/8)/334xx/328xx configuration in system memory boot mode

Bootloader	Feature/Peripheral	State	Comment
Common to all bootloaders	RCC	HSI enabled	The system clock frequency is 60 MHz with HSI 8 MHz as clock source.
	RAM	-	6 Kbyte starting from address 0x20000000 are used by the bootloader firmware
	System memory	-	8 Kbyte starting from address 0x1FFFD800, contain the bootloader firmware
	IWDG	-	The independent watchdog (IWDG) prescaler is configured to its maximum value. It is periodically refreshed to prevent watchdog reset (in case the hardware IWDG option was previously enabled by the user).
USART1 bootloader	USART1	Enabled	Once initialized the USART1 configuration is: 8-bits, even parity and 1 Stop bit
	USART1_RX pin	Input	PA10 pin: USART1 in reception mode
	USART1_TX pin	Output	PA9 pin: USART1 in transmission mode
USART2 bootloader	USART2	Enabled	Once initialized the USART2 configuration is: 8-bits, even parity and 1 Stop bit
	USART2_RX pin	Input	PA3 pin: USART2 in reception mode
	USART2_TX pin	Output	PA2 pin: USART2 in transmission mode
USARTx bootloaders	SysTick timer	Enabled	Used to automatically detect the serial baud rate from the host for USARTx bootloaders.
I2C1 bootloader	I2C1	Enabled	The I2C1 configuration is: I2C speed: up to 400 KHz, 7-bit address, slave mode, analog filter ON. Slave 7-bit address: 0b0111111x (where x = 0 for write and x = 1 for read)
	I2C1_SCL pin	Input/Output	PB6 pin: clock line is used in open-drain mode.
	I2C1_SDA pin	Input/Output	PB7 pin: data line is used in open-drain mode.

The system clock is derived from the embedded internal high-speed RC, no external quartz is required for the bootloader execution.

19.2 Bootloader selection

The figure below shows the bootloader selection mechanism.

Figure 22. Bootloader selection for STM32F303x4(6/8)/334xx/328xx

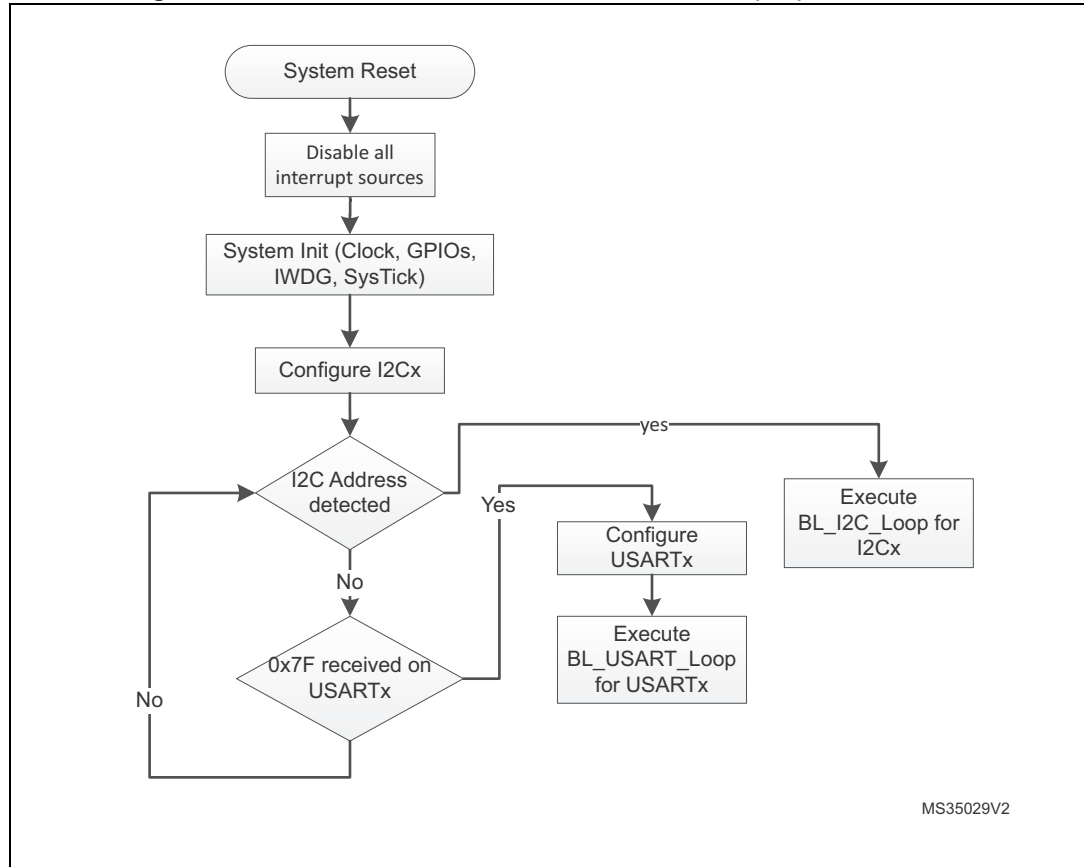

19.3 Bootloader version

The following table lists the STM32F303x4(6/8)/334xx/328xx devices bootloader versions:

Table 39. STM32F303x4(6/8)/334xx/328xx bootloader versions

Bootloader version number	Description	Known limitations
V5.0	Initial bootloader version	None

20 STM32F318xx devices bootloader

20.1 Bootloader configuration

The STM32F318xx bootloader is activated by applying pattern2 (described in [Table 2: Bootloader activation patterns](#)). The following table shows the hardware resources used by this bootloader.

Table 40. STM32F318xx configuration in system memory boot mode

Bootloader	Feature/Peripheral	State	Comment
Common to all bootloaders	RCC	HSI enabled	The system clock frequency is 60 MHz with HSI 8 MHz as clock source.
	RAM	-	6 Kbyte starting from address 0x20000000 are used by the bootloader firmware
	System memory	-	8 Kbyte starting from address 0x1FFFD800, contain the bootloader firmware
	IWDG	-	The independent watchdog (IWDG) prescaler is configured to its maximum value. It is periodically refreshed to prevent watchdog reset (in case the hardware IWDG option was previously enabled by the user).
USART1 bootloader	USART1	Enabled	Once initialized the USART1 configuration is: 8-bits, even parity and 1 Stop bit
	USART1_RX pin	Input	PA10 pin: USART1 in reception mode
	USART1_TX pin	Output	PA9 pin: USART1 in transmission mode
USART2 bootloader	USART2	Enabled	Once initialized the USART2 configuration is: 8-bits, even parity and 1 Stop bit
	USART2_RX pin	Input	PA3 pin: USART2 in reception mode
	USART2_TX pin	Output	PA2 pin: USART2 in transmission mode
USARTx bootloaders	SysTick timer	Enabled	Used to automatically detect the serial baud rate from the host for USARTx bootloaders.
I2C1 bootloader	I2C1	Enabled	The I2C1 configuration is: I2C speed: up to 400 KHz, 7-bit address, slave mode, analog filter ON. Slave 7-bit address: 0b0111101x (where x = 0 for write and x = 1 for read)
	I2C1_SCL pin	Input/Output	PB6 pin: clock line is used in open-drain mode.
	I2C1_SDA pin	Input/Output	PB7 pin: data line is used in open-drain mode.

Table 40. STM32F318xx configuration in system memory boot mode (continued)

Bootloader	Feature/Peripheral	State	Comment
I2C3 bootloader	I2C3	Enabled	The I2C3 configuration is: I2C speed: up to 400 KHz, 7-bit address, slave mode, analog filter ON. Slave 7-bit address: 0b0111101x (where x = 0 for write and x = 1 for read) and digital filter disabled.
	I2C3_SCL pin	Input/Output	PA8 pin: clock line is used in open-drain mode.
	I2C3_SDA pin	Input/Output	PB5 pin: data line is used in open-drain mode.

The system clock is derived from the embedded internal high-speed RC, no external quartz is required for the bootloader execution.

20.2 Bootloader selection

The figure below shows the bootloader selection mechanism.

Figure 23. Bootloader selection for STM32F318xx

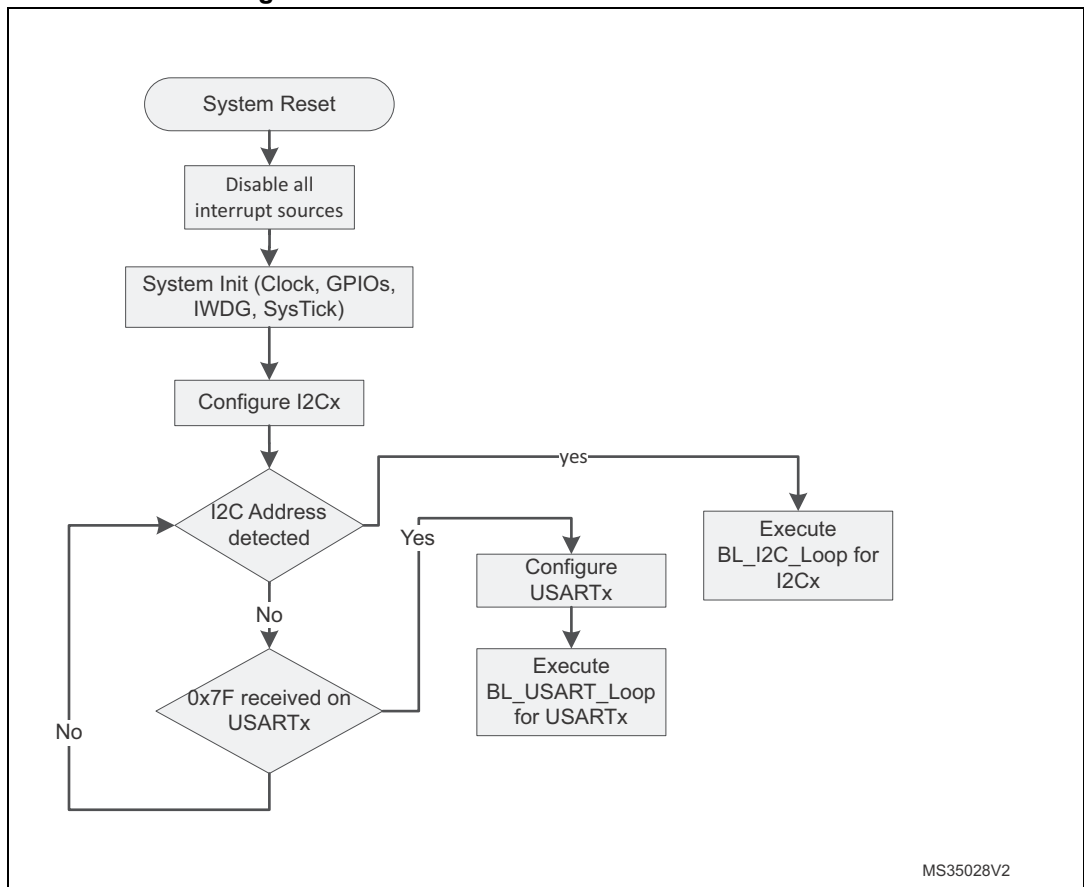

20.3 Bootloader version

The following table lists the STM32F318xx devices bootloader versions:

Table 41. STM32F318xx bootloader versions

Bootloader version number	Description	Known limitations
V5.0	Initial bootloader version	None

21 STM32F358xx devices bootloader

21.1 Bootloader configuration

The STM32F358xx bootloader is activated by applying pattern2 (described in [Table 2: Bootloader activation patterns](#)). The following table shows the hardware resources used by this bootloader.

Table 42. STM32F358xx configuration in system memory boot mode

Bootloader	Feature/Peripheral	State	Comment
Common to all bootloaders	RCC	HSI enabled	The system clock frequency is 8 MHz using the HSI.
	IWDG	-	The independent watchdog (IWDG) prescaler is configured to its maximum value and is periodically refreshed to prevent watchdog reset (in case the hardware IWDG option was previously enabled by the user). Window feature is disabled.
	System memory	-	8 Kbyte starting from address 0x1FFFD800. This area contains the bootloader firmware.
	RAM	-	5 Kbyte starting from address 0x20000000 are used by the bootloader firmware.
USART1 bootloader	USART1	Enabled	Once initialized, the USART1 configuration is: 8 bits, even parity and 1 Stop bit.
	USART1_RX pin	Input	PA10 pin: USART1 in reception mode.
	USART1_TX pin	Output	PA9 pin: USART1 in transmission mode.
USART2 bootloader	USART2	Enabled	Once initialized, the USART2 configuration is: 8 bits, even parity and 1 Stop bit. The USART2 uses its remapped pins.
	USART2_RX pin	Input	PD6 pin: USART2 in reception mode.
	USART2_TX pin	Output	PD5 pin: USART2 in transmission mode.
USARTx bootloaders	SysTick timer	Enabled	Used to automatically detect the serial baud rate from the host for USARTx bootloader.
I2C1 bootloader	I2C1	Enabled	The I2C1 configuration is: I2C speed: up to 400 KHz, 7-bit address, slave mode, analog filter ON. Slave 7-bit address: 0b0110111x (where x = 0 for write and x = 1 for read)
	I2C1_SCL pin	Input/ Output	PB6 pin: clock line is used in open-drain mode.
	I2C1_SDA pin	Input/ Output	PB7 pin: data line is used in open-drain mode.

The system clock is derived from the embedded internal high-speed RC, no external quartz is required for the bootloader execution.

21.2 Bootloader selection

The figure below shows the bootloader selection mechanism.

Figure 24. Bootloader selection for STM32F358xx devices

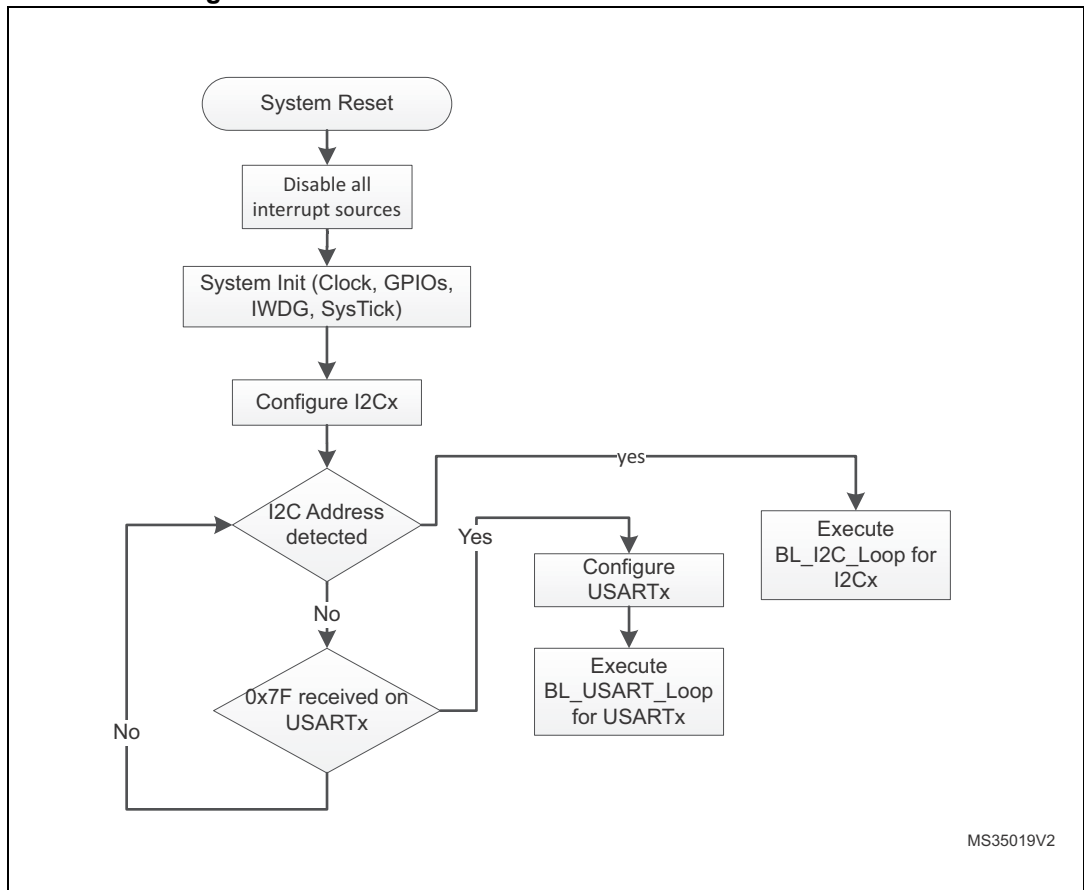

MS35019V2

21.3 Bootloader version

The following table lists the STM32F358xx devices bootloader versions.

Table 43. STM32F358xx bootloader versions

Bootloader version number	Description	Known limitations
V5.0	Initial bootloader version	For USART1 and USART2 interfaces, the maximum baudrate supported by the bootloader is 57600 baud.

22 STM32F373xx devices bootloader

22.1 Bootloader configuration

The STM32F373xx bootloader is activated by applying pattern2 (described in [Table 2: Bootloader activation patterns](#)). The following table shows the hardware resources used by this bootloader.

Table 44. STM32F373xx configuration in system memory boot mode

Bootloader	Feature/Peripheral	State	Comment
Common to all bootloaders	RCC	HSI enabled	At startup, the system clock frequency is configured to 48 MHz using the HSI. If an external clock (HSE) is not present, the system is kept clocked from the HSI.
		HSE enabled	The external clock can be used for all bootloader interfaces and should have one the following values [24, 18, 16, 12, 9, 8, 6, 4, 3] MHz. The PLL is used to generate the USB 48 MHz clock and the 48 MHz clock for the system clock.
		-	The Clock Security System (CSS) interrupt is enabled for the DFU bootloader. Any failure (or removal) of the external clock generates system reset.
	IWDG	-	The independent watchdog (IWDG) prescaler is configured to its maximum value and is periodically refreshed to prevent watchdog reset (in case the hardware IWDG option was previously enabled by the user).
	System memory	-	8 Kbyte starting from address 0x1FFFD800. This area contains the bootloader firmware
	RAM	-	5 Kbyte starting from address 0x20000000 are used by the bootloader firmware.
USART1 bootloader	USART1	Enabled	Once initialized, the USART1 configuration is: 8 bits, even parity and 1 Stop bit.
	USART1_RX pin	Input	PA10 pin: USART1 in reception mode
	USART1_TX pin	Output	PA9 pin: USART1 in transmission mode
USART2 bootloader	USART2	Enabled	Once initialized, the USART2 configuration is: 8 bits, even parity and 1 Stop bit. The USART2 uses its remapped pins.
	USART2_RX pin	Input	PD6 pin: USART2 in reception mode
	USART2_TX pin	Output	PD5 pin: USART2 in transmission mode
USARTx bootloaders	SysTick timer	Enabled	Used to automatically detect the serial baud rate from the host for USARTx bootloader.

Table 44. STM32F373xx configuration in system memory boot mode (continued)

Bootloader	Feature/Peripheral	State	Comment
DFU bootloader	USB	Enabled	USB used in FS mode
	USB_DM pin	Input/Output	PA11: USB DM line.
	USB_DP pin		PA12: USB DP line An external pull-up resistor 1.5 KOhm must be connected to USB_DP pin.

The bootloader has two case of operation depending on the presence of the external clock (HSE) at bootloader startup:

- If HSE is present and has a value of 24, 18, 16, 12, 9, 8, 6, 4 or 3 MHz, the system clock is configured to 48 MHz with HSE as clock source. The DFU interface, USART1 and USART2 are functional and can be used to communicate with the bootloader device.
- If HSE is not present, the HSI is kept as default clock source and only USART1 and USART2 are functional.

Note: The external clock (HSE) must be kept if it's connected at bootloader startup because it will be used as system clock source.

22.2 Bootloader selection

The figure below shows the bootloader selection mechanism.

Figure 25. Bootloader selection for STM32F373xx devices

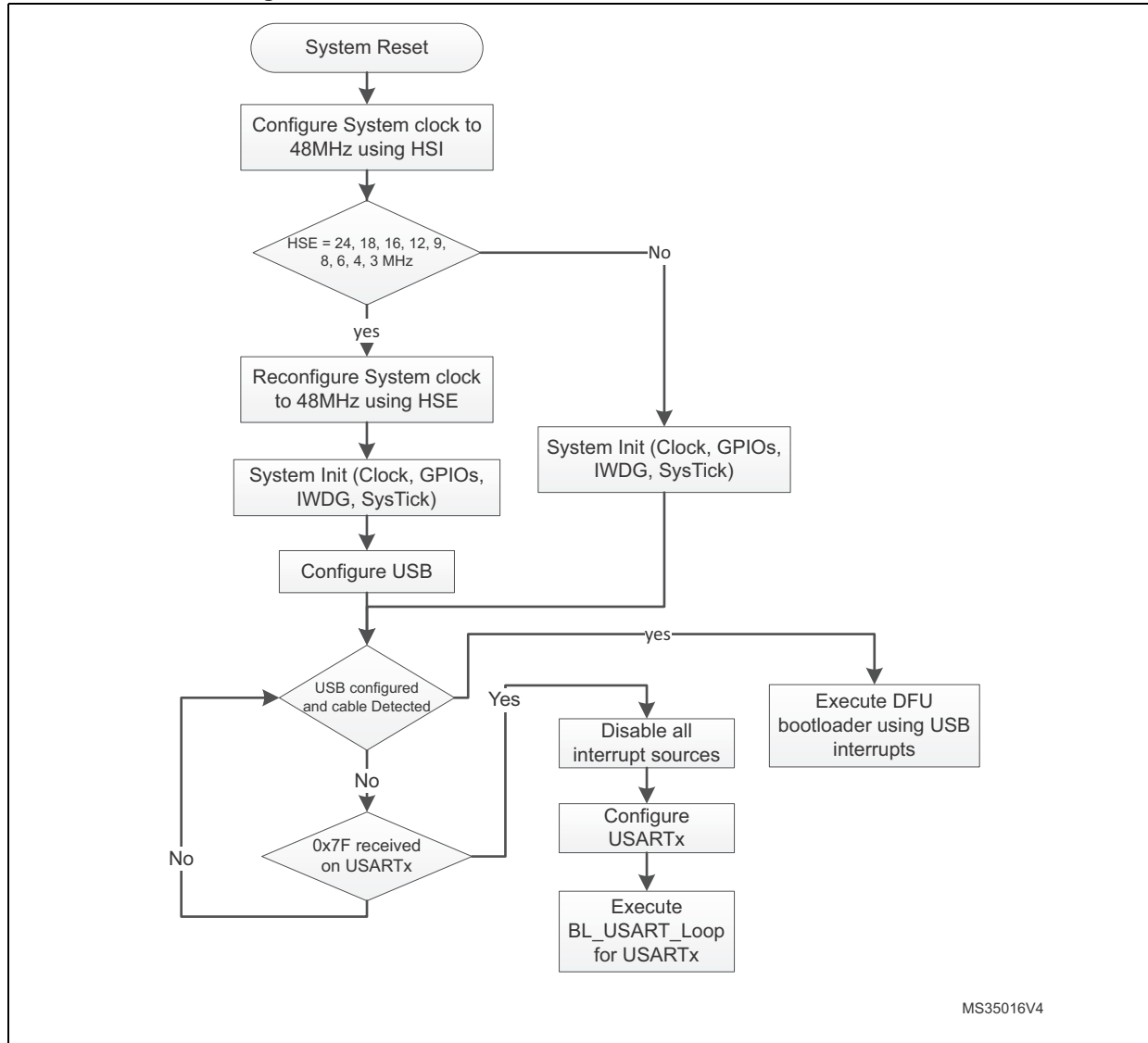

MS35016V4

22.3 Bootloader version

The following table lists the STM32F373xx devices bootloader versions.

Table 45. STM32F373xx bootloader versions

Bootloader version number	Description	Known limitations
V4.1	Initial bootloader version	None

23 STM32F378xx devices bootloader

23.1 Bootloader configuration

The STM32F378xx bootloader is activated by applying pattern2 (described in [Table 2: Bootloader activation patterns](#)). The following table shows the hardware resources used by this bootloader.

Table 46. STM32F378xx configuration in system memory boot mode

Bootloader	Feature/Peripheral	State	Comment
Common to all bootloaders	RCC	HSI enabled	The system clock frequency is 8 MHz using the HSI.
	IWDG	-	The independent watchdog (IWDG) prescaler is configured to its maximum value and is periodically refreshed to prevent watchdog reset (in case the hardware IWDG option was previously enabled by the user). Window feature is disabled.
	System memory	-	8 Kbyte starting from address 0x1FFFD800. This area contains the bootloader firmware
	RAM	-	4 Kbyte starting from address 0x20000000 are used by the bootloader firmware.
USART1 bootloader	USART1	Enabled	Once initialized, the USART1 configuration is: 8 bits, even parity and 1 Stop bit
	USART1_RX pin	Input	PA10 pin: USART1 in reception mode.
	USART1_TX pin	Output	PA9 pin: USART1 in transmission mode.
USART2 bootloader	USART2	Enabled	Once initialized, the USART2 configuration is: 8 bits, even parity and 1 Stop bit. The USART2 uses its remapped pins.
	USART2_RX pin	Input	PD6 pin: USART2 in reception mode.
	USART2_TX pin	Output	PD5 pin: USART2 in transmission mode.
USARTx bootloaders	SysTick timer	Enabled	Used to automatically detect the serial baud rate from the host for USARTx bootloader.
I2C1 bootloader	I2C1	Enabled	The I2C1 configuration is: I2C speed: up to 400 KHz, 7-bit address, slave mode, analog filter ON. Slave 7-bit address: 0b0110111x (where x = 0 for write and x = 1 for read).
	I2C1_SCL pin	Input/ Output	PB6 pin: clock line is used in open-drain mode.
	I2C1_SDA pin	Input/ Output	PB7 pin: data line is used in open-drain mode.

The system clock is derived from the embedded internal high-speed RC, no external quartz is required for the bootloader execution.

23.2 Bootloader selection

The figure below shows the bootloader selection mechanism.

Figure 26. Bootloader selection for STM32F378xx devices

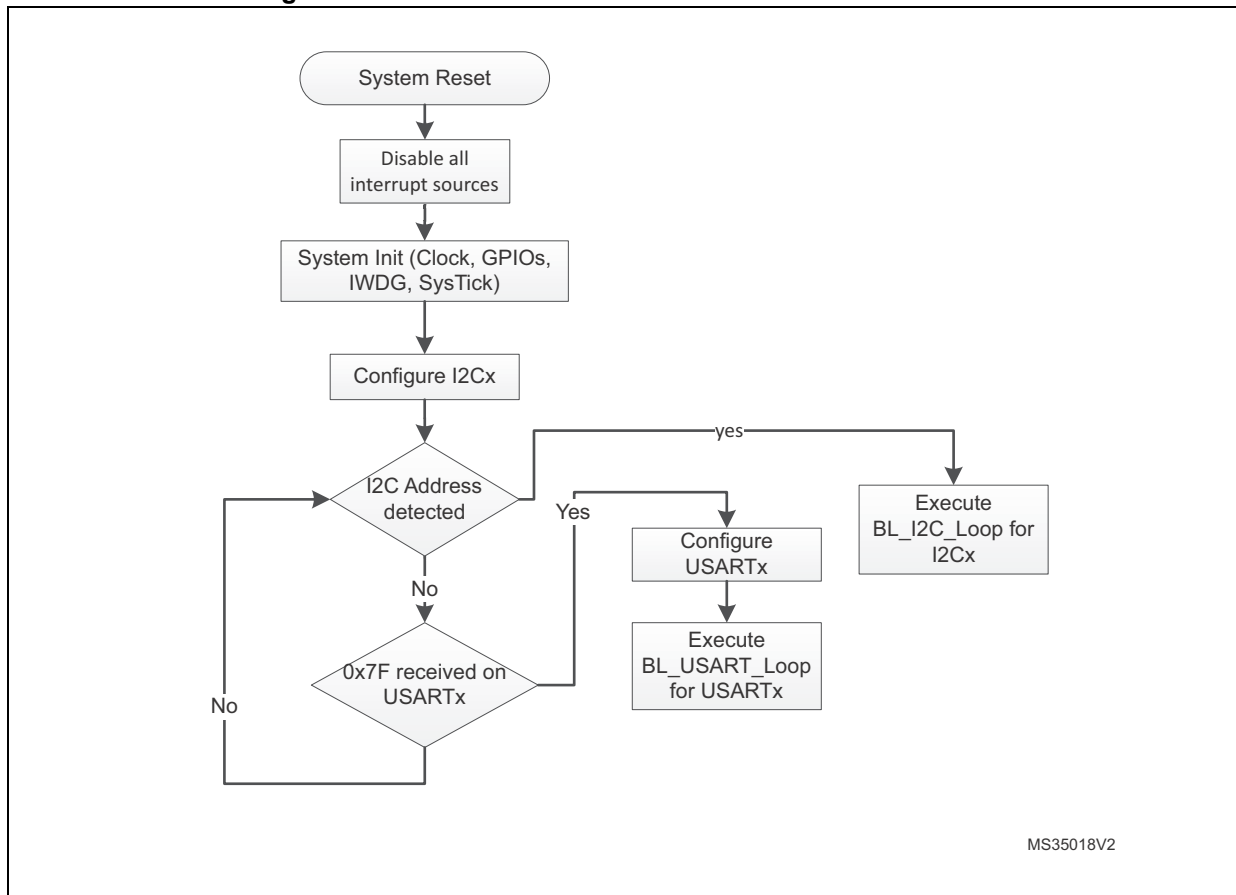

23.3 Bootloader version

The following table lists the STM32F378xx devices bootloader versions.

Table 47. STM32F378xx bootloader versions

Bootloader version number	Description	Known limitations
V5.0	Initial bootloader version	For USART1 and USART2 interfaces, the maximum baudrate supported by the bootloader is 57600 baud.

24 STM32F398xx devices bootloader

24.1 Bootloader configuration

The STM32F398xx bootloader is activated by applying pattern2 (described in [Table 2: Bootloader activation patterns](#)). The following table shows the hardware resources used by this bootloader.

Table 48. STM32F398xx configuration in system memory boot mode

Bootloader	Feature/Peripheral	State	Comment
Common to all bootloaders	RCC	HSI enabled	The system clock frequency is 60 MHz with HSI 8 MHz as clock source.
	RAM	-	6 Kbyte starting from address 0x20000000 are used by the bootloader firmware
	System memory	-	7 Kbyte starting from address 0x1FFFD800, contain the bootloader firmware
	IWDG	-	The independent watchdog (IWDG) prescaler is configured to its maximum value. It is periodically refreshed to prevent watchdog reset (in case the hardware IWDG option was previously enabled by the user).
USART1 bootloader	USART1	Enabled	Once initialized the USART1 configuration is: 8-bits, even parity and 1 Stop bit
	USART1_RX pin	Input	PA10 pin: USART1 in reception mode
	USART1_TX pin	Output	PA9 pin: USART1 in transmission mode
USART2 bootloader	USART2	Enabled	Once initialized the USART2 configuration is: 8-bits, even parity and 1 Stop bit
	USART2_RX pin	Input	PA3 pin: USART2 in reception mode
	USART2_TX pin	Output	PA2 pin: USART2 in transmission mode
USARTx bootloaders	SysTick timer	Enabled	Used to automatically detect the serial baud rate from the host for USARTx bootloaders.
I2C1 bootloader	I2C1	Enabled	The I2C1 configuration is: I2C speed: up to 400 KHz, 7-bit address, slave mode, analog filter ON. Slave 7-bit address: 0b1000000x (where x = 0 for write and x = 1 for read).
	I2C1_SCL pin	Input/Output	PB6 pin: clock line is used in open-drain mode.
	I2C1_SDA pin	Input/Output	PB7 pin: data line is used in open-drain mode.
I2C3 bootloader	I2C3	Enabled	The I2C3 configuration is: I2C speed: up to 400 KHz, 7-bit address, slave mode, analog filter ON. Slave 7-bit address: 0b1000000x (where x = 0 for write and x = 1 for read).
	I2C3_SCL pin	Input/Output	PA8 pin: clock line is used in open-drain mode.
	I2C3_SDA pin	Input/Output	PB5 pin: data line is used in open-drain mode.

The system clock is derived from the embedded internal high-speed RC for all bootloader interfaces. No external quartz is required for bootloader operations.

24.2 Bootloader selection

The figure below shows the bootloader selection mechanism.

Figure 27.Bootloader selection for STM32F398xx

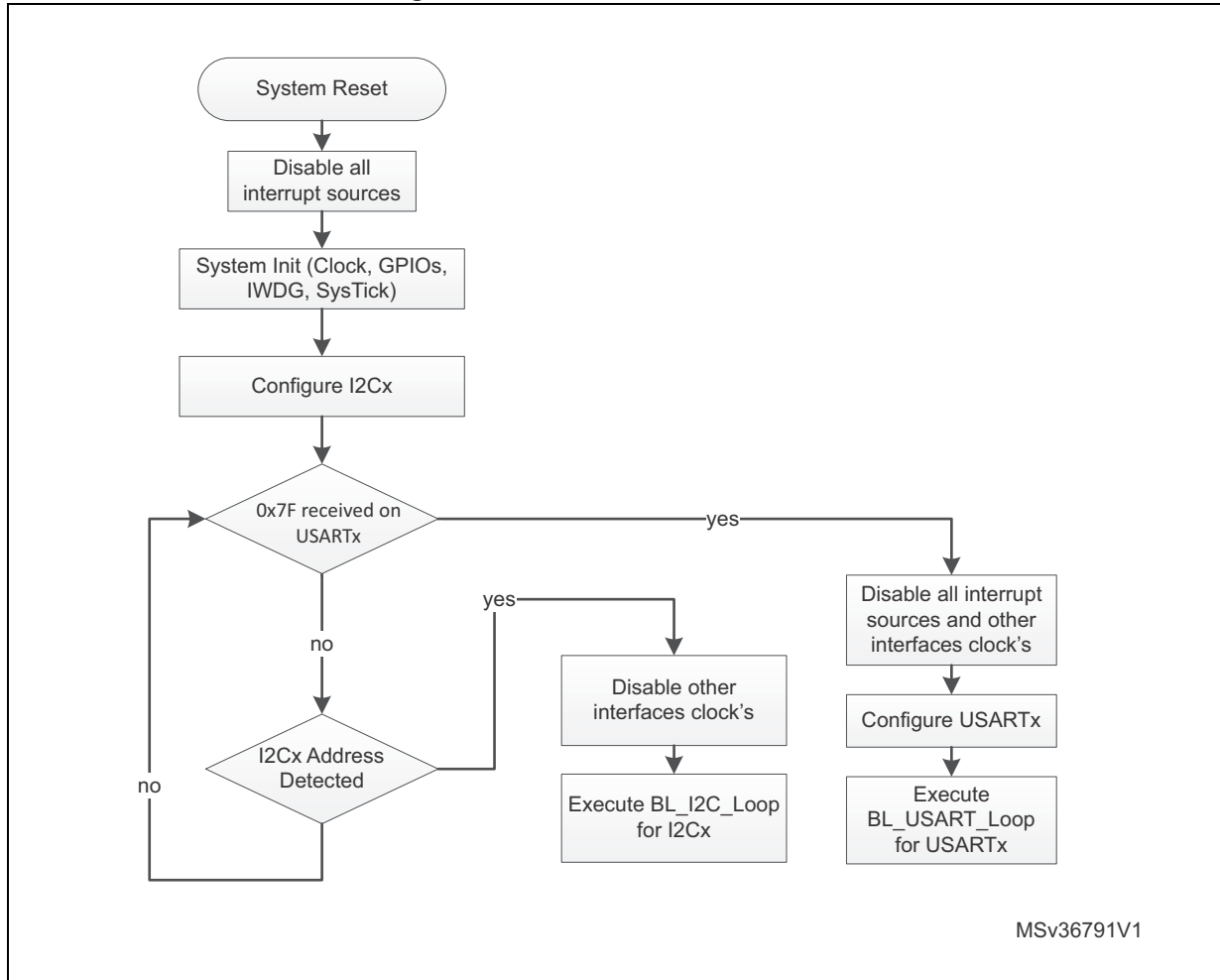

24.3 Bootloader version

The following table lists the STM32F398xx devices bootloader versions.

Table 49.STM32F398xx bootloader versions

Bootloader version number	Description	Known limitations
V5.0	Initial bootloader version	None

25 STM32F40xxx/41xxx devices bootloader

25.1 Bootloader V3.x

25.1.1 Bootloader configuration

The STM32F40xxx/41xxx bootloader is activated by applying pattern1 (described in [Table 2: Bootloader activation patterns](#)). The following table shows the hardware resources used by this bootloader.

Table 50. STM32F40xxx/41xxx configuration in system memory boot mode

Bootloader	Feature/Peripheral	State	Comment
Common to all bootloaders	RCC	HSI enabled	The system clock frequency is 24 MHz using the PLL. The HSI clock source is used at startup (interface detection phase) and when USARTx interfaces are selected (once CAN or DFU bootloader is selected, the clock source will be derived from the external crystal).
		HSE enabled	The system clock frequency is 60 MHz. The HSE clock source is used only when the CAN or the DFU (USB FS Device) interfaces are selected. The external clock must provide a frequency multiple of 1 MHz and ranging from 4 MHz to 26 MHz.
		-	The Clock Security System (CSS) interrupt is enabled for the CAN and DFU bootloaders. Any failure (or removal) of the external clock generates system reset.
	RAM	-	8 Kbyte starting from address 0x20000000 are used by the bootloader firmware.
	System memory	-	30688 byte starting from address 0x1FFF0000 contain the bootloader firmware.
	IWDG	-	The independent watchdog (IWDG) prescaler is configured to its maximum value. It is periodically refreshed to prevent watchdog reset (in case the hardware IWDG option was previously enabled by the user).
	Power	-	Voltage range is set to [1.62 V, 2.1 V]. In this range internal Flash write operations are allowed only in byte format (Half-Word, Word and Double-Word operations are not allowed). The voltage range can be configured in run time using bootloader commands.

Table 50. STM32F40xxx/41xxx configuration in system memory boot mode (continued)

Bootloader	Feature/Peripheral	State	Comment
USART1 bootloader	USART1	Enabled	Once initialized, the USART1 configuration is: 8 bits, even parity and 1 Stop bit.
	USART1_RX pin	Input	PA10 pin: USART1 in reception mode
	USART1_TX pin	Output	PA9 pin: USART1 in transmission mode
USART3 bootloader (on PB10/PB11)	USART3	Enabled	Once initialized, the USART3 configuration is: 8 bits, even parity and 1 Stop bit.
	USART3_RX pin	Input	PB11 pin: USART3 in reception mode
	USART3_TX pin	Output	PB10 pin: USART3 in transmission mode
USART3 bootloader (on PC10/PC11)	USART3	Enabled	Once initialized, the USART3 configuration is: 8 bits, even parity and 1 Stop bit.
	USART3_RX pin	Input	PC11 pin: USART3 in reception mode
	USART3_TX pin	Output	PC10 pin: USART3 in transmission mode
USARTx bootloaders	SysTick timer	Enabled	Used to automatically detect the serial baud rate from the host for USARTx bootloaders.
CAN2 bootloader	CAN2	Enabled	Once initialized, the CAN2 configuration is: Baudrate 125 kbps, 11-bit identifier. Note: CAN1 is clocked during CAN2 bootloader execution because CAN1 manages the communication between CAN2 and SRAM.
	CAN2_RX pin	Input	PB5 pin: CAN2 in reception mode
	CAN2_TX pin	Output	PB13 pin: CAN2 in transmission mode
DFU bootloader	USB	Enabled	USB OTG FS configured in Forced Device mode
	USB_DM pin	Input/Output	PA11: USB DM line.
	USB_DP pin		PA12: USB DP line No external Pull-up resistor is required
CAN2 and DFU bootloaders	TIM11	Enabled	This timer is used to determine the value of the HSE. Once the HSE frequency is determined, the system clock is configured to 60 MHz using PLL and HSE.

The system clock is derived from the embedded internal high-speed RC for USARTx bootloaders. This internal clock is also used for CAN and DFU (USB FS Device) but only for the selection phase. An external clock multiple of 1 MHz (between 4 and 26 MHz) is required for CAN and DFU bootloader execution after the selection phase.

25.1.2 Bootloader selection

The figure below shows the bootloader selection mechanism.

Figure 28. Bootloader V3.x selection for STM32F40xxx/41xxx devices

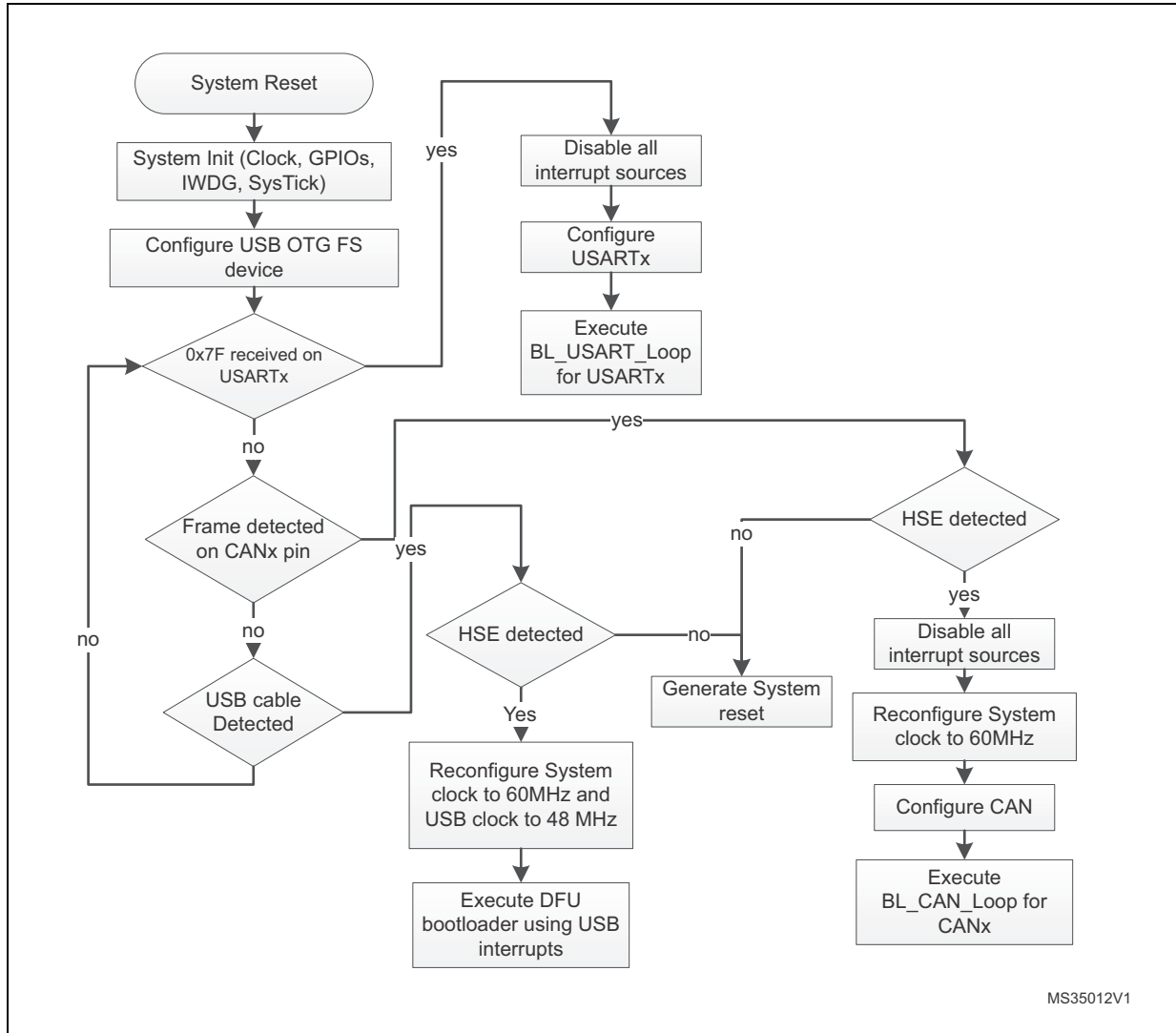

25.1.3 Bootloader version

The following table lists the STM32F40xxx/41xxx devices V3.x bootloader versions:

Table 51. STM32F40xxx/41xxx bootloader V3.x versions

Bootloader version number	Description	Known limitations
V3.0	Initial bootloader version	<ul style="list-style-type: none"> – When a Read Memory command or Write Memory command is issued with an unsupported memory address and a correct address checksum (ie. address 0x6000 0000), the command is aborted by the bootloader device, but the NACK (0x1F) is not sent to the host. As a result, the next 2 bytes (which are the number of bytes to be read/written and its checksum) are considered as a new command and its checksum⁽¹⁾. – Option bytes, OTP and Device Feature descriptors (in DFU interface) are set to “g” instead of “e” (not erasable memory areas).
V3.1	Fix V3.0 limitations. DFU interface robustness enhancement.	<ul style="list-style-type: none"> – For the USART interface, two consecutive NACKs (instead of 1 NACK) are sent when a Read Memory or Write Memory command is sent and the RDP level is active. – For the CAN interface, the Write Unprotect command is not functional. Instead you can use Write Memory command and write directly to the option bytes in order to disable the write protection.

1. If the “number of data - 1” (N-1) to be read/written is not equal to a valid command code (0x00, 0x01, 0x02, 0x11, 0x21, 0x31, 0x43, 0x44, 0x63, 0x73, 0x82 or 0x92), then the limitation is not perceived from the host since the command is NACKed anyway (as an unsupported new command).

25.2 Bootloader V9.x

25.2.1 Bootloader configuration

The STM32F40xxx/41xxx bootloader is activated by applying pattern1 (described in [Table 2: Bootloader activation patterns](#)). The following table shows the hardware resources used by this bootloader.

Note: The bootloader version V9.x is only embedded in STM32F405xx/415xx WCSP90 package devices.

Table 52. STM32F40xxx/41xxx configuration in system memory boot mode

Bootloader	Feature/Peripheral	State	Comment
Common to all bootloaders	RCC	HSI enabled	The system clock frequency is 60 MHz using the PLL. The HSI clock source is used at startup (interface detection phase) and when USART or SPI or I2C interfaces are selected (once CAN or DFU bootloader is selected, the clock source will be derived from the external crystal).
		HSE enabled	The system clock frequency is 60 MHz. The HSE clock source is used only when the CAN or the DFU (USB FS Device) interfaces are selected. The external clock must provide a frequency multiple of 1 MHz and ranging from 4 MHz to 26 MHz.
		-	The Clock Security System (CSS) interrupt is enabled for the CAN and DFU bootloaders. Any failure (or removal) of the external clock generates system reset.
	RAM	-	12 Kbyte starting from address 0x20000000 are used by the bootloader firmware
	System memory	-	30424 byte starting from address 0x1FFF0000, contain the bootloader firmware
	IWDG	-	The independent watchdog (IWDG) prescaler is configured to its maximum value. It is periodically refreshed to prevent watchdog reset (in case the hardware IWDG option was previously enabled by the user).
	Power	-	Voltage range is set to [1.62 V, 2.1 V]. In this range internal Flash write operations are allowed only in byte format (Half-Word, Word and Double-Word operations are not allowed). The voltage range can be configured in run time using bootloader commands.

Table 52. STM32F40xxx/41xxx configuration in system memory boot mode (continued)

Bootloader	Feature/Peripheral	State	Comment
USART1 bootloader	USART1	Enabled	Once initialized the USART1 configuration is: 8-bits, even parity and 1 Stop bit
	USART1_RX pin	Input	PA10 pin: USART1 in reception mode
	USART1_TX pin	Output	PA9 pin: USART1 in transmission mode
USART3 bootloader (on PB10/PB11)	USART3	Enabled	Once initialized the USART3 configuration is: 8-bits, even parity and 1 Stop bit
	USART3_RX pin	Input	PB11 pin: USART3 in reception mode
	USART3_TX pin	Output	PB10 pin: USART3 in transmission mode
USART3 bootloader (on PC10/PC11)	USART3	Enabled	Once initialized the USART3 configuration is: 8-bits, even parity and 1 Stop bit
	USART3_RX pin	Input	PC11 pin: USART3 in reception mode
	USART3_TX pin	Output	PC10 pin: USART3 in transmission mode
USARTx bootloaders	SysTick timer	Enabled	Used to automatically detect the serial baud rate from the host for USARTx bootloaders.
CAN2 bootloader	CAN2	Enabled	Once initialized the CAN2 configuration is: Baudrate 125 kbps, 11-bit identifier. Note: CAN1 is clocked during CAN2 bootloader execution because CAN1 manages the communication between CAN2 and SRAM.
	CAN2_RX pin	Input	PB5 pin: CAN2 in reception mode
	CAN2_TX pin	Output	PB13 pin: CAN2 in transmission mode
I2C1 bootloader	I2C1	Enabled	The I2C1 configuration is: I2C speed: up to 400 KHz, 7-bit address, slave mode, analog filter ON. Slave 7-bit address: 0b0111010x (where x = 0 for write and x = 1 for read).
	I2C1_SCL pin	Input/Output	PB6 pin: clock line is used in open-drain mode.
	I2C1_SDA pin	Input/Output	PB7 pin: data line is used in open-drain mode.
I2C2 bootloader	I2C2	Enabled	The I2C2 configuration is: I2C speed: up to 400 KHz, 7-bit address, slave mode, analog filter ON. Slave 7-bit address: 0b0111010x (where x = 0 for write and x = 1 for read).
	I2C2_SCL pin	Input/Output	PF1 pin: clock line is used in open-drain mode.
	I2C2_SDA pin	Input/Output	PF0 pin: data line is used in open-drain mode.

Table 52. STM32F40xxx/41xxx configuration in system memory boot mode (continued)

Bootloader	Feature/Peripheral	State	Comment
I2C3 bootloader	I2C3	Enabled	The I2C3 configuration is: I2C speed: up to 400 KHz, 7-bit address, slave mode, analog filter ON. Slave 7-bit address: 0b0111010x (where x = 0 for write and x = 1 for read).
	I2C3_SCL pin	Input/Output	PA8 pin: clock line is used in open-drain mode.
	I2C3_SDA pin	Input/Output	PC9 pin: data line is used in open-drain mode.
SPI1 bootloader	SPI1	Enabled	The SPI1 configuration is: slave mode, Full Duplex, 8-bit MSB, Speed up to 8 MHz, Polarity: CPOL Low, CPHA Low, NSS hardware.
	SPI1_MOSI pin	Input	PA7 pin: Slave data Input line, used in Push-pull pull-down mode
	SPI1_MISO pin	Output	PA6 pin: Slave data output line, used in Push-pull pull-down mode
	SPI1_SCK pin	Input	PA5 pin: Slave clock line, used in Push-pull pull-down mode
	SPI1_NSS pin	Input	PA4 pin: Slave Chip Select pin used in Push-pull pull-down mode.
SPI2 bootloader	SPI2	Enabled	The SPI2 configuration is: Slave mode, Full Duplex, 8-bit MSB, Speed up to 8 MHz, Polarity: CPOL Low, CPHA Low, NSS hardware.
	SPI2_MOSI pin	Input	PI3 pin: Slave data Input line, used in Push-pull pull-down mode
	SPI2_MISO pin	Output	PI2 pin: Slave data output line, used in Push-pull pull-down mode
	SPI2_SCK pin	Input	PI1 pin: Slave clock line, used in Push-pull pull-down mode
	SPI2_NSS pin	Input	PI0 pin: Slave Chip Select pin used in Push-pull pull-down mode.
DFU bootloader	USB	Enabled	USB OTG FS configured in Forced Device mode
	USB_DM pin	Input/Output	PA11: USB DM line.
	USB_DP pin		PA12: USB DP line No external Pull-up resistor is required
CAN2 and DFU bootloaders	TIM11	Enabled	This timer is used to determine the value of the HSE. Once the HSE frequency is determined, the system clock is configured to 60 MHz using PLL and HSE.

The system clock is derived from the embedded internal high-speed RC for USARTx, I2Cx and SPIx bootloaders. This internal clock is also used for CAN and DFU (USB FS Device) but only for the selection phase. An external clock multiple of 1 MHz (between 4 and 26 MHz) is required for CAN and DFU bootloader execution after the selection phase.

25.2.2 Bootloader selection

The figure below shows the bootloader selection mechanism.

Figure 29. Bootloader V9.x selection for STM32F40xxx/41xxx

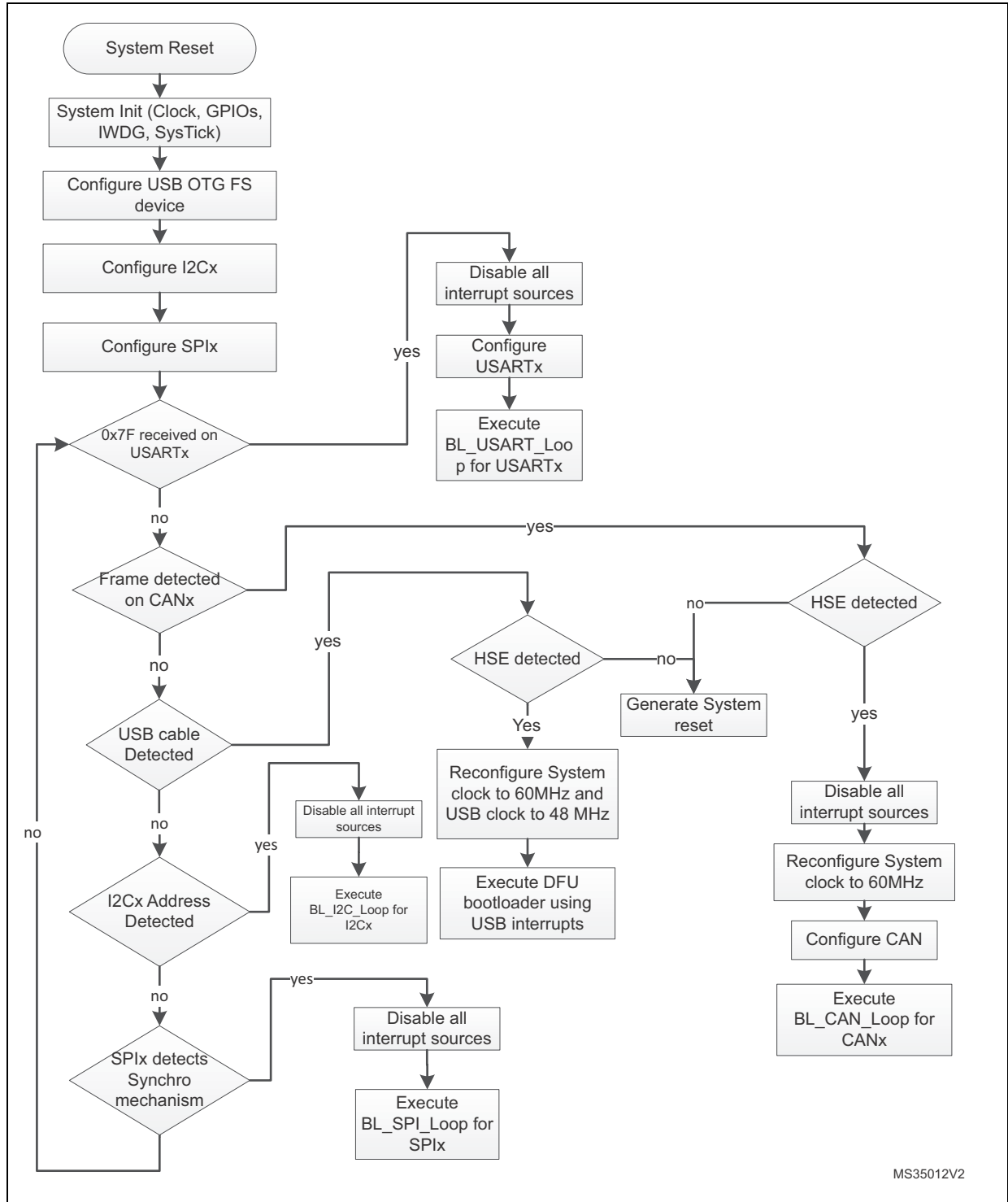

25.2.3 Bootloader version

The following table lists the STM32F40xxx/41xxx devices V9.x bootloader versions.

Table 53. STM32F40xxx/41xxx bootloader V9.x versions

Bootloader version number	Description	Known limitations
V9.0	<p>This bootloader is an updated version of Bootloader v3.1.</p> <p>This new version of bootloader supports I2C1, I2C2, I2C3, SPI1 and SPI2 interfaces.</p> <p>The RAM used by this bootloader is increased from 8Kb to 12Kb.</p> <p>The ID of this bootloader is 0x90.</p> <p>The connection time is increased.</p>	<ul style="list-style-type: none"> – For the USART interface, two consecutive NACKs (instead of 1 NACK) are sent when a Read Memory or Write Memory command is sent and the RDP level is active. – For the CAN interface, the Write Unprotect command is not functional. Instead you can use Write Memory command and write directly to the option bytes in order to disable the write protection.

26 STM32F401xB(C) devices bootloader

26.1 Bootloader configuration

The STM32F401xB(C) bootloader is activated by applying pattern1 (described in [Table 2: Bootloader activation patterns](#)). The following table shows the hardware resources used by this bootloader.

Table 54. STM32F401xB(C) configuration in system memory boot mode

Bootloader	Feature/Peripheral	State	Comment
Common to all bootloaders	RCC	HSI enabled	The system clock frequency is 60 MHz using the PLL. The HSI clock source is used at startup (interface detection phase) and when USART or SPI or I2C interface is selected (once DFU bootloader is selected, the clock source will be derived from the external crystal).
		HSE enabled	The system clock frequency is 60 MHz. The HSE clock source is used only when the DFU (USB FS Device) interface is selected. The external clock must provide a frequency multiple of 1 MHz and ranging from 4 MHz to 26 MHz.
		-	The Clock Security System (CSS) interrupt is enabled for the CAN and DFU bootloaders. Any failure (or removal) of the external clock generates system reset.
	RAM	-	12 Kbyte starting from address 0x20000000 are used by the bootloader firmware
	System memory	-	30424 byte starting from address 0x1FFF0000, contain the bootloader firmware
	IWDG	-	The independent watchdog (IWDG) prescaler is configured to its maximum value. It is periodically refreshed to prevent watchdog reset (in case the hardware IWDG option was previously enabled by the user).
	Power	-	Voltage range is set to [1.62 V, 2.1 V]. In this range internal Flash write operations are allowed only in byte format (Half-Word, Word and Double-Word operations are not allowed). The voltage range can be configured in run time using bootloader commands.

Table 54. STM32F401xB(C) configuration in system memory boot mode (continued)

Bootloader	Feature/Peripheral	State	Comment
USART1 bootloader	USART1	Enabled	Once initialized the USART1 configuration is: 8-bits, even parity and 1 Stop bit
	USART1_RX pin	Input	PA10 pin: USART1 in reception mode
	USART1_TX pin	Output	PA9 pin: USART1 in transmission mode
USART2 bootloader	USART2	Enabled	Once initialized the USART2 configuration is: 8-bits, even parity and 1 Stop bit
	USART2_RX pin	Input	PD6 pin: USART2 in reception mode
	USART2_TX pin	Output	PD5 pin: USART2 in transmission mode
USARTx bootloaders	SysTick timer	Enabled	Used to automatically detect the serial baud rate from the host for USARTx bootloaders.
I2C1 bootloader	I2C1	Enabled	The I2C1 configuration is: I2C speed: up to 400 KHz, 7-bit address, slave mode, analog filter ON. Slave 7-bit address: 0b0111001x (where x = 0 for write and x = 1 for read)
	I2C1_SCL pin	Input/Output	PB6 pin: clock line is used in open-drain mode.
	I2C1_SDA pin	Input/Output	PB7 pin: data line is used in open-drain mode.
I2C2 bootloader	I2C2	Enabled	The I2C2 configuration is: I2C speed: up to 400 KHz, 7-bit address, slave mode, analog filter ON. Slave 7-bit address: 0b0111001x (where x = 0 for write and x = 1 for read)
	I2C2_SCL pin	Input/Output	PB10 pin: clock line is used in open-drain mode.
	I2C2_SDA pin	Input/Output	PB3 pin: data line is used in open-drain mode.
I2C3 bootloader	I2C3	Enabled	The I2C3 configuration is: I2C speed: up to 400 KHz, 7-bit address, slave mode, analog filter ON. Slave 7-bit address: 0b0111001x (where x = 0 for write and x = 1 for read)
	I2C3_SCL pin	Input/Output	PA8 pin: clock line is used in open-drain mode.
	I2C3_SDA pin	Input/Output	PB4 pin: data line is used in open-drain mode.

Table 54. STM32F401xB(C) configuration in system memory boot mode (continued)

Bootloader	Feature/Peripheral	State	Comment
SPI1 bootloader	SPI1	Enabled	The SPI1 configuration is: Slave mode, Full Duplex, 8-bit MSB, Speed up to 8 MHz, Polarity: CPOL Low, CPHA Low, NSS hardware.
	SPI1_MOSI pin	Input	PA7 pin: Slave data Input line, used in Push-pull pull-down mode
	SPI1_MISO pin	Output	PA6 pin: Slave data output line, used in Push-pull pull-down mode
	SPI1_SCK pin	Input	PA5 pin: Slave clock line, used in Push-pull pull-down mode
	SPI1_NSS pin	Input	PA4 pin: Slave Chip Select pin used in Push-pull pull-down mode.
SPI2 bootloader	SPI2	Enabled	The SPI2 configuration is: Slave mode, Full Duplex, 8-bit MSB, Speed up to 8 MHz, Polarity: CPOL Low, CPHA Low, NSS hardware.
	SPI2_MOSI pin	Input	PB15 pin: Slave data Input line, used in Push-pull pull-down mode
	SPI2_MISO pin	Output	PB14 pin: Slave data output line, used in Push-pull pull-down mode
	SPI2_SCK pin	Input	PB13 pin: Slave clock line, used in Push-pull pull-down mode
	SPI2_NSS pin	Input	PB12 pin: Slave Chip Select pin used in Push-pull pull-down mode.
SPI3 bootloader	SPI3	Enabled	The SPI3 configuration is: Slave mode, Full Duplex, 8-bit MSB, Speed up to 8 MHz, Polarity: CPOL Low, CPHA Low, NSS hardware.
	SPI3_MOSI pin	Input	PC12 pin: Slave data Input line, used in Push-pull pull-down mode
	SPI3_MISO pin	Output	PC11 pin: Slave data output line, used in Push-pull pull-down mode
	SPI3_SCK pin	Input	PC10 pin: Slave clock line, used in Push-pull pull-down mode
	SPI3_NSS pin	Input	PA15 pin: Slave Chip Select pin used in Push-pull pull-down mode.

Table 54. STM32F401xB(C) configuration in system memory boot mode (continued)

Bootloader	Feature/Peripheral	State	Comment
DFU bootloader	USB	Enabled	USB OTG FS configured in Forced Device mode
	USB_DM pin	Input/Output	PA11: USB DM line.
	USB_DP pin		PA12: USB DP line No external Pull-up resistor is required
	TIM11	Enabled	This timer is used to determine the value of the HSE. Once the HSE frequency is determined, the system clock is configured to 60 MHz using PLL and HSE.

The system clock is derived from the embedded internal high-speed RC for USARTx, I2Cx and SPIx bootloaders. This internal clock is also used for CAN and DFU (USB FS Device) but only for the selection phase. An external clock multiple of 1 MHz (between 4 and 26 MHz) is required for CAN and DFU bootloader execution after the selection phase.

26.2 Bootloader selection

The figure below shows the bootloader selection mechanism.

Figure 30. Bootloader selection for STM32F401xB(C)

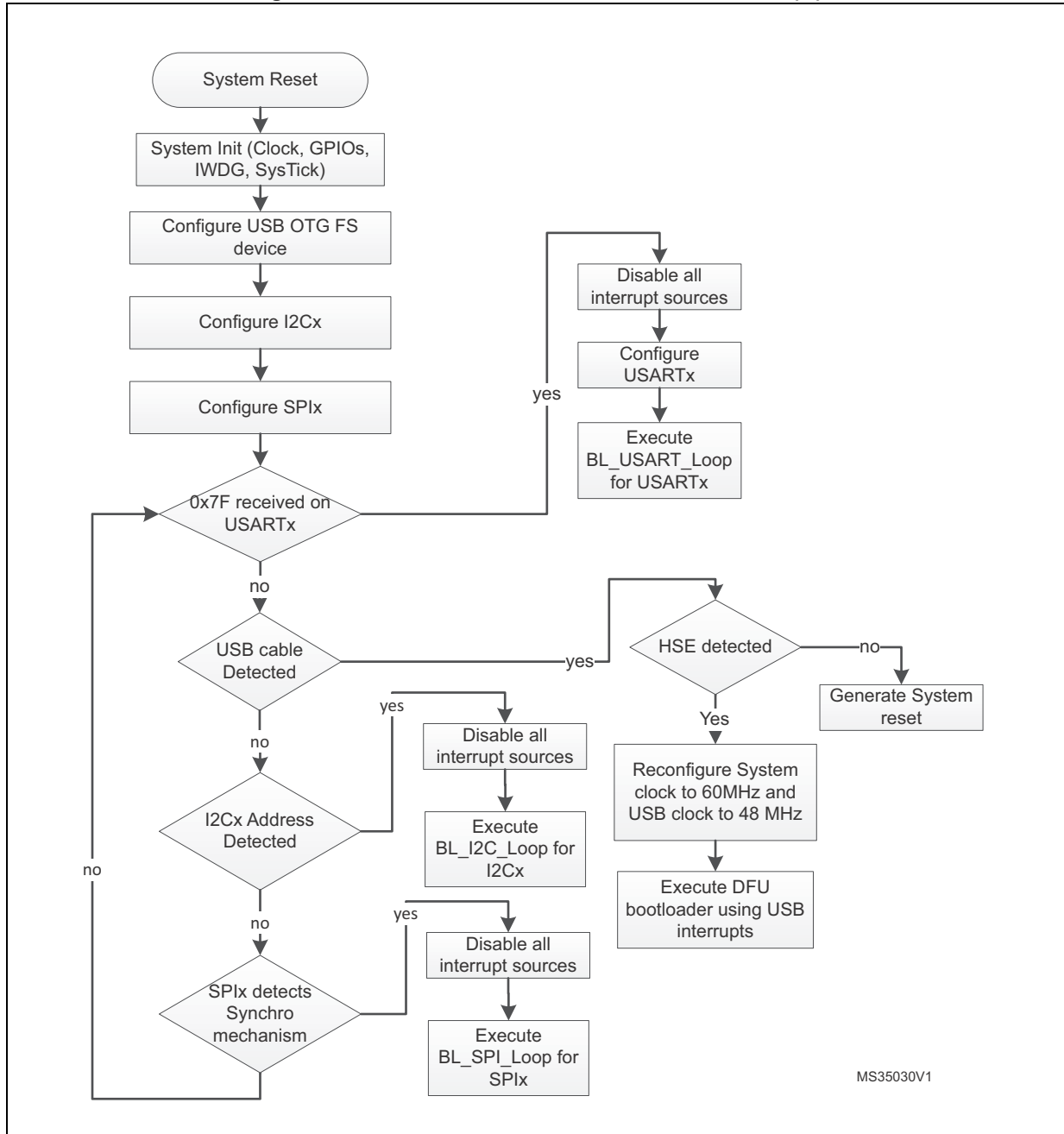

26.3 Bootloader version

The following table lists the STM32F401xB(C) devices bootloader version.

Table 55. STM32F401xB(C) bootloader versions

Bootloader version number	Description	Known limitations
V13.0	Initial bootloader version	None

27 STM32F401xD(E) devices bootloader

27.1 Bootloader configuration

The STM32F401xD(E) bootloader is activated by applying pattern1 (described in [Table 2: Bootloader activation patterns](#)). The following table shows the hardware resources used by this bootloader.

Table 56. STM32F401xD(E) configuration in system memory boot mode

Bootloader	Feature/Peripheral	State	Comment
Common to all bootloaders	RCC	HSI enabled	The system clock frequency is 60 MHz using the PLL. The HSI clock source is used at startup (interface detection phase) and when USART or SPI or I2C interface is selected (once DFU bootloader is selected, the clock source will be derived from the external crystal).
		HSE enabled	The system clock frequency is 60 MHz. The HSE clock source is used only when the DFU (USB FS Device) interface is selected. The external clock must provide a frequency multiple of 1 MHz and ranging from 4 MHz to 26 MHz.
		-	The Clock Security System (CSS) interrupt is enabled for the CAN and DFU bootloaders. Any failure (or removal) of the external clock generates system reset.
	RAM	-	12 Kbyte starting from address 0x20000000 are used by the bootloader firmware
	System memory	-	30424 byte starting from address 0x1FFF0000, contain the bootloader firmware
	IWDG	-	The independent watchdog (IWDG) prescaler is configured to its maximum value. It is periodically refreshed to prevent watchdog reset (in case the hardware IWDG option was previously enabled by the user).
	Power	-	Voltage range is set to [1.62 V, 2.1 V]. In this range internal Flash write operations are allowed only in byte format (Half-Word, Word and Double-Word operations are not allowed). The voltage range can be configured in run time using bootloader commands.

Table 56. STM32F401xD(E) configuration in system memory boot mode (continued)

Bootloader	Feature/Peripheral	State	Comment
USART1 bootloader	USART1	Enabled	Once initialized the USART1 configuration is: 8-bits, even parity and 1 Stop bit
	USART1_RX pin	Input	PA10 pin: USART1 in reception mode
	USART1_TX pin	Output	PA9 pin: USART1 in transmission mode
USART2 bootloader	USART2	Enabled	Once initialized the USART2 configuration is: 8-bits, even parity and 1 Stop bit
	USART2_RX pin	Input	PD6 pin: USART2 in reception mode
	USART2_TX pin	Output	PD5 pin: USART2 in transmission mode
USARTx bootloaders	SysTick timer	Enabled	Used to automatically detect the serial baud rate from the host for USARTx bootloaders.
I2C1 bootloader	I2C1	Enabled	The I2C1 configuration is: I2C speed: up to 400 KHz, 7-bit address, slave mode, analog filter ON. Slave 7-bit address: 0b0111001x (where x = 0 for write and x = 1 for read)
	I2C1_SCL pin	Input/Output	PB6 pin: clock line is used in open-drain mode.
	I2C1_SDA pin	Input/Output	PB7 pin: data line is used in open-drain mode.
I2C2 bootloader	I2C2	Enabled	The I2C2 configuration is: I2C speed: up to 400 KHz, 7-bit address, slave mode, analog filter ON. Slave 7-bit address: 0b0111001x (where x = 0 for write and x = 1 for read)
	I2C2_SCL pin	Input/Output	PB10 pin: clock line is used in open-drain mode.
	I2C2_SDA pin	Input/Output	PB3 pin: data line is used in open-drain mode.
I2C3 bootloader	I2C3	Enabled	The I2C3 configuration is: I2C speed: up to 400 KHz, 7-bit address, slave mode, analog filter ON. Slave 7-bit address: 0b0111001x (where x = 0 for write and x = 1 for read)
	I2C3_SCL pin	Input/Output	PA8 pin: clock line is used in open-drain mode.
	I2C3_SDA pin	Input/Output	PB4 pin: data line is used in open-drain mode.

Table 56. STM32F401xD(E) configuration in system memory boot mode (continued)

Bootloader	Feature/Peripheral	State	Comment
SPI1 bootloader	SPI1	Enabled	The SPI1 configuration is: Slave mode, Full Duplex, 8-bit MSB, Speed up to 8 MHz, Polarity: CPOL Low, CPHA Low, NSS hardware.
	SPI1_MOSI pin	Input	PA7 pin: Slave data Input line, used in Push-pull pull-down mode
	SPI1_MISO pin	Output	PA6 pin: Slave data output line, used in Push-pull pull-down mode
	SPI1_SCK pin	Input	PA5 pin: Slave clock line, used in Push-pull pull-down mode
	SPI1_NSS pin	Input	PA4 pin: Slave Chip Select pin used in Push-pull pull-down mode.
SPI2 bootloader	SPI2	Enabled	The SPI2 configuration is: Slave mode, Full Duplex, 8-bit MSB, Speed up to 8 MHz, Polarity: CPOL Low, CPHA Low, NSS hardware.
	SPI2_MOSI pin	Input	PB15 pin: Slave data Input line, used in Push-pull pull-down mode
	SPI2_MISO pin	Output	PB14 pin: Slave data output line, used in Push-pull pull-down mode
	SPI2_SCK pin	Input	PB13 pin: Slave clock line, used in Push-pull pull-down mode
	SPI2_NSS pin	Input	PB12 pin: Slave Chip Select pin used in Push-pull pull-down mode.
SPI3 bootloader	SPI3	Enabled	The SPI3 configuration is: Slave mode, Full Duplex, 8-bit MSB, Speed up to 8 MHz, Polarity: CPOL Low, CPHA Low, NSS hardware.
	SPI3_MOSI pin	Input	PC12 pin: Slave data Input line, used in Push-pull pull-down mode
	SPI3_MISO pin	Output	PC11 pin: Slave data output line, used in Push-pull pull-down mode
	SPI3_SCK pin	Input	PC10 pin: Slave clock line, used in Push-pull pull-down mode
	SPI3_NSS pin	Input	PA15 pin: Slave Chip Select pin used in Push-pull pull-down mode.
DFU bootloader	USB	Enabled	USB OTG FS configured in Forced Device mode
	USB_DM pin	Input/Output	PA11: USB DM line.
	USB_DP pin		PA12: USB DP line No external Pull-up resistor is required
	TIM11	Enabled	This timer is used to determine the value of the HSE. Once the HSE frequency is determined, the system clock is configured to 60 MHz using PLL and HSE.

The system clock is derived from the embedded internal high-speed RC for USARTx, I2Cx and SPIx bootloaders. This internal clock is also used for CAN and DFU (USB FS Device) but only for the selection phase. An external clock multiple of 1 MHz (between 4 and 26 MHz) is required for CAN and DFU bootloader execution after the selection phase.

27.2 Bootloader selection

The figure below shows the bootloader selection mechanism.

Figure 31. Bootloader selection for STM32F401xD(E)

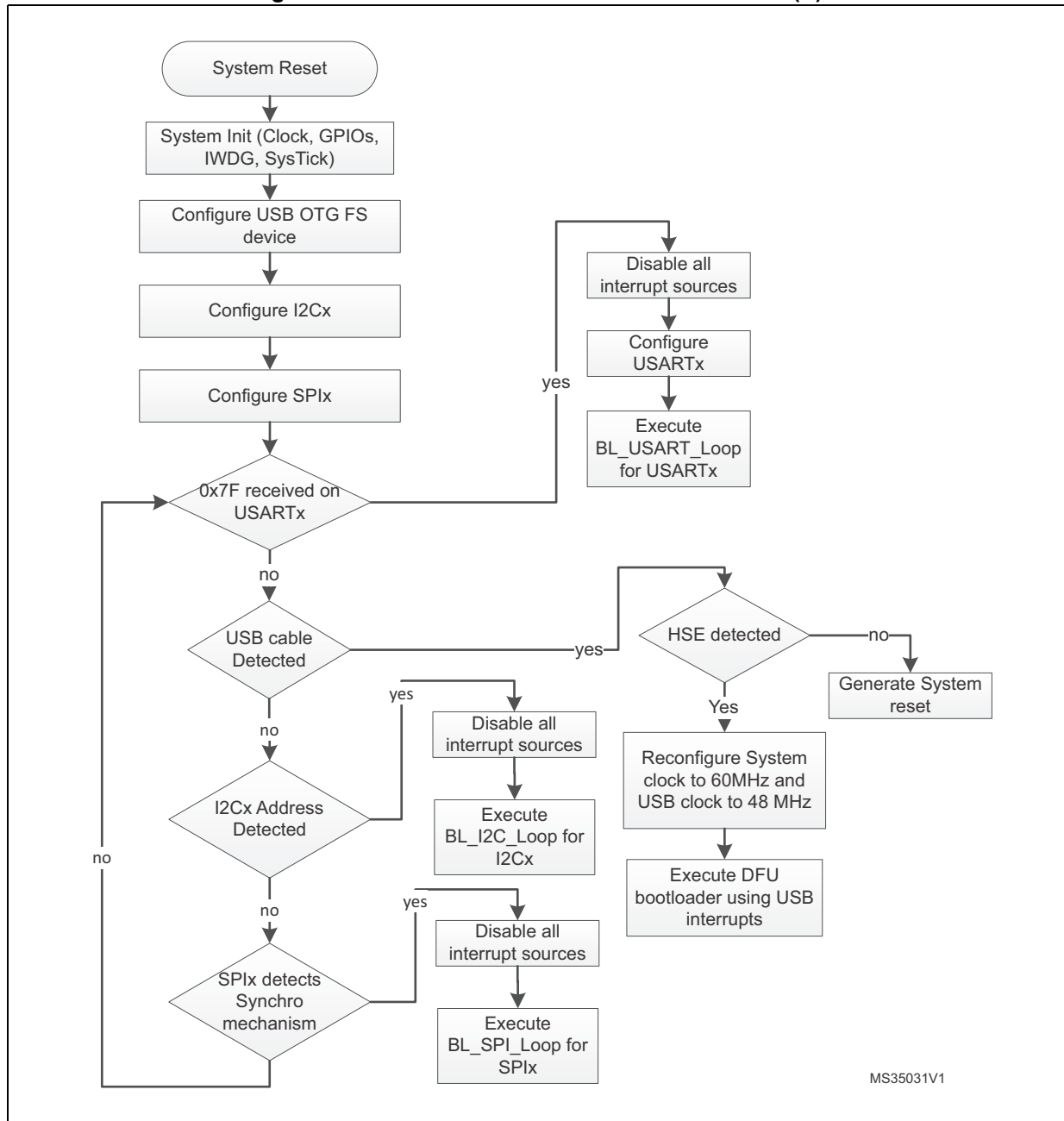

MS35031V1

27.3 Bootloader version

The following table lists the STM32F401xD(E) devices bootloader version.

Table 57. STM32F401xD(E) bootloader versions

Bootloader version number	Description	Known limitations
V13.1	Initial bootloader version	None

28 STM32F410xx device bootloader

28.1 Bootloader configuration

The STM32F410xx bootloader is activated by applying pattern1 (described in [Table 2: Bootloader activation patterns](#)). The following table shows the hardware resources used by this bootloader.

Table 58. STM32F410xx configuration in system memory boot mode

Bootloader	Feature/Peripheral	State	Comment
Common to all bootloaders	RCC	HSI enabled	The HSI is used at startup as clock source for system clock configured to 60 MHz and for USART and I2C bootloader operation.
	RAM	-	5 Kbyte starting from address 0x20000000 are used by the bootloader firmware
	System memory	-	30431 byte starting from address 0x1FF00000, contain the bootloader firmware
	IWDG	-	The independent watchdog (IWDG) prescaler is configured to its maximum value. It is periodically refreshed to prevent watchdog reset (in case the hardware IWDG option was previously enabled by the user).
	Power	-	The voltage range is [1.8V, 3.6V] In this range: - Flash wait states 3. - System clock Frequency 60 MHz. - ART Accelerator enabled. - Flash write operation by byte (refer to Bootloader Memory Management section for more information).
USART1 bootloader	USART1	Enabled	Once initialized the USART1 configuration is: 8-bits, even parity and 1 Stop bit
	USART1_RX pin	Input	PA10 pin: USART1 in reception mode
	USART1_TX pin	Output	PA9 pin: USART1 in transmission mode
USART2 bootloader	USART2	Enabled	Once initialized the USART2 configuration is: 8-bits, even parity and 1 Stop bit
	USART2_RX pin	Input	PA3 pin: USART2 in reception mode
	USART2_TX pin	Output	PA2 pin: USART2 in transmission mode
USARTx bootloaders	SysTick timer	Enabled	Used to automatically detect the serial baud rate from the host for USARTx bootloaders.

Table 58. STM32F410xx configuration in system memory boot mode (continued)

Bootloader	Feature/Peripheral	State	Comment
I2C1 bootloader	I2C1	Enabled	The I2C1 configuration is: I2C speed: up to 400 KHz, 7-bit address, slave mode, analog filter ON. Slave 7-bit address: 0b1000111x (where x = 0 for write and x = 1 for read)
	I2C1_SCL pin	Input/Output	PB6 pin: clock line is used in open-drain mode.
	I2C1_SDA pin	Input/Output	PB7 pin: data line is used in open-drain mode.
I2C2 bootloader	I2C2	Enabled	The I2C2 configuration is: I2C speed: up to 400 KHz, 7-bit address, slave mode, analog filter ON. Slave 7-bit address: 0b1000111x (where x = 0 for write and x = 1 for read)
	I2C2_SCL pin	Input/Output	PB10 pin: clock line is used in open-drain mode.
	I2C2_SDA pin	Input/Output	PB11 pin: data line is used in open-drain mode.
I2C4 bootloader	I2C4	Enabled	The I2C4 configuration is: I2C speed: up to 1 MHz, 7-bit address, slave mode, analog filter ON. Slave 7-bit address: 0b1000111x (where x = 0 for write and x = 1 for read)
	I2C4_SCL pin	Input/Output	PB15 pin: clock line is used in open-drain mode for STM32F410Cx/Rx devices. PB10 pin: clock line is used in open-drain mode for STM32F410Tx devices.
	I2C4_SDA pin	Input/Output	PB14 pin: data line is used in open-drain mode for STM32F410Cx/Rx devices. PB3 pin: data line is used in open-drain mode for STM32F410Tx devices.

Table 58. STM32F410xx configuration in system memory boot mode (continued)

Bootloader	Feature/Peripheral	State	Comment
SPI1 bootloader	SPI1	Enabled	The SPI1 configuration is: Slave mode, Full Duplex, 8-bit MSB, Speed up to 8MHz, Polarity: CPOL Low, CPHA Low, NSS hardware.
	SPI1_MOSI pin	Input	PA7 pin: Slave data Input line, used in Push-pull pull-down mode for STM32F410Cx/Rx devices. PB5 pin: Slave data Input line, used in Push-pull pull-down mode for STM32F410Tx devices.
	SPI1_MISO pin	Output	PA6 pin: Slave data output line, used in Push-pull pull-down mode for STM32F410Cx/Rx devices. PB4 pin: Slave data output line, used in Push-pull pull-down mode for STM32F410Tx devices.
	SPI1_SCK pin	Input	PA5 pin: Slave clock line, used in Push- pull pull-down mode.
	SPI1_NSS pin	Input	PA4 pin: Slave Chip Select pin used in Push-pull pull-up mode for STM32F410Cx/Rx devices. PA15 pin: Slave Chip Select pin used in Push-pull pull-up mode for STM32F410Tx devices.
SPI2 bootloader	SPI2	Enabled	The SPI2 configuration is: Slave mode, Full Duplex, 8-bit MSB, Speed up to 8MHz, Polarity: CPOL Low, CPHA Low, NSS hardware.
	SPI2_MOSI pin	Input	PC3 pin: Slave data Input line, used in Push-pull pull-down mode
	SPI2_MISO pin	Output	PC2 pin: Slave data output line, used in Push-pull pull-down mode
	SPI2_SCK pin	Input	PB13 pin: Slave clock line, used in Push- pull pull-down mode
	SPI2_NSS pin	Input	PB12 pin: Slave Chip Select pin used in Push-pull pull-up mode.

The system clock is derived from the embedded internal high-speed RC for all bootloader interfaces. No external quartz is required for bootloader operations.

28.2 Bootloader selection

The [Figure 32](#) shows the bootloader selection mechanism.

Figure 32.Bootloader V11.x selection for STM32F410xx

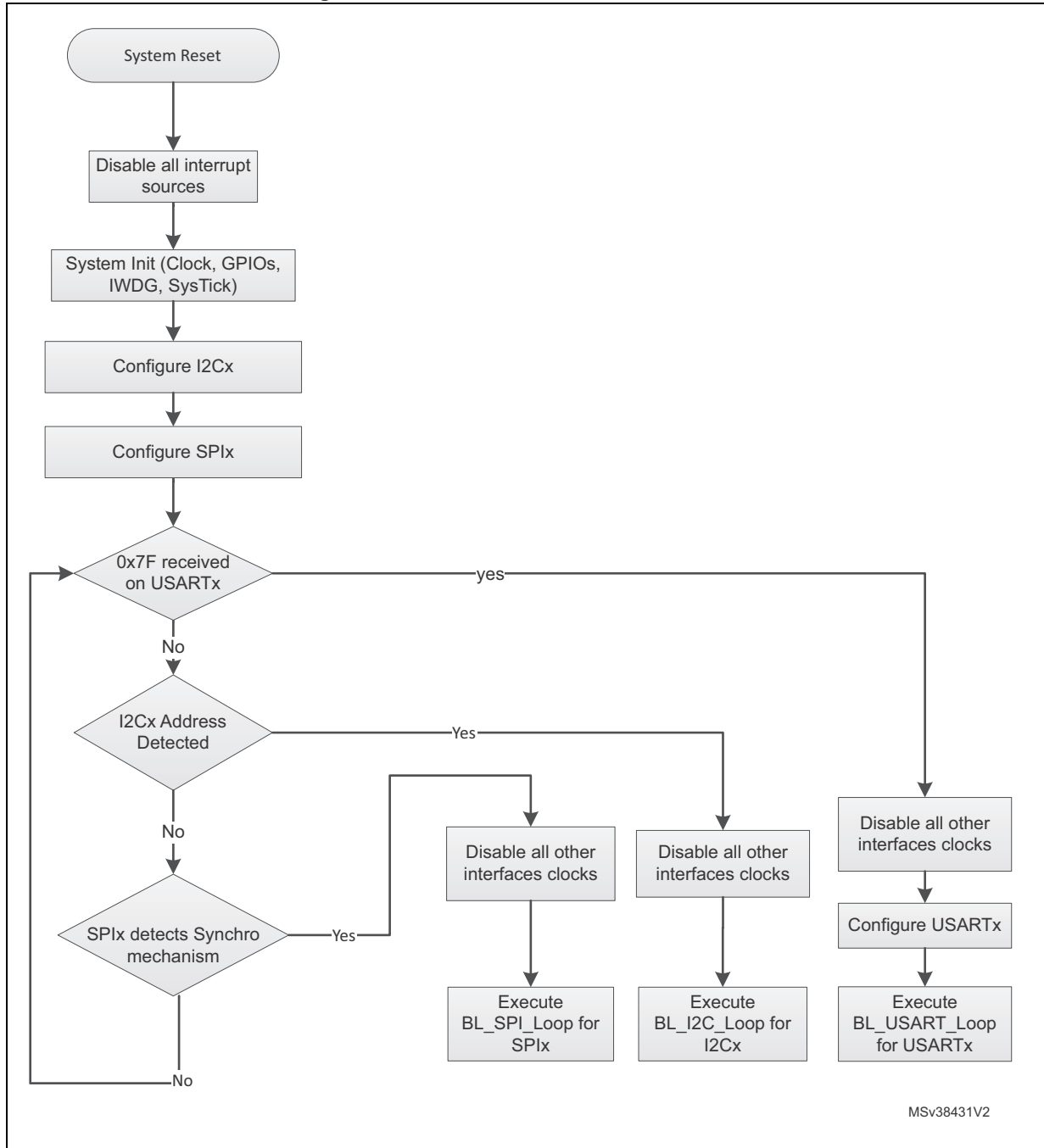

28.3 Bootloader version

The following table lists the STM32F410xx devices bootloader V11.x versions.

Table 59. STM32F410xx bootloader V11.x versions

Bootloader version number	Description	Known limitations
V11.0	Initial bootloader version	None
V11.1	Support I2C4 and SPI1 for STM32F410Tx devices.	None

29 STM32F411xx devices bootloader

29.1 Bootloader configuration

The STM32F411xx bootloader is activated by applying pattern1 (described in [Table 2: Bootloader activation patterns](#)). The following table shows the hardware resources used by this bootloader.

Table 60. STM32F411xx configuration in system memory boot mode

Bootloader	Feature/Peripheral	State	Comment
Common to all bootloaders	RCC	HSI enabled	The system clock frequency is 60 MHz using the PLL. The HSI clock source is used at startup (interface detection phase) and when USART or SPI or I2C interface is selected (once DFU bootloader is selected, the clock source will be derived from the external crystal).
		HSE enabled	The system clock frequency is 60 MHz. The HSE clock source is used only when the DFU (USB FS Device) interface is selected. The external clock must provide a frequency multiple of 1 MHz and ranging from 4 MHz to 26 MHz.
		-	The Clock Security System (CSS) interrupt is enabled for the CAN and DFU bootloaders. Any failure (or removal) of the external clock generates system reset.
	RAM	-	12 Kbyte starting from address 0x20000000 are used by the bootloader firmware
	System memory	-	30424 byte starting from address 0x1FFF0000, contain the bootloader firmware
	IWDG	-	The independent watchdog (IWDG) prescaler is configured to its maximum value. It is periodically refreshed to prevent watchdog reset (in case the hardware IWDG option was previously enabled by the user).
Power	-	Voltage range is set to [1.62 V, 2.1 V]. In this range internal Flash write operations are allowed only in byte format (Half-Word, Word and Double-Word operations are not allowed). The voltage range can be configured in run time using bootloader commands.	

Table 60. STM32F411xx configuration in system memory boot mode (continued)

Bootloader	Feature/Peripheral	State	Comment
USART1 bootloader	USART1	Enabled	Once initialized the USART1 configuration is: 8-bits, even parity and 1 Stop bit
	USART1_RX pin	Input	PA10 pin: USART1 in reception mode
	USART1_TX pin	Output	PA9 pin: USART1 in transmission mode
USART2 bootloader	USART2	Enabled	Once initialized the USART2 configuration is: 8-bits, even parity and 1 Stop bit
	USART2_RX pin	Input	PD6 pin: USART2 in reception mode
	USART2_TX pin	Output	PD5 pin: USART2 in transmission mode
USARTx bootloaders	SysTick timer	Enabled	Used to automatically detect the serial baud rate from the host for USARTx bootloaders.
I2C1 bootloader	I2C1	Enabled	The I2C1 configuration is: I2C speed: up to 400 KHz, 7-bit address, slave mode, analog filter ON. Slave 7-bit address: 0b0111001x (where x = 0 for write and x = 1 for read)
	I2C1_SCL pin	Input/Output	PB6 pin: clock line is used in open-drain mode.
	I2C1_SDA pin	Input/Output	PB7 pin: data line is used in open-drain mode.
I2C2 bootloader	I2C2	Enabled	The I2C2 configuration is: I2C speed: up to 400 KHz, 7-bit address, slave mode, analog filter ON. Slave 7-bit address: 0b0111001x (where x = 0 for write and x = 1 for read)
	I2C2_SCL pin	Input/Output	PB10 pin: clock line is used in open-drain mode.
	I2C2_SDA pin	Input/Output	PB3 pin: data line is used in open-drain mode.
I2C3 bootloader	I2C3	Enabled	The I2C3 configuration is: I2C speed: up to 400 KHz, 7-bit address, slave mode, analog filter ON. Slave 7-bit address: 0b0111001x (where x = 0 for write and x = 1 for read)
	I2C3_SCL pin	Input/Output	PA8 pin: clock line is used in open-drain mode.
	I2C3_SDA pin	Input/Output	PB4 pin: data line is used in open-drain mode.

Table 60. STM32F411xx configuration in system memory boot mode (continued)

Bootloader	Feature/Peripheral	State	Comment
SPI1 bootloader	SPI1	Enabled	The SPI1 configuration is: Slave mode, Full Duplex, 8-bit MSB, Speed up to 8 MHz, Polarity: CPOL Low, CPHA Low, NSS hardware.
	SPI1_MOSI pin	Input	PA7 pin: Slave data Input line, used in Push-pull pull-down mode
	SPI1_MISO pin	Output	PA6 pin: Slave data output line, used in Push-pull pull-down mode
	SPI1_SCK pin	Input	PA5 pin: Slave clock line, used in Push-pull pull-down mode
	SPI1_NSS pin	Input	PA4 pin: Slave Chip Select pin used in Push-pull pull-down mode.
SPI2 bootloader	SPI2	Enabled	The SPI2 configuration is: Slave mode, Full Duplex, 8-bit MSB, Speed up to 8 MHz, Polarity: CPOL Low, CPHA Low, NSS hardware.
	SPI2_MOSI pin	Input	PB15 pin: Slave data Input line, used in Push-pull pull-down mode
	SPI2_MISO pin	Output	PB14 pin: Slave data output line, used in Push-pull pull-down mode
	SPI2_SCK pin	Input	PB13 pin: Slave clock line, used in Push-pull pull-down mode
	SPI2_NSS pin	Input	PB12 pin: Slave Chip Select pin used in Push-pull pull-down mode.
SPI3 bootloader	SPI3	Enabled	The SPI3 configuration is: Slave mode, Full Duplex, 8-bit MSB, Speed up to 8 MHz, Polarity: CPOL Low, CPHA Low, NSS hardware.
	SPI3_MOSI pin	Input	PC12 pin: Slave data Input line, used in Push-pull pull-down mode
	SPI3_MISO pin	Output	PC11 pin: Slave data output line, used in Push-pull pull-down mode
	SPI3_SCK pin	Input	PC10 pin: Slave clock line, used in Push-pull pull-down mode
	SPI3_NSS pin	Input	PA15 pin: Slave Chip Select pin used in Push-pull pull-down mode.

Table 60. STM32F411xx configuration in system memory boot mode (continued)

Bootloader	Feature/Peripheral	State	Comment
DFU bootloader	USB	Enabled	USB OTG FS configured in Forced Device mode
	USB_DM pin	Input/Output	PA11: USB DM line.
	USB_DP pin		PA12: USB DP line No external Pull-up resistor is required
	TIM11	Enabled	This timer is used to determine the value of the HSE. Once the HSE frequency is determined, the system clock is configured to 60 MHz using PLL and HSE.

The system clock is derived from the embedded internal high-speed RC for USARTx, I2Cx and SPIx bootloaders. This internal clock is also used for CAN and DFU (USB FS Device) but only for the selection phase. An external clock multiple of 1 MHz (between 4 and 26 MHz) is required for CAN and DFU bootloader execution after the selection phase.

29.2 Bootloader selection

The figure below shows the bootloader selection mechanism.

Figure 33. Bootloader selection for STM32F411xx

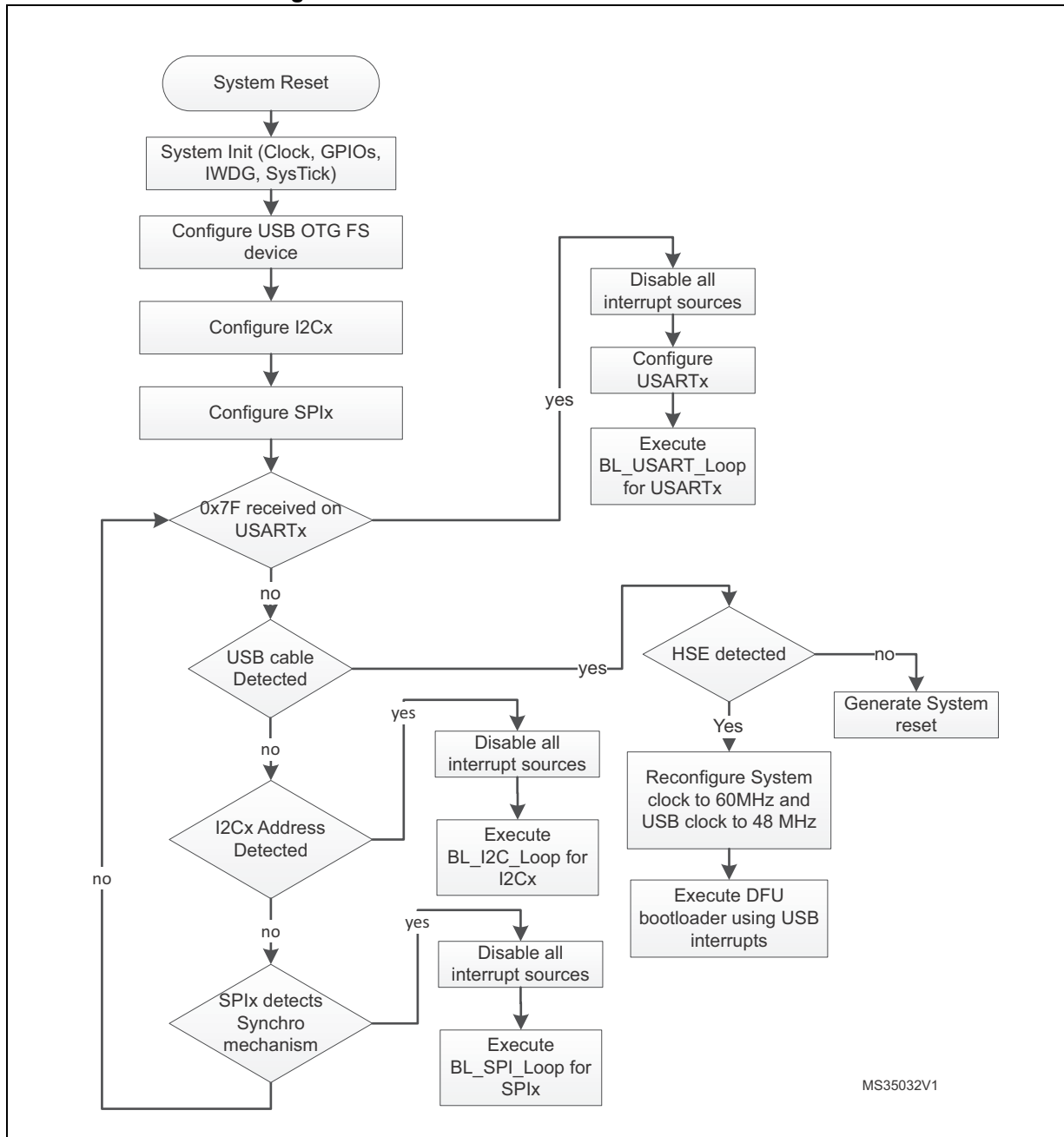

29.3 Bootloader version

The following table lists the STM32F411xx devices bootloader version.

Table 61. STM32F411xx bootloader versions

Bootloader version number	Description	Known limitations
V13.0	Initial bootloader version	None

30 STM32F412xx devices bootloader

30.1 Bootloader configuration

The STM32F412xx bootloader is activated by applying pattern1 (described in [Table 2: Bootloader activation patterns](#)). The table shows the hardware resources used by this bootloader.

Table 62. STM32F412xx configuration in system memory boot mode

Bootloader	Feature/Peripheral	State	Comment
Common to all bootloaders	RCC	HSI enabled	The HSI is used at startup as clock source for system clock configured to 60 MHz and for USART and I2C bootloader operation.
		HSE enabled	The HSE is used only when the CAN or the DFU (USB FS Device) interfaces are selected. In this case the system clock configured to 60 MHz with HSE as clock source. The HSE frequency must be multiple of 1 MHz and ranging from 4 MHz to 26 MHz.
		-	The Clock Security System (CSS) interrupt is enabled for the CAN and DFU bootloaders. Any failure (or removal) of the external clock generates system reset.
	RAM	-	16 Kbyte starting from address 0x20000000 are used by the bootloader firmware
	System memory	-	61440 byte starting from address 0x1FF00000, contain the bootloader firmware
	IWDG	-	The independent watchdog (IWDG) prescaler is configured to its maximum value. It is periodically refreshed to prevent watchdog reset (in case the hardware IWDG option was previously enabled by the user).
	Power	-	The voltage range is [1.8V, 3.6V] In this range: - Flash wait states 3. - System clock Frequency 60 MHz. - ART Accelerator enabled. - Flash write operation by byte (refer to Bootloader Memory Management section for more information).

Table 62. STM32F412xx configuration in system memory boot mode (continued)

Bootloader	Feature/Peripheral	State	Comment
USART1 bootloader	USART1	Enabled	Once initialized the USART1 configuration is: 8-bits, even parity and 1 Stop bit
	USART1_RX pin	Input	PA10 pin: USART1 in reception mode
	USART1_TX pin	Output	PA9 pin: USART1 in transmission mode
USART2 bootloader	USART2	Enabled	Once initialized the USART2 configuration is: 8-bits, even parity and 1 Stop bit
	USART2_RX pin	Input	PD6 pin: USART2 in reception mode
	USART2_TX pin	Output	PD5 pin: USART2 in transmission mode
USART3 bootloader	USART3	Enabled	Once initialized the USART3 configuration is: 8-bits, even parity and 1 Stop bit
	USART3_RX pin	Input	PB11 pin: USART3 in reception mode
	USART3_TX pin	Output	PB10 pin: USART3 in transmission mode
USARTx bootloaders	SysTick timer	Enabled	Used to automatically detect the serial baud rate from the host for USARTx bootloaders.
CAN2 bootloader	CAN2	Enabled	Once initialized the CAN2 configuration is: Baudrate 125 kbps, 11-bit identifier. Note: CAN1 is clocked during CAN2 bootloader execution because CAN1 manages the communication between CAN2 and SRAM.
	CAN2_RX pin	Input	PB5 pin: CAN2 in reception mode
	CAN2_TX pin	Output	PB13 pin: CAN2 in transmission mode
I2C1 bootloader	I2C1	Enabled	The I2C1 configuration is: I2C speed: up to 400 KHz, 7-bit address, slave mode, analog filter ON. Slave 7-bit address: 0b1000110x (where x = 0 for write and x = 1 for read)
	I2C1_SCL pin	Input/Output	PB6 pin: clock line is used in open-drain mode.
	I2C1_SDA pin	Input/Output	PB7 pin: data line is used in open-drain mode.
I2C2 bootloader	I2C2	Enabled	The I2C2 configuration is: I2C speed: up to 400 KHz, 7-bit address, slave mode, analog filter ON. Slave 7-bit address: 0b1000110x (where x = 0 for write and x = 1 for read)
	I2C2_SCL pin	Input/Output	PF1 pin: clock line is used in open-drain mode.
	I2C2_SDA pin	Input/Output	PF0 pin: data line is used in open-drain mode.

Table 62. STM32F412xx configuration in system memory boot mode (continued)

Bootloader	Feature/Peripheral	State	Comment
I2C3 bootloader	I2C3	Enabled	The I2C3 configuration is: I2C speed: up to 400 KHz, 7-bit address, slave mode, analog filter ON. Slave 7-bit address: 0b1000110x (where x = 0 for write and x = 1 for read)
	I2C3_SCL pin	Input/Output	PA8 pin: clock line is used in open-drain mode.
	I2C3_SDA pin	Input/Output	PB4 pin: data line is used in open-drain mode.
I2C4 bootloader	I2C4	Enabled	The I2C4 configuration is: I2C speed: up to 1 MHz, 7-bit address, slave mode, analog filter ON. Slave 7-bit address: 0b1000110x (where x = 0 for write and x = 1 for read)
	I2C4_SCL pin	Input/Output	PB15 pin: clock line is used in open-drain mode.
	I2C4_SDA pin	Input/Output	PB14 pin: data line is used in open-drain mode.
SPI1 bootloader	SPI1	Enabled	The SPI1 configuration is: Slave mode, Full Duplex, 8-bit MSB, Speed up to 8MHz, Polarity: CPOL Low, CPHA Low, NSS hardware.
	SPI1_MOSI pin	Input	PA7 pin: Slave data Input line, used in Push-pull pull-down mode
	SPI1_MISO pin	Output	PA6 pin: Slave data output line, used in Push-pull pull-down mode
	SPI1_SCK pin	Input	PA5 pin: Slave clock line, used in Push-pull pull-down mode
	SPI1_NSS pin	Input	PA4 pin: Slave Chip Select pin used in Push-pull pull-up mode.
SPI3 bootloader	SPI3	Enabled	The SPI3 configuration is: Slave mode, Full Duplex, 8-bit MSB, Speed up to 8MHz, Polarity: CPOL Low, CPHA Low, NSS hardware.
	SPI3_MOSI pin	Input	PC12 pin: Slave data Input line, used in Push-pull pull-down mode
	SPI3_MISO pin	Output	PC11 pin: Slave data output line, used in Push-pull pull-down mode
	SPI3_SCK pin	Input	PC10 pin: Slave clock line, used in Push-pull pull-down mode
	SPI3_NSS pin	Input	PA15 pin: Slave Chip Select pin used in Push-pull pull-up mode.

Table 62. STM32F412xx configuration in system memory boot mode (continued)

Bootloader	Feature/Peripheral	State	Comment
SPI4 bootloader	SPI4	Enabled	The SPI4 configuration is: Slave mode, Full Duplex, 8-bit MSB, Speed up to 8MHz, Polarity: CPOL Low, CPHA Low, NSS hardware.
	SPI4_MOSI pin	Input	PE14 pin: Slave data Input line, used in Push-pull pull-down mode
	SPI4_MISO pin	Output	PE13 pin: Slave data output line, used in Push-pull pull-down mode
	SP4_SCK pin	Input	PE12 pin: Slave clock line, used in Push-pull pull-down mode
	SPI4_NSS pin	Input	PE11 pin: Slave Chip Select pin used in Push-pull pull-up mode.
DFU bootloader	USB	Enabled	USB OTG FS configured in Forced Device mode
	USB_DM pin	Input/Output	PA11 pin: USB DM line.
	USB_DP pin		PA12 pin: USB DP line No external Pull-Up resistor is required.
CAN2 and DFU bootloaders	TIM11	Enabled	This timer is used to determine the value of the HSE. Once HSE frequency is determined, the system clock is configured to 60 MHz using PLL and HSE.

The system clock is derived from the embedded internal high-speed RC for USARTx and I2Cx bootloaders. This internal clock is also used for CAN and DFU (USB FS Device) but only for the selection phase. An external clock multiple of 1 MHz (between 4 and 26 MHz) is required for CAN and DFU bootloader execution after the selection phase.

30.2 Bootloader selection

The *Figure 34* shows the bootloader selection mechanism.

Figure 34.Bootloader V9.x selection for STM32F412xx

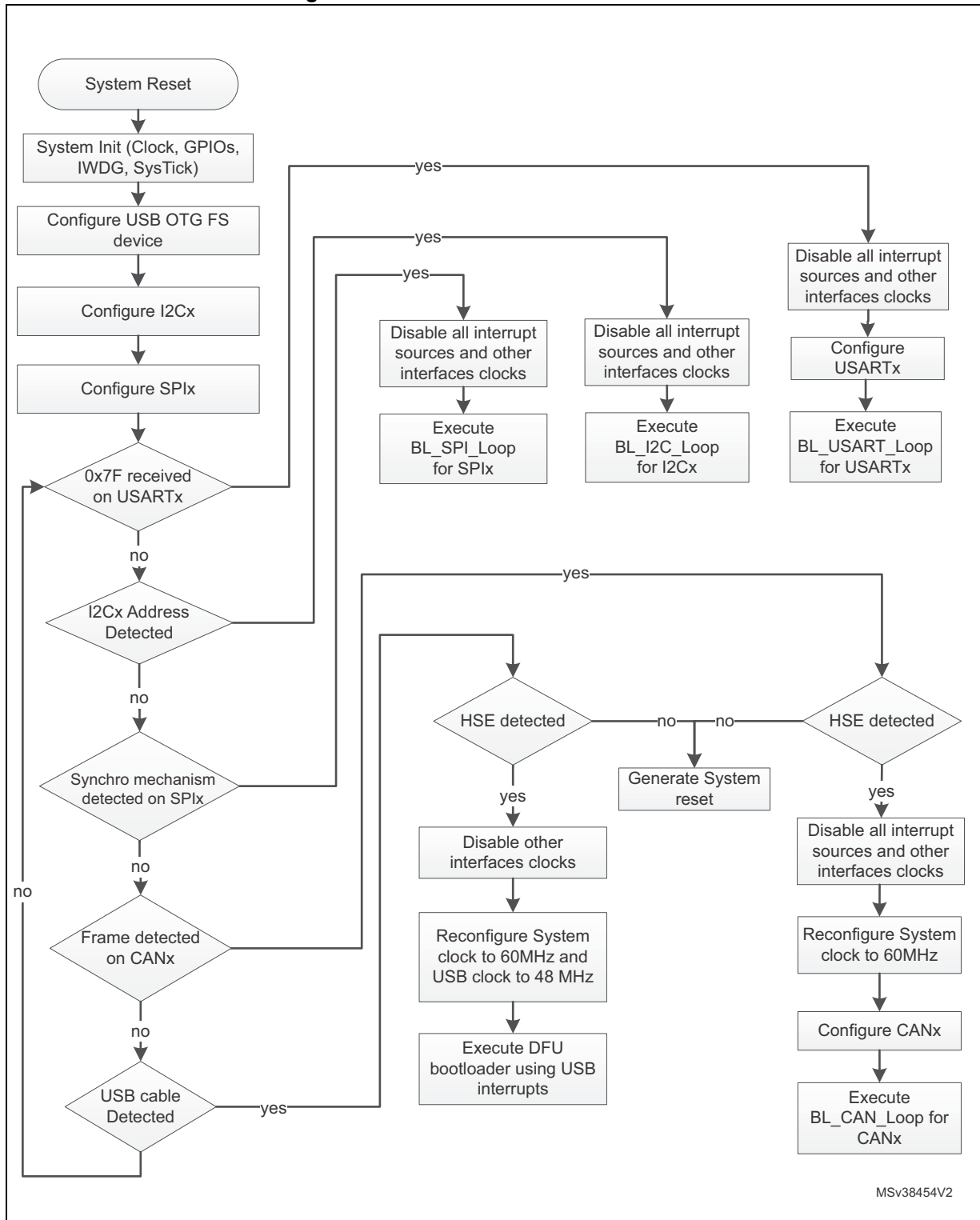

30.3 Bootloader version

The following table lists the STM32F412xx devices bootloader V9.x versions.

Table 63. STM32F412xx bootloader V9.x versions

Bootloader version number	Description	Known limitations
V9.0	Initial bootloader version	None
V9.1	Fix USART3 interface pinout	None

31 STM32F42xxx/43xxx devices bootloader

31.1 Bootloader V7.x

31.1.1 Bootloader configuration

The STM32F42xxx/43xxx bootloader is activated by applying pattern5 (described in [Table 2: Bootloader activation patterns](#)). The following table shows the hardware resources used by this bootloader.

Table 64. STM32F42xxx/43xxx configuration in system memory boot mode

Bootloader	Feature/Peripheral	State	Comment
Common to all bootloaders	RCC	HSI enabled	The system clock frequency is 24 MHz using the PLL. The HSI clock source is used at startup (interface detection phase) and when USART or I2C interfaces are selected (once CAN or DFU bootloader is selected, the clock source will be derived from the external crystal).
		HSE enabled	The system clock frequency is 60 MHz. The HSE clock source is used only when the CAN or the DFU (USB FS Device) interfaces are selected. The external clock must provide a frequency multiple of 1 MHz and ranging from 4 MHz to 26 MHz.
		-	The Clock Security System (CSS) interrupt is enabled for the CAN and DFU bootloaders. Any failure (or removal) of the external clock generates system reset.
	RAM	-	8 Kbyte starting from address 0x20000000 are used by the bootloader firmware
	System memory	-	30424 byte starting from address 0x1FFF0000, contain the bootloader firmware
	IWDG	-	The independent watchdog (IWDG) prescaler is configured to its maximum value. It is periodically refreshed to prevent watchdog reset (in case the hardware IWDG option was previously enabled by the user).
	Power	-	Voltage range is set to [1.62 V, 2.1 V]. In this range internal Flash write operations are allowed only in byte format (Half-Word, Word and Double-Word operations are not allowed). The voltage range can be configured in run time using bootloader commands.

Table 64. STM32F42xxx/43xxx configuration in system memory boot mode (continued)

Bootloader	Feature/Peripheral	State	Comment
USART1 bootloader	USART1	Enabled	Once initialized the USART1 configuration is: 8 bits, even parity and 1 Stop bit
	USART1_RX pin	Input	PA10 pin: USART1 in reception mode
	USART1_TX pin	Output	PA9 pin: USART1 in transmission mode
USART3 bootloader (on PB10/PB11)	USART3	Enabled	Once initialized the USART3 configuration is: 8 bits, even parity and 1 Stop bit
	USART3_RX pin	Input	PB11 pin: USART3 in reception mode
	USART3_TX pin	Output	PB10 pin: USART3 in transmission mode
USART3 bootloader (on PC10/PC11)	USART3	Enabled	Once initialized the USART3 configuration is: 8 bits, even parity and 1 Stop bit
	USART3_RX pin	Input	PC11 pin: USART3 in reception mode
	USART3_TX pin	Output	PC10 pin: USART3 in transmission mode
USARTx bootloaders	SysTick timer	Enabled	Used to automatically detect the serial baud rate from the host for USARTx bootloaders.
CAN2 bootloader	CAN2	Enabled	Once initialized the CAN2 configuration is: Baudrate 125 kbps, 11-bit identifier. Note: CAN1 is clocked during CAN2 bootloader execution because CAN1 manages the communication between CAN2 and SRAM.
	CAN2_RX pin	Input	PB5 pin: CAN2 in reception mode
	CAN2_TX pin	Output	PB13 pin: CAN2 in transmission mode
I2C1 bootloader	I2C1	Enabled	The I2C1 configuration is: I2C speed: up to 400 KHz, 7-bit address, slave mode, analog filter ON. Slave 7-bit address: 0b0111000x (where x = 0 for write and x = 1 for read).
	I2C1_SCL pin	Input/Output	PB6 pin: clock line is used in open-drain mode.
	I2C1_SDA pin	Input/Output	PB9 pin: data line is used in open-drain mode.
DFU bootloader	USB	Enabled	USB OTG FS configured in Forced Device mode
	USB_DM pin	Input/Output	PA11: USB DM line.
	USB_DP pin		PA12: USB DP line No external Pull-up resistor is required
CAN2 and DFU bootloaders	TIM11	Enabled	This timer is used to determine the value of the HSE. Once the HSE frequency is determined, the system clock is configured to 60 MHz using PLL and HSE.

The system clock is derived from the embedded internal high-speed RC for USARTx and I2Cx bootloaders. This internal clock is also used for CAN and DFU (USB FS Device) but only for the selection phase. An external clock multiple of 1 MHz (between 4 and 26 MHz) is required for CAN and DFU bootloader execution after the selection phase.

31.1.2 Bootloader selection

The [Figure 35](#) and [Figure 36](#) show the bootloader selection mechanism.

Figure 35. Dual Bank Boot Implementation for STM32F42xxx/43xxx Bootloader V7.x

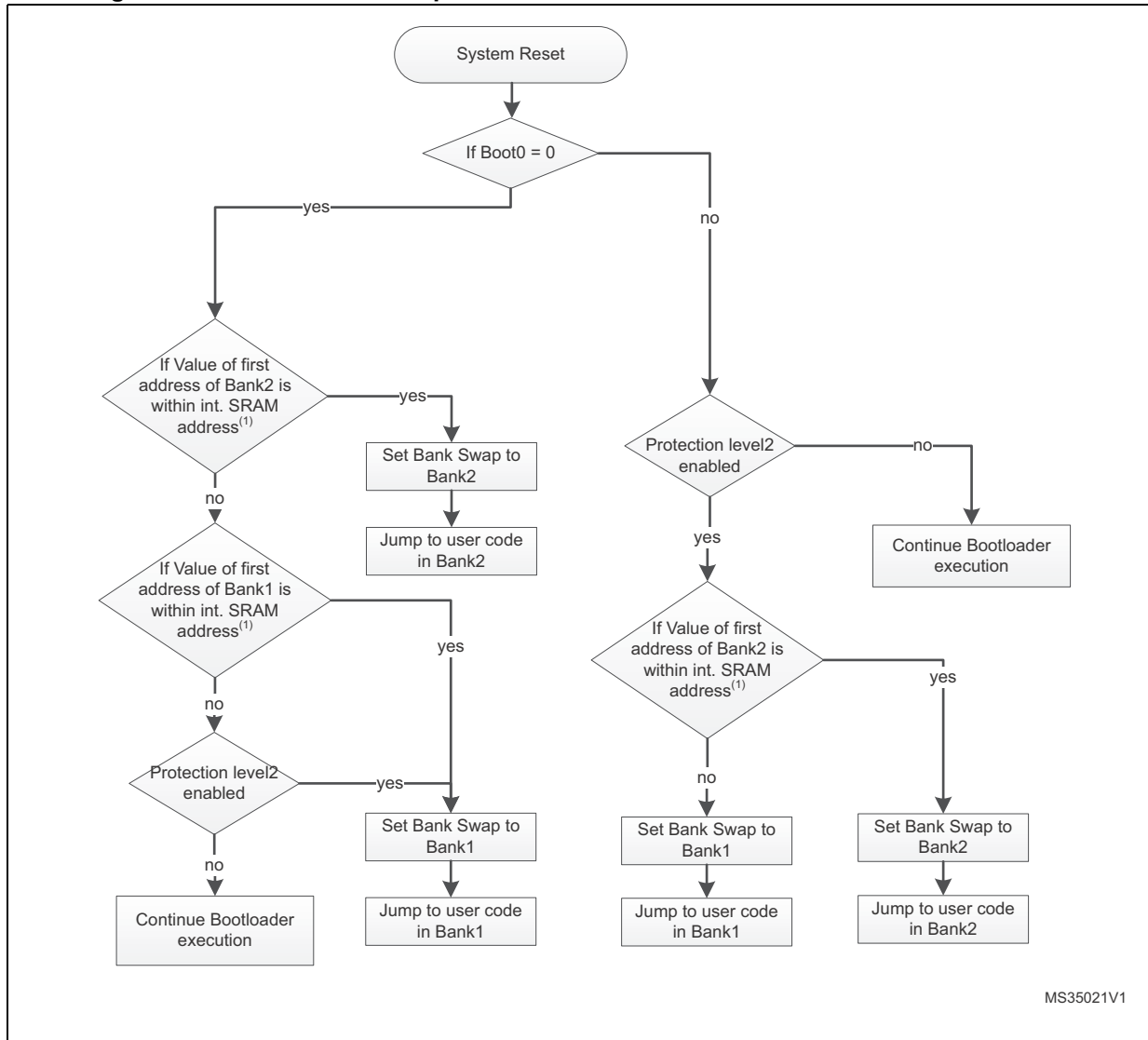

1. CCM RAM is not considered valid as stack pointer address for the dual bank boot mechanism.

Figure 36. Bootloader V7.x selection for STM32F42xxx/43xxx

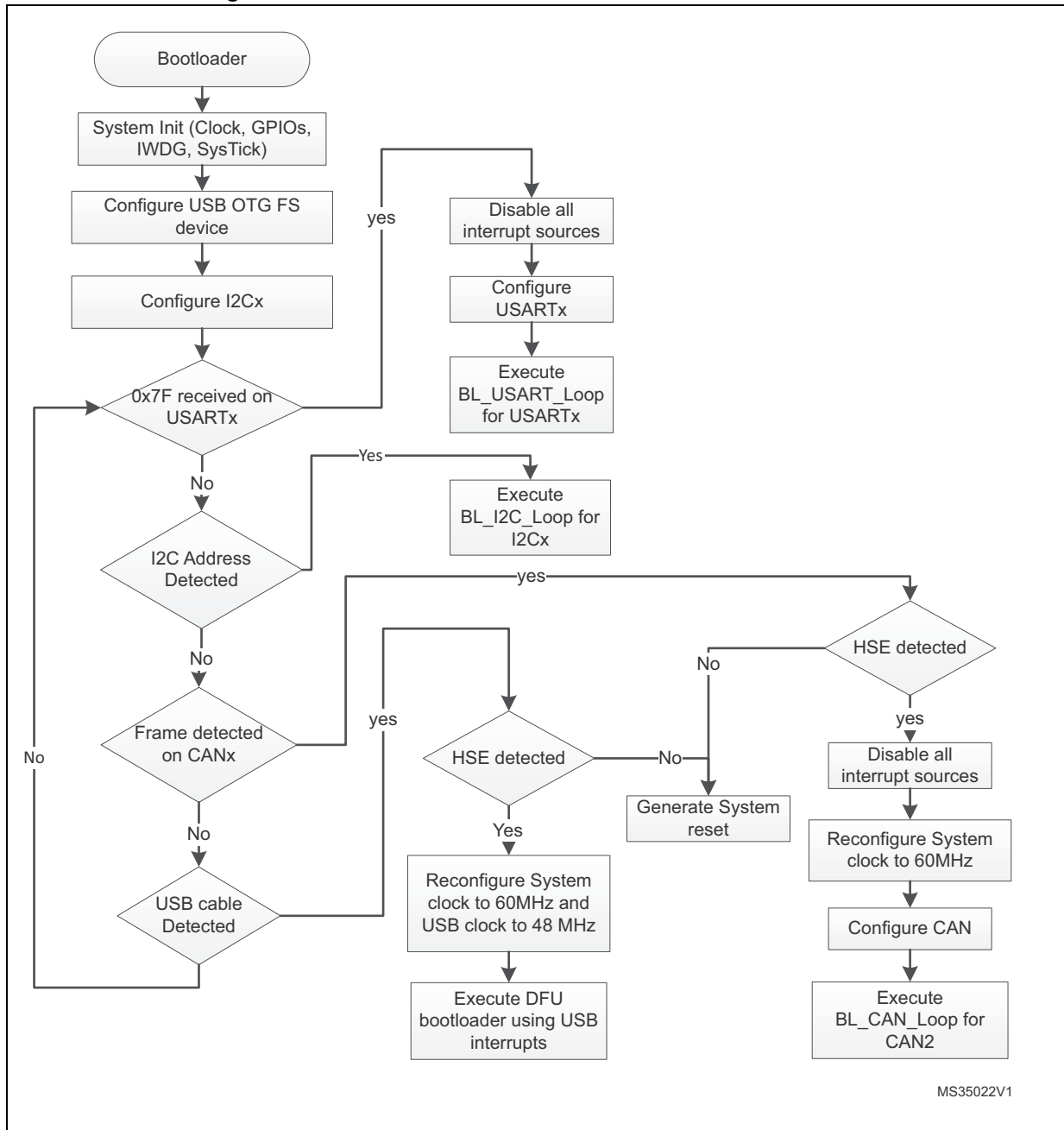

MS35022V1

31.1.3 Bootloader version

The following table lists the STM32F42xxx/43xxx devices bootloader V7.x versions.

Table 65. STM32F42xxx/43xxx bootloader V7.x versions

Bootloader version number	Description	Known limitations
V7.0	Initial bootloader version	For the CAN interface, the Write Unprotect command is not functional. Instead you can use Write Memory command and write directly to the option bytes in order to disable the write protection.

31.2 Bootloader V9.x

31.2.1 Bootloader configuration

The STM32F42xxx/43xxx bootloader is activated by applying pattern5 (described in [Table 2: Bootloader activation patterns](#)). The following table shows the hardware resources used by this bootloader.

Table 66. STM32F42xxx/43xxx configuration in system memory boot mode

Bootloader	Feature/Peripheral	State	Comment
Common to all bootloaders	RCC	HSI enabled	The system clock frequency is 60 MHz using the PLL. The HSI clock source is used at startup (interface detection phase) and when USART or SPI or I2C interfaces are selected (once CAN or DFU bootloader is selected, the clock source will be derived from the external crystal).
		HSE enabled	The system clock frequency is 60 MHz. The HSE clock source is used only when the CAN or the DFU (USB FS Device) interfaces are selected. The external clock must provide a frequency multiple of 1 MHz and ranging from 4 MHz to 26 MHz.
		-	The Clock Security System (CSS) interrupt is enabled for the CAN and DFU bootloaders. Any failure (or removal) of the external clock generates system reset.
	RAM	-	12 Kbyte starting from address 0x20000000 are used by the bootloader firmware
	System memory	-	30424 byte starting from address 0x1FFF0000, contain the bootloader firmware
	IWDG	-	The independent watchdog (IWDG) prescaler is configured to its maximum value. It is periodically refreshed to prevent watchdog reset (in case the hardware IWDG option was previously enabled by the user).
	Power	-	Voltage range is set to [1.62 V, 2.1 V]. In this range internal Flash write operations are allowed only in byte format (Half-Word, Word and Double-Word operations are not allowed). The voltage range can be configured in run time using bootloader commands.
USART1 bootloader	USART1	Enabled	Once initialized the USART1 configuration is: 8-bits, even parity and 1 Stop bit
	USART1_RX pin	Input	PA10 pin: USART1 in reception mode
	USART1_TX pin	Output	PA9 pin: USART1 in transmission mode

Table 66. STM32F42xxx/43xxx configuration in system memory boot mode (continued)

Bootloader	Feature/Peripheral	State	Comment
USART3 bootloader (on PB10/PB11)	USART3	Enabled	Once initialized the USART3 configuration is: 8-bits, even parity and 1 Stop bit
	USART3_RX pin	Input	PB11 pin: USART3 in reception mode
	USART3_TX pin	Output	PB10 pin: USART3 in transmission mode
USART3 bootloader (on PC10/PC11)	USART3	Enabled	Once initialized the USART3 configuration is: 8-bits, even parity and 1 Stop bit
	USART3_RX pin	Input	PC11 pin: USART3 in reception mode
	USART3_TX pin	Output	PC10 pin: USART3 in transmission mode
USARTx bootloaders	SysTick timer	Enabled	Used to automatically detect the serial baud rate from the host for USARTx bootloaders.
CAN2 bootloader	CAN2	Enabled	Once initialized the CAN2 configuration is: Baudrate 125 kbps, 11-bit identifier. Note: CAN1 is clocked during CAN2 bootloader execution because CAN1 manages the communication between CAN2 and SRAM.
	CAN2_RX pin	Input	PB5 pin: CAN2 in reception mode
	CAN2_TX pin	Output	PB13 pin: CAN2 in transmission mode
I2C1 bootloader	I2C1	Enabled	The I2C1 configuration is: I2C speed: up to 400 KHz, 7-bit address, slave mode, analog filter ON. Slave 7-bit address: 0b0111000x (where x = 0 for write and x = 1 for read).
	I2C1_SCL pin	Input/Output	PB6 pin: clock line is used in open-drain mode.
	I2C1_SDA pin	Input/Output	PB9 pin: data line is used in open-drain mode.
I2C2 bootloader	I2C2	Enabled	The I2C2 configuration is: I2C speed: up to 400 KHz, 7-bit address, slave mode, analog filter ON. Slave 7-bit address: 0b0111000x (where x = 0 for write and x = 1 for read).
	I2C2_SCL pin	Input/Output	PF1 pin: clock line is used in open-drain mode.
	I2C2_SDA pin	Input/Output	PF0 pin: data line is used in open-drain mode.
I2C3 bootloader	I2C3	Enabled	The I2C3 configuration is: I2C speed: up to 400 KHz, 7-bit address, slave mode, analog filter ON. Slave 7-bit address: 0b0111000x (where x = 0 for write and x = 1 for read).
	I2C3_SCL pin	Input/Output	PA8 pin: clock line is used in open-drain mode.
	I2C3_SDA pin	Input/Output	PC9 pin: data line is used in open-drain mode.

Table 66. STM32F42xxx/43xxx configuration in system memory boot mode (continued)

Bootloader	Feature/Peripheral	State	Comment
SPI1 bootloader	SPI1	Enabled	The SPI1 configuration is: Slave mode, Full Duplex, -bit MSB, Speed up to 8 MHz, Polarity: CPOL Low, CPHA Low, NSS hardware.
	SPI1_MOSI pin	Input	PA7 pin: Slave data Input line, used in Push-pull pull-down mode
	SPI1_MISO pin	Output	PA6 pin: Slave data output line, used in Push-pull pull-down mode
	SPI1_SCK pin	Input	PA5 pin: Slave clock line, used in Push-pull pull-down mode
	SPI1_NSS pin	Input	PA4 pin: Slave Chip Select pin used in Push-pull pull-down mode.
SPI2 bootloader	SPI2	Enabled	The SPI2 configuration is: Slave mode, Full Duplex, 8-bit MSB, Speed up to 8 MHz, Polarity: CPOL Low, CPHA Low, NSS hardware.
	SPI2_MOSI pin	Input	PI3 pin: Slave data Input line, used in Push-pull pull-down mode
	SPI2_MISO pin	Output	PI2 pin: Slave data output line, used in Push-pull pull-down mode
	SPI2_SCK pin	Input	PI1 pin: Slave clock line, used in Push-pull pull-down mode
	SPI2_NSS pin	Input	PI0 pin: Slave Chip Select pin used in Push-pull pull-down mode.
SPI4 bootloader	SPI4	Enabled	The SPI4 configuration is: Slave mode, Full Duplex, 8-bit MSB, Speed up to 8 MHz, Polarity: CPOL Low, CPHA Low, NSS hardware.
	SPI4_MOSI pin	Input	PE14 pin: Slave data Input line, used in Push-pull pull-down mode
	SPI4_MISO pin	Output	PE13 pin: Slave data output line, used in Push-pull pull-down mode
	SP4_SCK pin	Input	PE12 pin: Slave clock line, used in Push-pull pull-down mode
	SPI4_NSS pin	Input	PE11 pin: Slave Chip Select pin used in Push-pull pull-down mode.
DFU bootloader	USB	Enabled	USB OTG FS configured in Forced Device mode
	USB_DM pin	Input/Output	PA11: USB DM line.
	USB_DP pin		PA12: USB DP line No external Pull-up resistor is required
CAN2 and DFU bootloaders	TIM11	Enabled	This timer is used to determine the value of the HSE. Once the HSE frequency is determined, the system clock is configured to 60 MHz using PLL and HSE.

The system clock is derived from the embedded internal high-speed RC for USARTx, I2Cx and SPIx bootloaders. This internal clock is also used for CAN and DFU (USB FS Device) but only for the selection phase. An external clock multiple of 1 MHz (between 4 and 26 MHz) is required for CAN and DFU bootloader execution after the selection phase.

31.2.2 Bootloader selection

The [Figure 37](#) and [Figure 38](#) show the bootloader selection mechanism.

Figure 37. Dual Bank Boot Implementation for STM32F42xxx/43xxx Bootloader V9.x

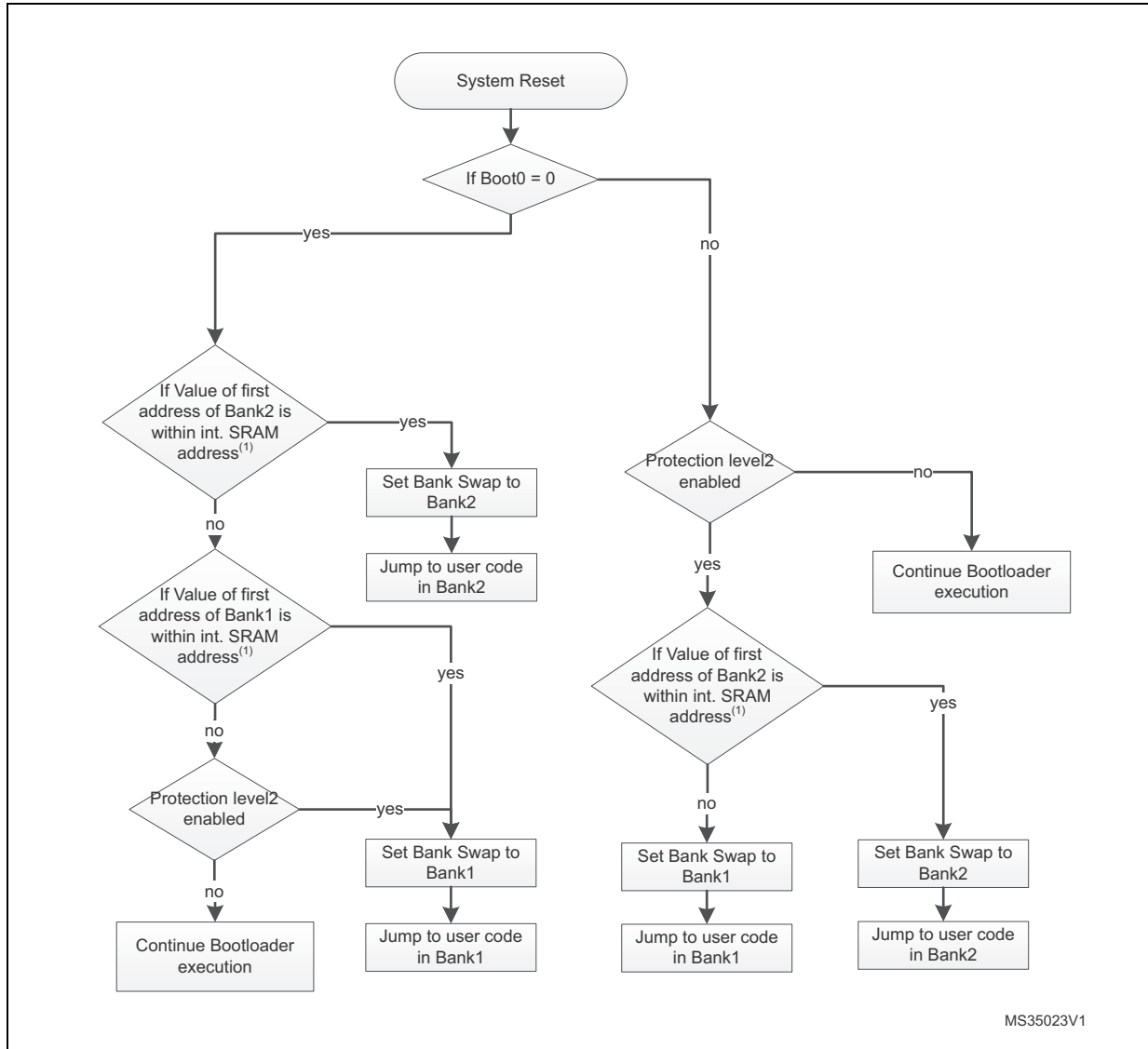

1. CCM RAM is not considered valid as stack pointer address for the dual bank boot mechanism.

Figure 38. Bootloader V9.x selection for STM32F42xxx/43xxx

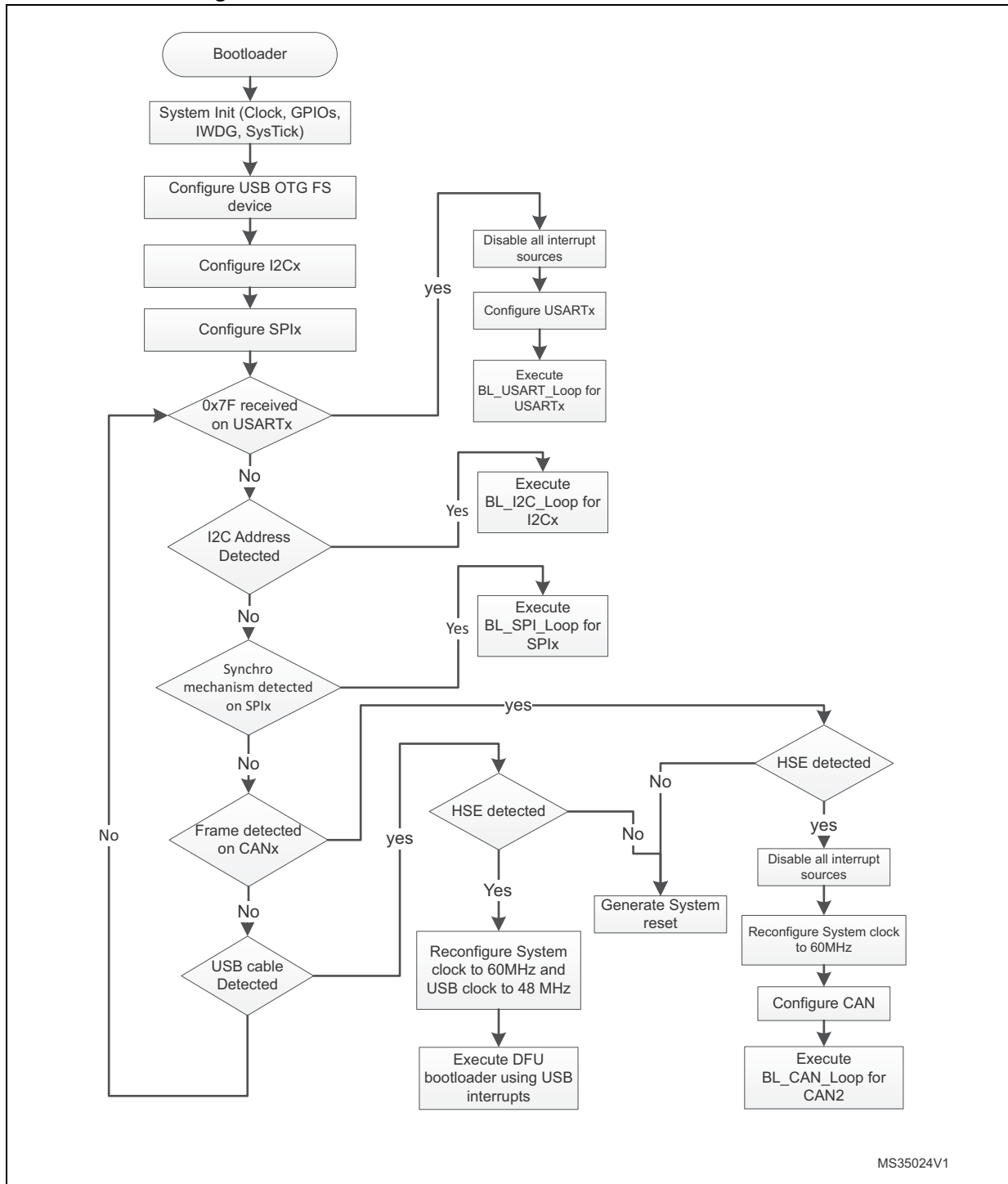

31.2.3 Bootloader version

The following table lists the STM32F42xxx/43xxx devices bootloader V9.x versions.

Table 67. STM32F42xxx/43xxx bootloader V9.x versions

Bootloader version number	Description	Known limitations
V9.0	This bootloader is an updated version of Bootloader v7.0. This new version of bootloader supports I2C2, I2C3, SPI1, SPI2 and SPI4 interfaces. The RAM used by this bootloader is increased from 8Kb to 12Kb. The ID of this bootloader is 0x90. The connection time is increased.	None
V9.1	This bootloader is an updated version of Bootloader v9.0. This new version implements the new I2C No-stretch commands (I2C protocol v1.1) and the capability of disabling PcROP when RDP1 is enabled with ReadOutUnprotect command for all protocols(USB, USART, CAN, I2C and SPI). The ID of this bootloader is 0x91.	For the CAN interface, the Write Unprotect command is not functional. Instead you can use Write Memory command and write directly to the option bytes in order to disable the write protection.

32 STM32F446xx devices bootloader

32.1 Bootloader configuration

The STM32F446xx bootloader is activated by applying pattern1 (described in [Table 2: Bootloader activation patterns](#)). The following table shows the hardware resources used by this bootloader.

Table 68. STM32F446xx configuration in system memory boot mode

Bootloader	Feature/Peripheral	State	Comment
Common to all bootloaders	RCC	HSI enabled	The HSI is used at startup as clock source for system clock configured to 60 MHz and for USART, I2C and SPI bootloader operation.
		HSE enabled	The HSE is used only when the CAN or the DFU (USB FS Device) interfaces are selected. In this case the system clock configured to 60 MHz with HSE as clock source. The HSE frequency must be multiple of 1 MHz and ranging from 4 MHz to 26 MHz.
		-	The Clock Security System (CSS) interrupt is enabled for the CAN and DFU bootloaders. Any failure (or removal) of the external clock generates system reset.
	RAM	-	12 Kbyte starting from address 0x20000000 are used by the bootloader firmware
	System memory	-	30424 byte starting from address 0x1FFF0000, contain the bootloader firmware
	IWDG	-	The independent watchdog (IWDG) prescaler is configured to its maximum value. It is periodically refreshed to prevent watchdog reset (in case the hardware IWDG option was previously enabled by the user).
	Power	-	The voltage range is [1.71 V, 3.6 V]. In this range: - Flash wait states 3. - System Clock 60 MHz. - Prefetch disabled. - Flash write operation by byte (refer to section Bootloader Memory Management for more information).

Table 68. STM32F446xx configuration in system memory boot mode (continued)

Bootloader	Feature/Peripheral	State	Comment
USART1 bootloader	USART1	Enabled	Once initialized the USART1 configuration is: 8-bits, even parity and 1 Stop bit
	USART1_RX pin	Input	PA10 pin: USART1 in reception mode
	USART1_TX pin	Output	PA9 pin: USART1 in transmission mode
USART3 bootloader (on PB10/PB11)	USART3	Enabled	Once initialized the USART3 configuration is: 8-bits, even parity and 1 Stop bit
	USART3_RX pin	Input	PB11 pin: USART3 in reception mode
	USART3_TX pin	Output	PB10 pin: USART3 in transmission mode
USART3 bootloader (on PC10/PC11)	USART3	Enabled	Once initialized the USART3 configuration is: 8-bits, even parity and 1 Stop bit
	USART3_RX pin	Input	PC11 pin: USART3 in reception mode
	USART3_TX pin	Output	PC10 pin: USART3 in transmission mode
USARTx bootloaders	SysTick timer	Enabled	Used to automatically detect the serial baud rate from the host for USARTx bootloaders.
CAN2 bootloader	CAN2	Enabled	Once initialized the CAN2 configuration is: Baudrate 125 kbps, 11-bit identifier. Note: CAN1 is clocked during CAN2 bootloader execution because in CAN1 manages the communication between CAN2 and SRAM.
	CAN2_RX pin	Input	PB5 pin: CAN2 in reception mode
	CAN2_TX pin	Output	PB13 pin: CAN2 in transmission mode
I2C1 bootloader	I2C1	Enabled	The I2C1 configuration is: I2C speed: up to 400 KHz, 7-bit address, slave mode, analog filter ON. Slave 7-bit address: 0b0111100x (where x = 0 for write and x = 1 for read)
	I2C1_SCL pin	Input/Output	PB6 pin: clock line is used in open-drain mode.
	I2C1_SDA pin	Input/Output	PB9 pin: data line is used in open-drain mode.
I2C2 bootloader	I2C2	Enabled	The I2C2 configuration is: I2C speed: up to 400 KHz, 7-bit address, slave mode, analog filter ON. Slave 7-bit address: 0b0111100x (where x = 0 for write and x = 1 for read)
	I2C2_SCL pin	Input/Output	PF1 pin: clock line is used in open-drain mode.
	I2C2_SDA pin	Input/Output	PF0 pin: data line is used in open-drain mode.

Table 68. STM32F446xx configuration in system memory boot mode (continued)

Bootloader	Feature/Peripheral	State	Comment
I2C3 bootloader	I2C3	Enabled	The I2C3 configuration is: I2C speed: up to 400 KHz, 7-bit address, slave mode, analog filter ON. Slave 7-bit address: 0b0111100x (where x = 0 for write and x = 1 for read)
	I2C3_SCL pin	Input/Output	PA8 pin: clock line is used in open-drain mode.
	I2C3_SDA pin	Input/Output	PC9 pin: data line is used in open-drain mode.
SPI1 bootloader	SPI1	Enabled	The SPI1 configuration is: Slave mode, Full Duplex, 8-bit MSB, Speed up to 8 MHz, Polarity: CPOL Low, CPHA Low, NSS hardware.
	SPI1_MOSI pin	Input	PA7 pin: Slave data Input line, used in Push-pull pull-down mode
	SPI1_MISO pin	Output	PA6 pin: Slave data output line, used in Push-pull pull-down mode
	SPI1_SCK pin	Input	PA5 pin: Slave clock line, used in Push-pull pull-down mode
	SPI1_NSS pin	Input	PA4 pin: Slave Chip Select pin used in Push-pull pull-up mode.
SPI2 bootloader	SPI2	Enabled	The SPI2 configuration is: Slave mode, Full Duplex, 8-bit MSB, Speed up to 8 MHz, Polarity: CPOL Low, CPHA Low, NSS hardware.
	SPI2_MOSI pin	Input	PB15 pin: Slave data Input line, used in Push-pull pull-down mode
	SPI2_MISO pin	Output	PB14 pin: Slave data output line, used in Push-pull pull-down mode
	SPI2_SCK pin	Input	PC7 pin: Slave clock line, used in Push-pull pull-down mode
	SPI2_NSS pin	Input	PB12 pin: Slave Chip Select pin used in Push-pull pull-up mode.

Table 68. STM32F446xx configuration in system memory boot mode (continued)

Bootloader	Feature/Peripheral	State	Comment
SPI4 bootloader	SPI4	Enabled	The SPI4 configuration is: Slave mode, Full Duplex, 8-bit MSB, Speed up to 8 MHz, Polarity: CPOL Low, CPHA Low, NSS hardware.
	SPI4_MOSI pin	Input	PE14 pin: Slave data Input line, used in Push-pull pull-down mode
	SPI4_MISO pin	Output	PE13 pin: Slave data output line, used in Push-pull pull-down mode
	SPI4_SCK pin	Input	PE12 pin: Slave clock line, used in Push-pull pull-down mode
	SPI4_NSS pin	Input	PE11 pin: Slave Chip Select pin used in Push-pull pull-up mode.
DFU bootloader	USB	Enabled	USB OTG FS configured in Forced Device mode
	USB_DM pin	Input/Output	PA11: USB DM line.
	USB_DP pin		PA12: USB DP line No external Pull-up resistor is required
CAN2 and DFU bootloaders	TIM17	Enabled	This timer is used to determine the value of the HSE. Once the HSE frequency is determined, the system clock is configured to 60 MHz using PLL and HSE.

The system clock is derived from the embedded internal high-speed RC for USARTx and I2Cx bootloaders. This internal clock is also used for CAN and DFU (USB FS Device) but only for the selection phase. An external clock multiple of 1 MHz (between 4 and 26 MHz) is required for CAN and DFU bootloader execution after the selection phase.

32.2 Bootloader selection

The figure below shows the bootloader selection mechanism.

Figure 39.Bootloader V9.x selection for STM32F446xx

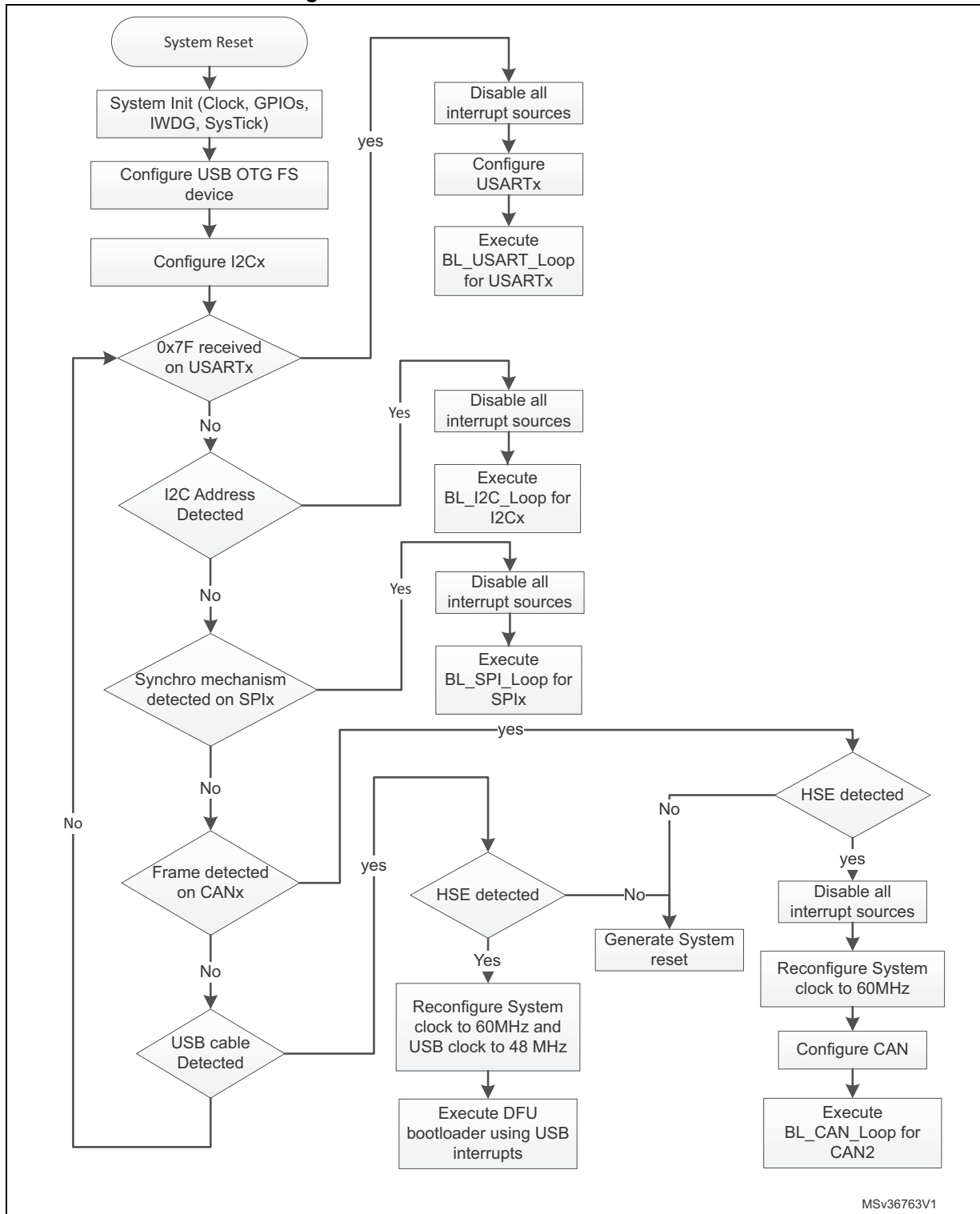

32.3 Bootloader version

The following table lists the STM32F446xx devices bootloader V9.x versions:

Table 69. STM32F446xx bootloader V9.x versions

Bootloader version number	Description	Known limitations
V9.0	Initial bootloader version	None

33 STM32F469xx/479xx devices bootloader

33.1 Bootloader configuration

The STM32F469xx/479xx bootloader is activated by applying pattern5 (described in [Table 2: Bootloader activation patterns](#)). The following table shows the hardware resources used by this bootloader.

Table 70. STM32F469xx/479xx configuration in system memory boot mode

Bootloader	Feature/Peripheral	State	Comment
Common to all bootloaders	RCC	HSI enabled	The system clock frequency is 60 MHz using the PLL. The HSI clock source is used at startup (interface detection phase) and when USART or SPI or I2C interfaces are selected (once CAN or DFU bootloader is selected, the clock source will be derived from external crystal).
		HSE enabled	The system clock frequency is 60 MHz. The HSE clock source is used only when the CAN or the DFU (USB FS Device) interfaces are selected. The external clock must provide a frequency multiple of 1 MHz and ranging from 4 MHz to 26 MHz.
		-	The Clock Security System (CSS) interrupt is enabled for the CAN and DFU bootloaders. Any failure (or removal) of the external clock generates system reset.
	RAM	-	12 Kbyte starting from address 0x20000000 are used by the bootloader firmware
	System memory	-	30431 byte starting from address 0x1FFF0000, contain the bootloader firmware
	IWDG	-	The independent watchdog (IWDG) prescaler is configured to its maximum value. It is periodically refreshed to prevent watchdog reset (in case the hardware IWDG option was previously enabled by the user).
	Power	-	Voltage range is set to [1.62 V, 2.1 V]. In this range internal Flash write operations are allowed only in byte format (Half-Word, Word and Double-Word operations are not allowed). The voltage range can be configured in run time using bootloader commands.

Table 70. STM32F469xx/479xx configuration in system memory boot mode (continued)

Bootloader	Feature/Peripheral	State	Comment
USART1 bootloader	USART1	Enabled	Once initialized the USART1 configuration is: 8-bits, even parity and 1 Stop bit
	USART1_RX pin	Input	PA10 pin: USART1 in reception mode
	USART1_TX pin	Output	PA9 pin: USART1 in transmission mode
USART3 bootloader (on PB10/PB11)	USART3	Enabled	Once initialized the USART3 configuration is: 8-bits, even parity and 1 Stop bit
	USART3_RX pin	Input	PB11 pin: USART3 in reception mode
	USART3_TX pin	Output	PB10 pin: USART3 in transmission mode
USART3 bootloader (on PC10/PC11)	USART3	Enabled	Once initialized the USART3 configuration is: 8-bits, even parity and 1 Stop bit
	USART3_RX pin	Input	PC11 pin: USART3 in reception mode
	USART3_TX pin	Output	PC10 pin: USART3 in transmission mode
USARTx bootloaders	SysTick timer	Enabled	Used to automatically detect the serial baud rate from the host for USARTx bootloaders.
CAN2 bootloader	CAN2	Enabled	Once initialized the CAN2 configuration is: Baudrate 125 kbps, 11-bit identifier. Note: CAN1 is clocked during CAN2 bootloader execution because CAN1 manages the communication between CAN2 and SRAM.
	CAN2_RX pin	Input	PB05 pin: CAN2 in reception mode
	CAN2_TX pin	Output	PB13 pin: CAN2 in transmission mode
I2C1 bootloader	I2C1	Enabled	The I2C1 configuration is: I2C speed: up to 400 KHz, 7-bit address, slave mode, analog filter ON. Slave 7-bit address: 0b1000100x (where x = 0 for write and x = 1 for read).
	I2C1_SCL pin	Input/Output	PB6 pin: clock line is used in open-drain mode.
	I2C1_SDA pin	Input/Output	PB9 pin: data line is used in open-drain mode.
I2C2 bootloader	I2C2	Enabled	The I2C2 configuration is: I2C speed: up to 400 KHz, 7-bit address, slave mode, analog filter ON. Slave 7-bit address: 0b1000100x (where x = 0 for write and x = 1 for read).
	I2C2_SCL pin	Input/Output	PF0 pin: clock line is used in open-drain mode.
	I2C2_SDA pin	Input/Output	PF1 pin: data line is used in open-drain mode.

Table 70. STM32F469xx/479xx configuration in system memory boot mode (continued)

Bootloader	Feature/Peripheral	State	Comment
I2C3 bootloader	I2C3	Enabled	The I2C3 configuration is: I2C speed: up to 400 KHz, 7-bit address, slave mode, analog filter ON. Slave 7-bit address: 0b1000100x (where x = 0 for write and x = 1 for read).
	I2C3_SCL pin	Input/Output	PA8 pin: clock line is used in open-drain mode.
	I2C3_SDA pin	Input/Output	PC9 pin: data line is used in open-drain mode.
SPI1 bootloader	SPI1	Enabled	The SPI1 configuration is: Slave mode, Full Duplex, 8-bit MSB, Speed up to 8 MHz, Polarity: CPOL Low, CPHA Low, NSS hardware.
	SPI1_MOSI pin	Input	PA7 pin: Slave data Input line, used in Push-pull pull-down mode
	SPI1_MISO pin	Output	PA6 pin: Slave data output line, used in Push-pull pull-down mode
	SPI1_SCK pin	Input	PA5 pin: Slave clock line, used in Push-pull pull-down mode
	SPI1_NSS pin	Input	PA4 pin: Slave Chip Select pin used in Push-pull pull-up mode.
SPI2 bootloader	SPI2	Enabled	The SPI2 configuration is: Slave mode, Full Duplex, 8-bit MSB, Speed up to 8 MHz, Polarity: CPOL Low, CPHA Low, NSS hardware.
	SPI2_MOSI pin	Input	PI3 pin: Slave data Input line, used in Push-pull pull-down mode
	SPI2_MISO pin	Output	PI2 pin: Slave data output line, used in Push-pull pull-down mode
	SPI2_SCK pin	Input	PI1 pin: Slave clock line, used in Push-pull pull-down mode
	SPI2_NSS pin	Input	PI0 pin: Slave Chip Select pin used in Push-pull pull-up mode.

Table 70. STM32F469xx/479xx configuration in system memory boot mode (continued)

Bootloader	Feature/Peripheral	State	Comment
SPI4 bootloader	SPI4	Enabled	The SPI4 configuration is: Slave mode, Full Duplex, 8-bit MSB, Speed up to 8 MHz, Polarity: CPOL Low, CPHA Low, NSS hardware.
	SPI4_MOSI pin	Input	PE14 pin: Slave data Input line, used in Push-pull pull-down mode
	SPI4_MISO pin	Output	PE13 pin: Slave data output line, used in Push-pull pull-down mode
	SP4_SCK pin	Input	PE12 pin: Slave clock line, used in Push- pull pull-down mode
	SPI4_NSS pin	Input	PE11 pin: Slave Chip Select pin used in Push-pull pull-up mode.
DFU bootloader	USB	Enabled	USB OTG FS configured in Forced Device mode. USB_OTG_FS interrupt vector is enabled and used for USB DFU communications.
	USB_DM pin	Input/Output	PA11 pin: USB DM line.
	USB_DP pin		PA12 pin: USB DP line. No external Pull-Up resistor is required.

The system clock is derived from the embedded internal high-speed RC for USARTx and I2Cx bootloaders. This internal clock is also used for CAN and DFU (USB FS Device) but only for the selection phase. An external clock multiple of 1 MHz (between 4 and 48 MHz) is required for CAN and DFU bootloaders execution after the selection phase.

33.2 Bootloader selection

The [Figure 40](#) and [Figure 41](#) show the bootloader selection mechanism.

Figure 40. Dual Bank Boot Implementation for STM32F469xx/479xx Bootloader V9.x

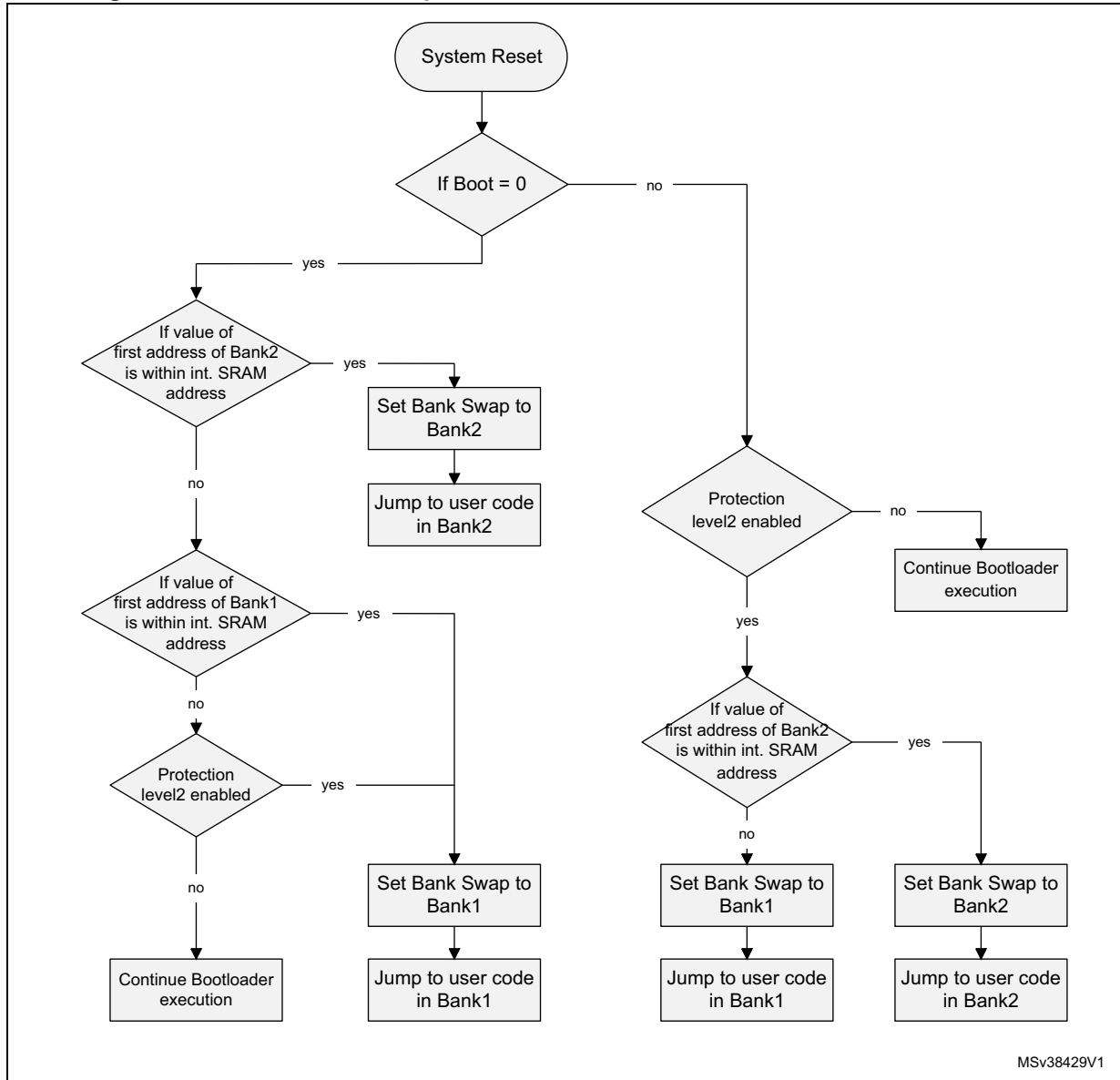

MSv38429V1

Figure 41.Bootloader V9.x selection for STM32F469xx/479xx

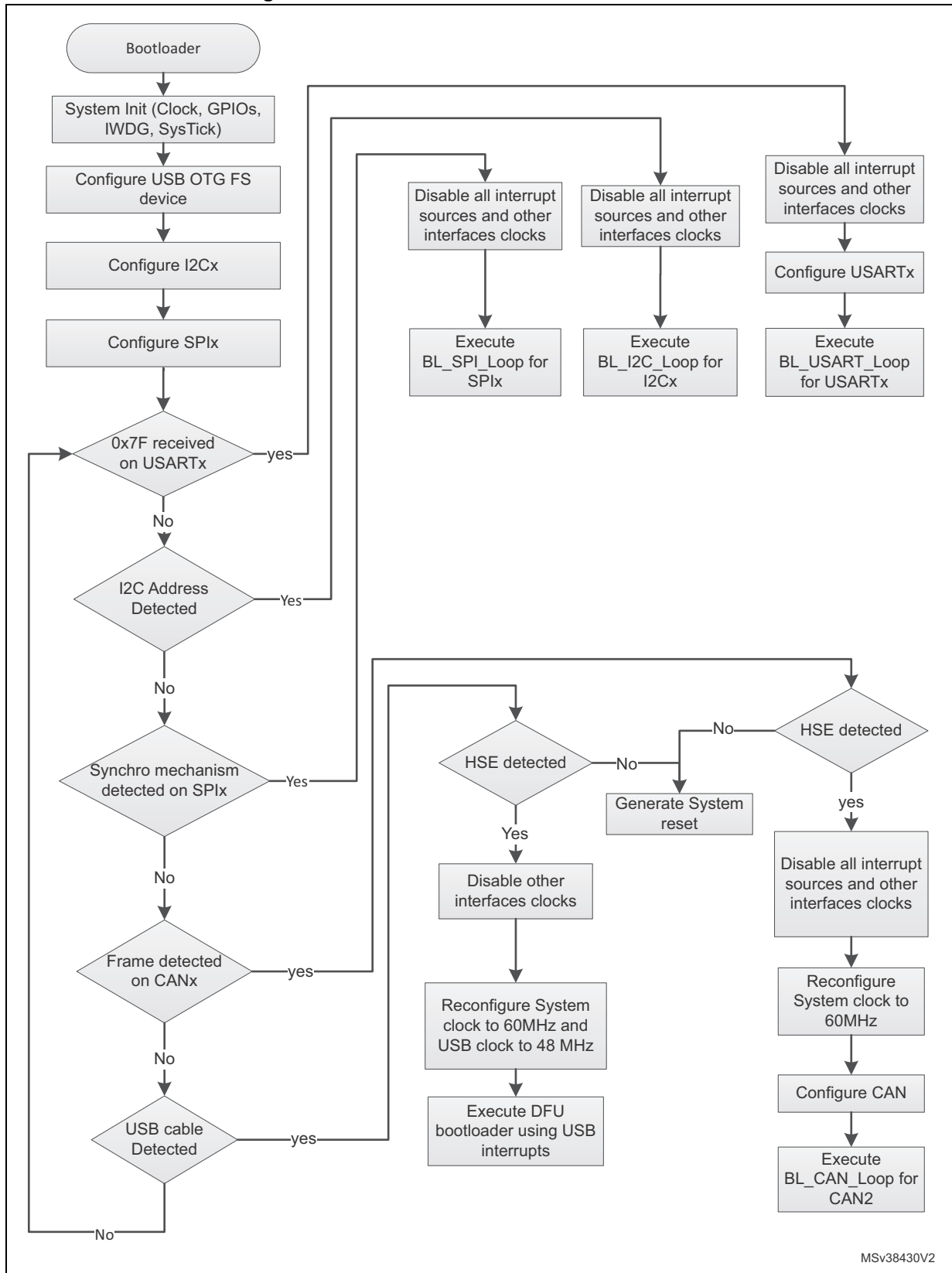

33.3 Bootloader version

The following table lists the STM32F469xx/479xx devices V9.x bootloader versions:

Table 71. STM32F469xx/479xx bootloader V9.x versions

Bootloader version number	Description	Known limitations
V9.0	Initial bootloader version	None

34 STM32F74xxx/75xxx devices bootloader

Two bootloader versions are available on STM32F74xxx/75xxx:

- V7.x supporting USART1, USART3, CAN2, I2C1, I2C2, I2C3 and DFU (USB FS Device). This version is embedded in STM32F74xxx/75xxx rev. A devices.
- V9.x supporting USART1, USART3, CAN2, I2C1, I2C2, I2C3, SPI1, SPI2, SPI4 and DFU (USB FS Device). This version is embedded in STM32F74xxx/75xxx rev. Z devices.

Note: When readout protection Level2 is activated, STM32F74xxx/75xxx devices can boot also on system memory and all commands are not accessible except *Get*, *GetID*, and *GetVersion*.

34.1 Bootloader V7.x

34.1.1 Bootloader configuration

The STM32F74xxx/75xxx bootloader is activated by applying pattern8 (described in [Table 2: Bootloader activation patterns](#)). The following table shows the hardware resources used by this bootloader.

Table 72. STM32F74xxx/75xxx configuration in system memory boot mode

Bootloader	Feature/Peripheral	State	Comment
Common to all bootloaders	RCC	HSI enabled	The HSI is used at startup as clock source for system clock configured to 60 MHz and for USART and I2C bootloader operation.
		HSE enabled	The HSE is used only when the CAN or the DFU (USB FS Device) interfaces are selected. In this case the system clock configured to 60 MHz with HSE as clock source. The HSE frequency must be multiple of 1 MHz and ranging from 4 MHz to 26 MHz.
		-	The Clock Security System (CSS) interrupt is enabled for the CAN and DFU bootloaders. Any failure (or removal) of the external clock generates system reset.
	RAM	-	16 Kbyte starting from address 0x20000000 are used by the bootloader firmware
	System memory	-	61440 byte starting from address 0x1FF00000, contain the bootloader firmware
	IWDG	-	The independent watchdog (IWDG) prescaler is configured to its maximum value. It is periodically refreshed to prevent watchdog reset (in case the hardware IWDG option was previously enabled by the user).
	Power	-	The voltage range is [1.8V, 3.6V]. In this range: - Flash wait states 3. - System clock Frequency 60 MHz. - ART Accelerator enabled. - Flash write operation by byte (refer to Bootloader Memory Management section for more information).
USART1 bootloader	USART1	Enabled	Once initialized the USART1 configuration is: 8-bits, even parity and 1 Stop bit
	USART1_RX pin	Input	PA10 pin: USART1 in reception mode
	USART1_TX pin	Output	PA9 pin: USART1 in transmission mode
USART3 bootloader (on PB10/PB11)	USART3	Enabled	Once initialized the USART3 configuration is: 8-bits, even parity and 1 Stop bit
	USART3_RX pin	Input	PB11 pin: USART3 in reception mode
	USART3_TX pin	Output	PB10 pin: USART3 in transmission mode
USART3 bootloader (on PC10/PC11)	USART3	Enabled	Once initialized the USART3 configuration is: 8-bits, even parity and 1 Stop bit
	USART3_RX pin	Input	PC11 pin: USART3 in reception mode
	USART3_TX pin	Output	PC10 pin: USART3 in transmission mode
USARTx bootloaders	SysTick timer	Enabled	Used to automatically detect the serial baud rate from the host for USARTx bootloaders.

Table 72. STM32F74xxx/75xxx configuration in system memory boot mode (continued)

Bootloader	Feature/Peripheral	State	Comment
CAN2 bootloader	CAN2	Enabled	Once initialized the CAN2 configuration is: Baudrate 125 kbps, 11-bit identifier. Note: CAN1 is clocked during CAN2 bootloader execution because CAN1 manages the communication between CAN2 and SRAM.
	CAN2_RX pin	Input	PB5 pin: CAN2 in reception mode
	CAN2_TX pin	Output	PB13 pin: CAN2 in transmission mode
I2C1 bootloader	I2C1	Enabled	The I2C1 configuration is: I2C speed: up to 400 KHz, 7-bit address, slave mode, analog filter ON. Slave 7-bit address: 0b1000101x (where x = 0 for write and x = 1 for read)
	I2C1_SCL pin	Input/Output	PB6 pin: clock line is used in open-drain mode.
	I2C1_SDA pin	Input/Output	PB9 pin: data line is used in open-drain mode.
I2C2 bootloader	I2C2	Enabled	The I2C2 configuration is: I2C speed: up to 400 KHz, 7-bit address, slave mode, analog filter ON. Slave 7-bit address: 0b1000101x (where x = 0 for write and x = 1 for read)
	I2C2_SCL pin	Input/Output	PF1 pin: clock line is used in open-drain mode.
	I2C2_SDA pin	Input/Output	PF0 pin: data line is used in open-drain mode.
I2C3 bootloader	I2C3	Enabled	The I2C3 configuration is: I2C speed: up to 400 KHz, 7-bit address, slave mode, analog filter ON. Slave 7-bit address: 0b1000101x (where x = 0 for write and x = 1 for read)
	I2C3_SCL pin	Input/Output	PA8 pin: clock line is used in open-drain mode.
	I2C3_SDA pin	Input/Output	PC9 pin: data line is used in open-drain mode.
DFU bootloader	USB	Enabled	USB OTG FS configured in Forced Device mode.
	USB_DM pin	Input/Output	PA11 pin: USB DM line.
	USB_DP pin		PA12 pin: USB DP line No external Pull-Up resistor is required.
CAN2 and DFU bootloaders	TIM11	Enabled	This timer is used to determine the value of the HSE. Once HSE frequency is determined, the system clock is configured to 60 MHz using PLL and HSE.

The system clock is derived from the embedded internal high-speed RC for USARTx and I2Cx bootloaders. This internal clock is also used for CAN and DFU (USB FS Device) but only for the selection phase. An external clock multiple of 1 MHz (between 4 and 26 MHz) is required for CAN and DFU bootloader execution after the selection phase.

34.1.2 Bootloader selection

The figure below shows the bootloader selection mechanism.

Figure 42.Bootloader V7.x selection for STM32F74xxx/75xxx

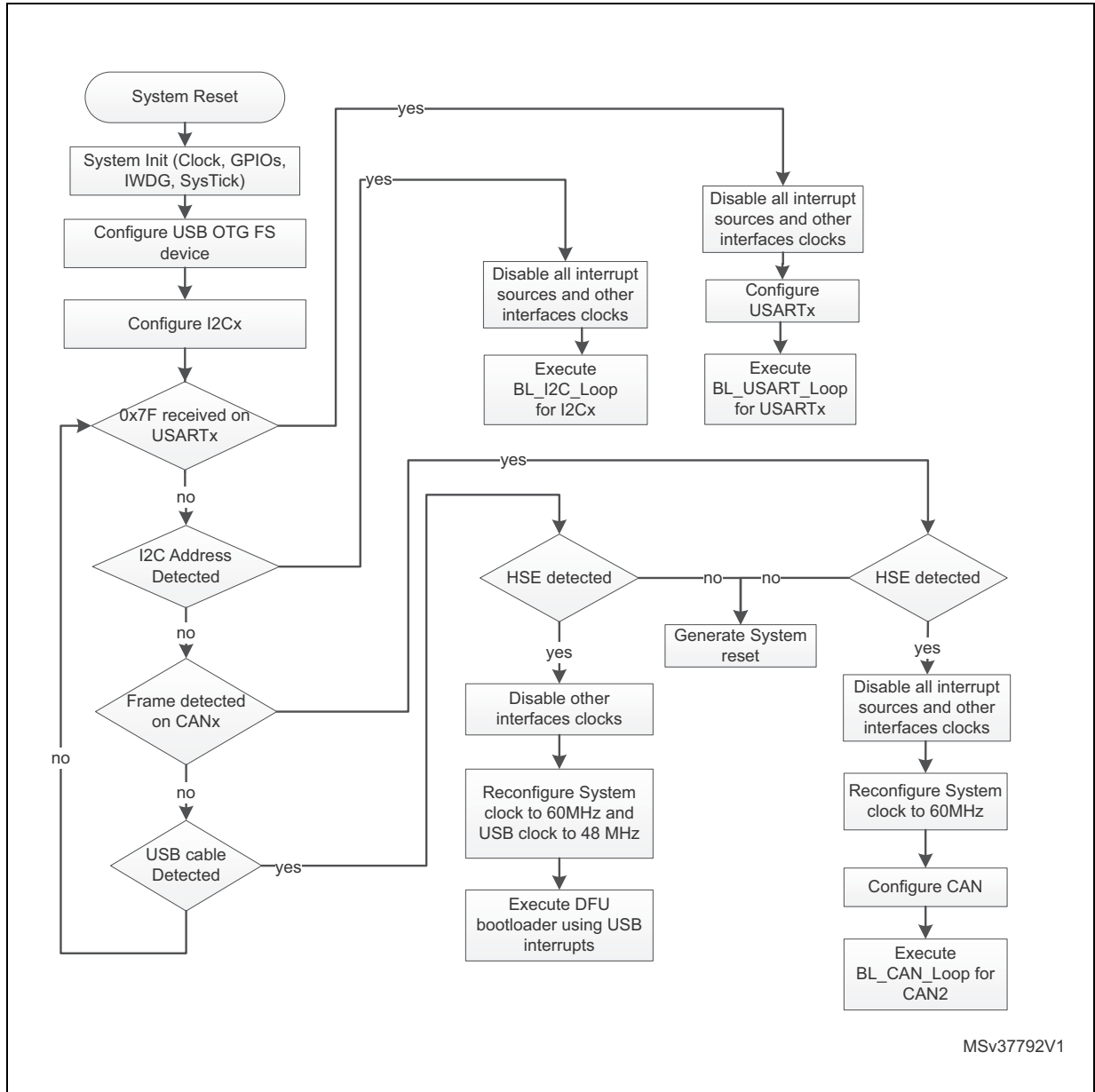

34.1.3 Bootloader version

The following table lists the STM32F74xxx/75xxx devices bootloader V7.x versions:

Table 73. STM32F74xxx/75xxx bootloader V7.x versions

Bootloader version number	Description	Known limitations
V7.0	Initial bootloader version	None

34.2 Bootloader V9.x

34.2.1 Bootloader configuration

The STM32F74xxx/75xxx bootloader is activated by applying pattern8 (described in [Table 2: Bootloader activation patterns](#)). The following table shows the hardware resources used by this bootloader.

Table 74. STM32F74xxx/75xxx configuration in system memory boot mode

Bootloader	Feature/Peripheral	State	Comment
Common to all bootloaders	RCC	HSI enabled	The HSI is used at startup as clock source for system clock configured to 60 MHz and for USART, I2C and SPI bootloader operation.
		HSE enabled	The HSE is used only when the CAN or the DFU (USB FS Device) interfaces are selected. In this case the system clock configured to 60 MHz with HSE as clock source. The HSE frequency must be multiple of 1 MHz and ranging from 4 MHz to 26 MHz.
		-	The Clock Security System (CSS) interrupt is enabled for the CAN and DFU bootloaders. Any failure (or removal) of the external clock generates system reset.
	RAM	-	16 Kbyte starting from address 0x20000000 are used by the bootloader firmware
	System memory	-	61440 byte starting from address 0x1FF00000, contain the bootloader firmware
	IWDG	-	The independent watchdog (IWDG) prescaler is configured to its maximum value. It is periodically refreshed to prevent watchdog reset (in case the hardware IWDG option was previously enabled by the user).
	Power	-	The voltage range is [1.8V, 3.6V] In this range: - Flash wait states 3. - System clock Frequency 60 MHz. - ART Accelerator enabled. - Flash write operation by byte (refer to Bootloader Memory Management section for more information).

Table 74. STM32F74xxx/75xxx configuration in system memory boot mode (continued)

Bootloader	Feature/Peripheral	State	Comment
USART1 bootloader	USART1	Enabled	Once initialized the USART1 configuration is: 8-bits, even parity and 1 Stop bit
	USART1_RX pin	Input	PA10 pin: USART1 in reception mode
	USART1_TX pin	Output	PA9 pin: USART1 in transmission mode
USART3 bootloader (on PB10/PB11)	USART3	Enabled	Once initialized the USART3 configuration is: 8-bits, even parity and 1 Stop bit
	USART3_RX pin	Input	PB11 pin: USART3 in reception mode
	USART3_TX pin	Output	PB10 pin: USART3 in transmission mode
USART3 bootloader (on PC10/PC11)	USART3	Enabled	Once initialized the USART3 configuration is: 8-bits, even parity and 1 Stop bit
	USART3_RX pin	Input	PC11 pin: USART3 in reception mode
	USART3_TX pin	Output	PC10 pin: USART3 in transmission mode
USARTx bootloaders	SysTick timer	Enabled	Used to automatically detect the serial baud rate from the host for USARTx bootloaders.
CAN2 bootloader	CAN2	Enabled	Once initialized the CAN2 configuration is: Baudrate 125 kbps, 11-bit identifier. Note: CAN1 is clocked during CAN2 bootloader execution because CAN1 manages the communication between CAN2 and SRAM.
	CAN2_RX pin	Input	PB5 pin: CAN2 in reception mode
	CAN2_TX pin	Output	PB13 pin: CAN2 in transmission mode
I2C1 bootloader	I2C1	Enabled	The I2C1 configuration is: I2C speed: up to 400 KHz, 7-bit address, slave mode, analog filter ON. Slave 7-bit address: 0b1000101x (where x = 0 for write and x = 1 for read)
	I2C1_SCL pin	Input/output	PB6 pin: clock line is used in open-drain mode.
	I2C1_SDA pin	Input/output	PB9 pin: data line is used in open-drain mode.
I2C2 bootloader	I2C2	Enabled	The I2C2 configuration is: I2C speed: up to 400 KHz, 7-bit address, slave mode, analog filter ON. Slave 7-bit address: 0b1000101x (where x = 0 for write and x = 1 for read)
	I2C2_SCL pin	Input/output	PF1 pin: clock line is used in open-drain mode.
	I2C2_SDA pin	Input/output	PF0 pin: data line is used in open-drain mode.

Table 74. STM32F74xxx/75xxx configuration in system memory boot mode (continued)

Bootloader	Feature/Peripheral	State	Comment
I2C3 bootloader	I2C3	Enabled	The I2C3 configuration is: I2C speed: up to 400 KHz, 7-bit address, slave mode, analog filter ON. Slave 7-bit address: 0b1000101x (where x = 0 for write and x = 1 for read)
	I2C3_SCL pin	Input/output	PA8 pin: clock line is used in open-drain mode.
	I2C3_SDA pin	Input/output	PC9 pin: data line is used in open-drain mode.
SPI1 bootloader	SPI1	Enabled	The SPI1 configuration is: Slave mode, Full Duplex, 8-bit MSB, Speed up to 8 MHz, Polarity: CPOL Low, CPHA Low, NSS hardware.
	SPI1_MOSI pin	Input	PA7 pin: Slave data Input line, used in Push-pull pull-down mode
	SPI1_MISO pin	Output	PA6 pin: Slave data output line, used in Push-pull pull-down mode
	SPI1_SCK pin	Input	PA5 pin: Slave clock line, used in Push-pull pull-down mode
	SPI1_NSS pin	Input	PA4 pin: Slave Chip Select pin used in Push-pull pull-up mode.
SPI2 bootloader	SPI2	Enabled	The SPI2 configuration is: Slave mode, Full Duplex, 8-bit MSB, Speed up to 8 MHz, Polarity: CPOL Low, CPHA Low, NSS hardware.
	SPI2_MOSI pin	Input	PI3 pin: Slave data Input line, used in Push-pull pull-down mode
	SPI2_MISO pin	Output	PI2 pin: Slave data output line, used in Push-pull pull-down mode
	SPI2_SCK pin	Input	PI1 pin: Slave clock line, used in Push-pull pull-down mode
	SPI2_NSS pin	Input	PI0 pin: Slave Chip Select pin used in Push-pull pull-up mode.

Table 74. STM32F74xxx/75xxx configuration in system memory boot mode (continued)

Bootloader	Feature/Peripheral	State	Comment
SPI4 bootloader	SPI4	Enabled	The SPI4 configuration is: Slave mode, Full Duplex, 8-bit MSB, Speed up to 8 MHz, Polarity: CPOL Low, CPHA Low, NSS hardware.
	SPI4_MOSI pin	Input	PE14 pin: Slave data Input line, used in Push-pull pull-down mode
	SPI4_MISO pin	Output	PE13 pin: Slave data output line, used in Push-pull pull-down mode
	SP4_SCK pin	Input	PE12 pin: Slave clock line, used in Push-pull pull-down mode
	SPI4_NSS pin	Input	PE11 pin: Slave Chip Select pin used in Push-pull pull-up mode.
DFU bootloader	USB	Enabled	USB OTG FS configured in Forced Device mode.
	USB_DM pin	Input/Output	PA11 pin: USB DM line.
	USB_DP pin		PA12 pin: USB DP line No external Pull-Up resistor is required.
CAN2 and DFU bootloaders	TIM11	Enabled	This timer is used to determine the value of the HSE. Once HSE frequency is determined, the system clock is configured to 60 MHz using PLL and HSE.

The system clock is derived from the embedded internal high-speed RC for USARTx, I2Cx and SPIx bootloaders. This internal clock is also used for CAN and DFU (USB FS Device) but only for the selection phase. An external clock multiple of 1 MHz (between 4 and 26 MHz) is required for CAN and DFU bootloader execution after the selection phase.

34.2.2 Bootloader selection

The *Figure 43* shows the bootloader selection mechanism.

Figure 43.Bootloader V9.x selection for STM32F74xxx/75xxx

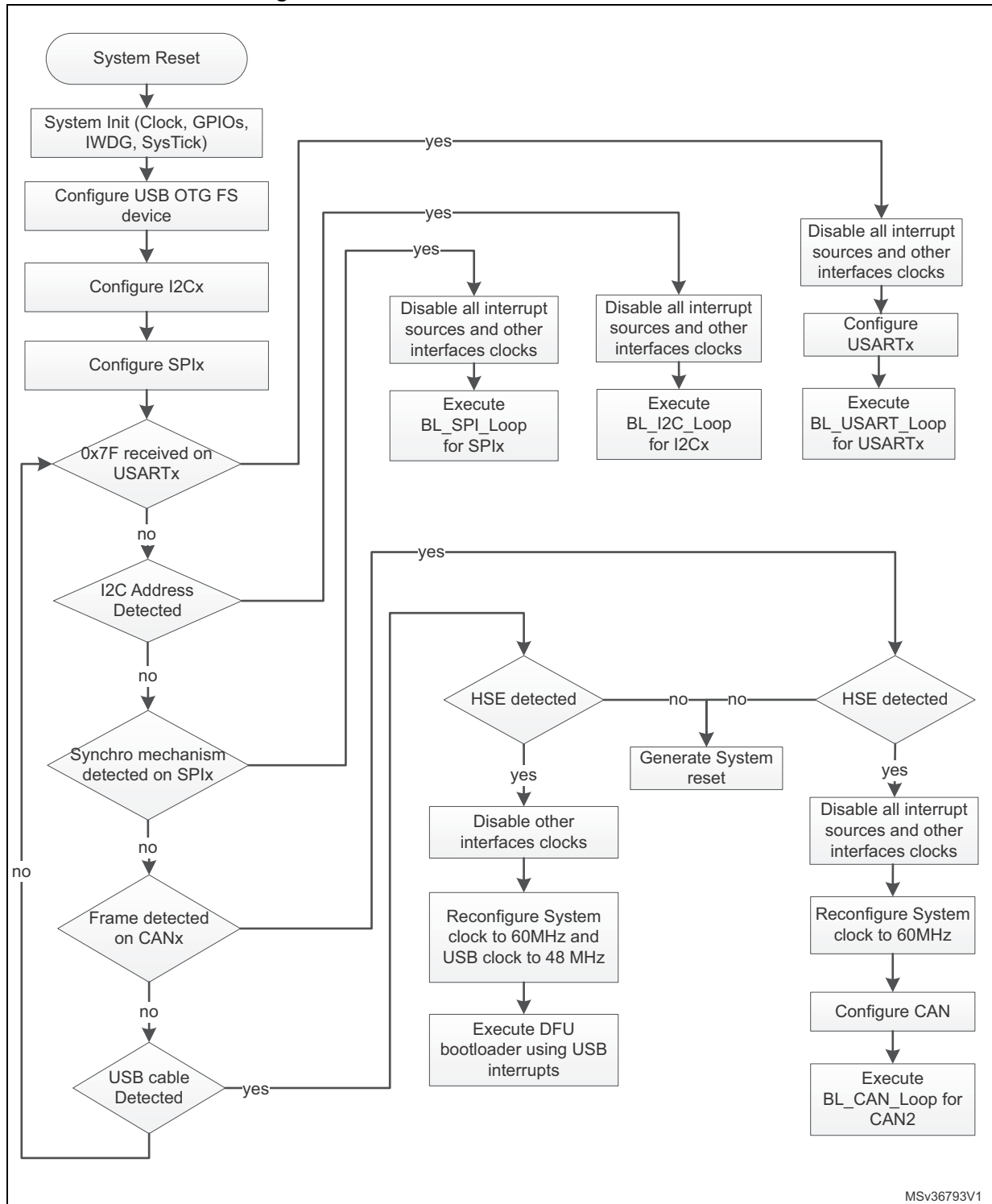

34.2.3 Bootloader version

The following table lists the STM32F74xxx/75xxx bootloader V9.x versions:

Table 75. STM32F74xxx/75xxx bootloader V9.x versions

Bootloader version number	Description	Known limitations
V9.0	Initial bootloader version	None

35 STM32F76xxx/77xxx devices bootloader

35.1 Bootloader configuration

The STM32F76xxx/77xxx bootloader is activated by applying pattern9 (described in [Table 2: Bootloader activation patterns](#)). The following table shows the hardware resources used by this bootloader.

Table 76. STM32F76xxx/77xxx configuration in system memory boot mode

Bootloader	Feature/Peripheral	State	Comment
Common to all bootloaders	RCC	HSI enabled	The HSI is used at startup as clock source for system clock configured to 60 MHz and for USART and I2C bootloader operation.
		HSE enabled	The HSE is used only when the CAN or the DFU (USB FS Device) interfaces are selected. In this case the system clock configured to 60 MHz with HSE as clock source. The HSE frequency must be multiple of 1 MHz and ranging from 4 MHz to 26 MHz.
		-	The Clock Security System (CSS) interrupt is enabled for the CAN and DFU bootloaders. Any failure (or removal) of the external clock generates system reset.
	RAM	-	16 Kbytes starting from address 0x20000000 are used by the bootloader firmware
	System memory	-	60863 bytes starting from address 0x1FF00000, contain the bootloader firmware
	IWDG	-	The independent watchdog (IWDG) prescaler is configured to its maximum value. It is periodically refreshed to prevent watchdog reset (in case the hardware IWDG option was previously enabled by the user).
	Power	-	The voltage range is [1.8V, 3.6V] In this range: - Flash wait states 3. - System clock Frequency 60 MHz. - ART Accelerator enabled. - Flash write operation by byte (refer to Bootloader Memory Management section for more information).

Table 76. STM32F76xxx/77xxx configuration in system memory boot mode (continued)

Bootloader	Feature/Peripheral	State	Comment
USART1 bootloader	USART1	Enabled	Once initialized the USART1 configuration is: 8-bits, even parity and 1 Stop bit
	USART1_RX pin	Input	PA10 pin: USART1 in reception mode
	USART1_TX pin	Output	PA9 pin: USART1 in transmission mode
USART3 bootloader (on PB11/PB10)	USART3	Enabled	Once initialized the USART3 configuration is: 8-bits, even parity and 1 Stop bit
	USART3_RX pin	Input	PB11 pin: USART3 in reception mode
	USART3_TX pin	Output	PB10 pin: USART3 in transmission mode
USART3 bootloader (on PC11/PC10)	USART3	Enabled	Once initialized the USART3 configuration is: 8-bits, even parity and 1 Stop bit
	USART3_RX pin	Input	PC11 pin: USART3 in reception mode
	USART3_TX pin	Output	PC10 pin: USART3 in transmission mode
USARTx bootloaders	SysTick timer	Enabled	Used to automatically detect the serial baud rate from the host for USARTx bootloaders.
CAN2 bootloader	CAN2	Enabled	Once initialized the CAN2 configuration is: Baudrate 125 kbps, 11-bit identifier. Note: CAN1 is clocked during CAN2 bootloader execution because CAN1 manages the communication between CAN2 and SRAM.
	CAN2_RX pin	Input	PB5 pin: CAN2 in reception mode
	CAN2_TX pin	Output	PB13 pin: CAN2 in transmission mode
I2C1 bootloader	I2C1	Enabled	The I2C1 configuration is: I2C speed: up to 400 KHz, 7-bit address, slave mode, analog filter ON. Slave 7-bit address: 0b1001001x (where x = 0 for write and x = 1 for read)
	I2C1_SCL pin	Input/Output	PB6 pin: clock line is used in open-drain mode.
	I2C1_SDA pin	Input/Output	PB9 pin: data line is used in open-drain mode.
I2C2 bootloader	I2C2	Enabled	The I2C2 configuration is: I2C speed: up to 400 KHz, 7-bit address, slave mode, analog filter ON. Slave 7-bit address: 0b1001001x (where x = 0 for write and x = 1 for read)
	I2C2_SCL pin	Input/Output	PF1 pin: clock line is used in open-drain mode.
	I2C2_SDA pin	Input/Output	PF0 pin: data line is used in open-drain mode.

Table 76. STM32F76xxx/77xxx configuration in system memory boot mode (continued)

Bootloader	Feature/Peripheral	State	Comment
I2C3 bootloader	I2C3	Enabled	The I2C3 configuration is: I2C speed: up to 400 KHz, 7-bit address, slave mode, analog filter ON. Slave 7-bit address: 0b1001001x (where x = 0 for write and x = 1 for read)
	I2C3_SCL pin	Input/Output	PA8 pin: clock line is used in open-drain mode.
	I2C3_SDA pin	Input/Output	PC9 pin: data line is used in open-drain mode.
SPI1 bootloader	SPI1	Enabled	The SPI1 configuration is: Slave mode, Full Duplex, 8-bit MSB, Speed up to 8MHz, Polarity: CPOL Low, CPHA Low, NSS hardware.
	SPI1_MOSI pin	Input	PA7 pin: Slave data Input line, used in Push-pull pull-down mode
	SPI1_MISO pin	Output	PA6 pin: Slave data output line, used in Push-pull pull-down mode
	SPI1_SCK pin	Input	PA5 pin: Slave clock line, used in Push-pull pull-down mode
	SPI1_NSS pin	Input	PA4 pin: Slave Chip Select pin used in Push-pull pull-up mode.
SPI2 bootloader	SPI2	Enabled	The SPI2 configuration is: Slave mode, Full Duplex, 8-bit MSB, Speed up to 8MHz, Polarity: CPOL Low, CPHA Low, NSS hardware.
	SPI2_MOSI pin	Input	PI3 pin: Slave data Input line, used in Push-pull pull-down mode
	SPI2_MISO pin	Output	PI2 pin: Slave data output line, used in Push-pull pull-down mode
	SPI2_SCK pin	Input	PI1 pin: Slave clock line, used in Push-pull pull-down mode
	SPI2_NSS pin	Input	PI0 pin: Slave Chip Select pin used in Push-pull pull-up mode.

Table 76. STM32F76xxx/77xxx configuration in system memory boot mode (continued)

Bootloader	Feature/Peripheral	State	Comment
SPI4 bootloader	SPI4	Enabled	The SPI4 configuration is: Slave mode, Full Duplex, 8-bit MSB, Speed up to 8MHz, Polarity: CPOL Low, CPHA Low, NSS hardware.
	SPI4_MOSI pin	Input	PE14 pin: Slave data Input line, used in Push-pull pull-down mode
	SPI4_MISO pin	Output	PE13 pin: Slave data output line, used in Push-pull pull-down mode
	SP4_SCK pin	Input	PE12 pin: Slave clock line, used in Push-pull pull-down mode
	SPI4_NSS pin	Input	PE11 pin: Slave Chip Select pin used in Push-pull pull-up mode.
DFU bootloader	USB	Enabled	USB OTG FS configured in Forced Device mode
	USB_DM pin	Input/Output	PA11 pin: USB DM line.
	USB_DP pin		PA12 pin: USB DP line No external Pull-Up resistor is required.
CAN2 and DFU bootloaders	TIM11	Enabled	This timer is used to determine the value of the HSE. Once HSE frequency is determined, the system clock is configured to 60 MHz using PLL and HSE.

The system clock is derived from the embedded internal high-speed RC for USARTx and I2Cx bootloaders. This internal clock is also used for CAN and DFU (USB FS Device) but only for the selection phase. An external clock multiple of 1 MHz (between 4 and 26 MHz) is required for CAN and DFU bootloader execution after the selection phase.

35.2 Bootloader selection

The [Figure 44](#) and [Figure 45](#) show the bootloader selection mechanism.

Figure 44. Dual Bank Boot Implementation for STM32F76xxx/77xxx Bootloader V9.x

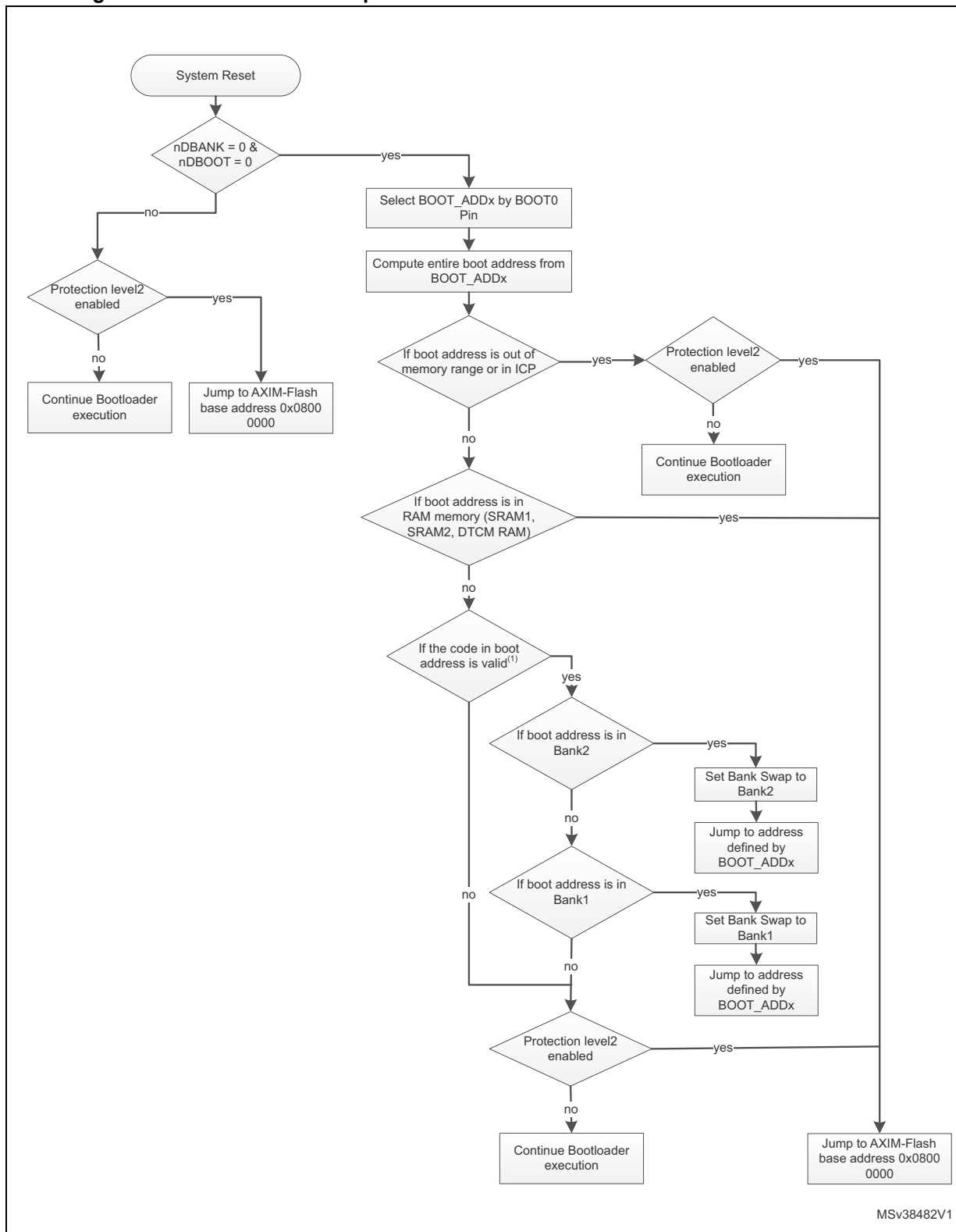

1. ITCM RAM is not considered valid as stack pointer address for the dual bank boot mechanism.

Figure 45. Bootloader V9.x selection for STM32F76xxx/77xxx

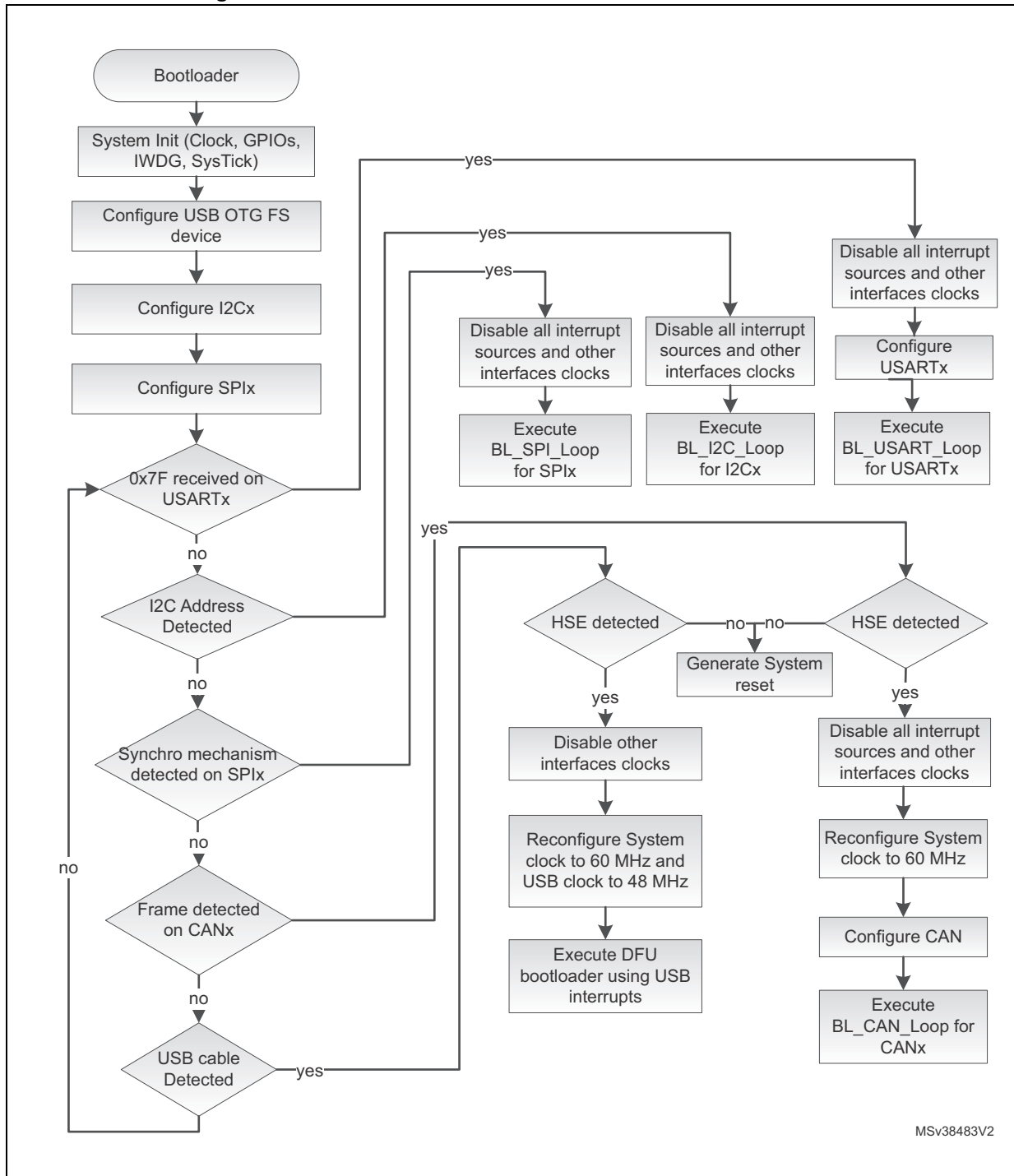

35.3 Bootloader version

The following table lists the STM32F76xxx/77xxx devices bootloader V9.x versions.

Table 77. STM32F76xxx/77xxx bootloader V9.x versions

Bootloader version number	Description	Known limitations
V9.0	Deprecated version (not used)	None
V9.1	Deprecated version (not used)	None
V9.2	Deprecated version (not used)	None
V9.3	Initial bootloader version	None

36 STM32L01xxx/02xxx devices bootloader

36.1 Bootloader configuration

The STM32L01xxx/02xxx bootloader is activated by applying pattern6 (described in [Table 2: Bootloader activation patterns](#)). The following [Table 78](#) shows the hardware resources used by this bootloader.

Table 78. STM32L01xxx/02xxx configuration in system memory boot mode

Bootloader	Feature/Peripheral	State	Comment
Common to all bootloaders	RCC	HSI enabled	The system clock frequency is 32 MHz with HSI 16 MHz as clock source.
	RAM	-	2 Kbytes starting from address 0x20000000 are used by the bootloader firmware
	System memory	-	4 Kbytes starting from address 0x1FF00000, contain the bootloader firmware
	IWDG	-	The independent watchdog (IWDG) prescaler is configured to its maximum value. It is periodically refreshed to prevent watchdog reset (in case the hardware IWDG option was previously enabled by the user).
USART2 bootloader (on PA9/PA10)	USART2	Enabled	Once initialized the USART2 configuration is: 8-bits, even parity and 1 Stop bit
	USART2_RX pin	Input	PA10 pin: USART2 in reception mode
	USART2_TX pin	Output	PA9 pin: USART2 in transmission mode
USART2 bootloader (on PA2/PA3)	USART2	Enabled	Once initialized the USART2 configuration is: 8-bits, even parity and 1 Stop bit
	USART2_RX pin	Input	PA3 pin: USART2 in reception mode
	USART2_TX pin	Output	PA2 pin: USART2 in transmission mode
USART2 bootloader	SysTick timer	Enabled	Used to automatically detect the serial baud rate from the host for USARTx bootloaders.
SPI1 bootloader (for all device packages except TSSOP14)	SPI1	Enabled	The SPI1 configuration is: Slave mode, Full Duplex, 8-bit MSB, Speed up to 8 MHz, Polarity: CPOL Low, CPHA Low, NSS hardware.
	SPI1_MOSI pin	Input	PA7 pin: Slave data Input line, used in Push-pull pull-down mode
	SPI1_MISO pin	Output	PA6 pin: Slave data output line, used in Push-pull pull-down mode
	SPI1_SCK pin	Input	PA5 pin: Slave clock line, used in Push-pull pull-down mode
	SPI1_NSS pin	Input	PA4 pin: Slave Chip Select pin used in Push-pull pull-up mode. Note: This IO can be tied to GND if the SPI Master does not use it.

Table 78. STM32L01xxx/02xxx configuration in system memory boot mode (continued)

Bootloader	Feature/Peripheral	State	Comment
SPI1 bootloader (only for devices on TSSOP14 package)	SPI1	Enabled	The SPI1 configuration is: Slave mode, Full Duplex, 8-bit MSB, Speed up to 8 MHz, Polarity: CPOL Low, CPHA Low, NSS hardware.
	SPI1_MOSI pin	Input	PA7 pin: Slave data Input line, used in Push-pull pull-down mode
	SPI1_MISO pin	Output	PA14 pin: Slave data output line, used in Push-pull pull-down mode
	SPI1_SCK pin	Input	PA13 pin: Slave clock line, used in Push-pull pull-down mode
	SPI1_NSS pin	Input	PA4 pin: Slave Chip Select pin used in Push-pull pull-up mode. Note: NSS pin synchronization is required on Bootloader with SPI1 interface for devices on TSSOP14 package.

The system clock is derived from the embedded internal high-speed RC for all bootloader interfaces. No external quartz is required for bootloader operations.

36.2 Bootloader selection

The [Table 46](#) shows the bootloader selection mechanism.

Figure 46. Bootloader selection for STM32L01xxx/02xxx

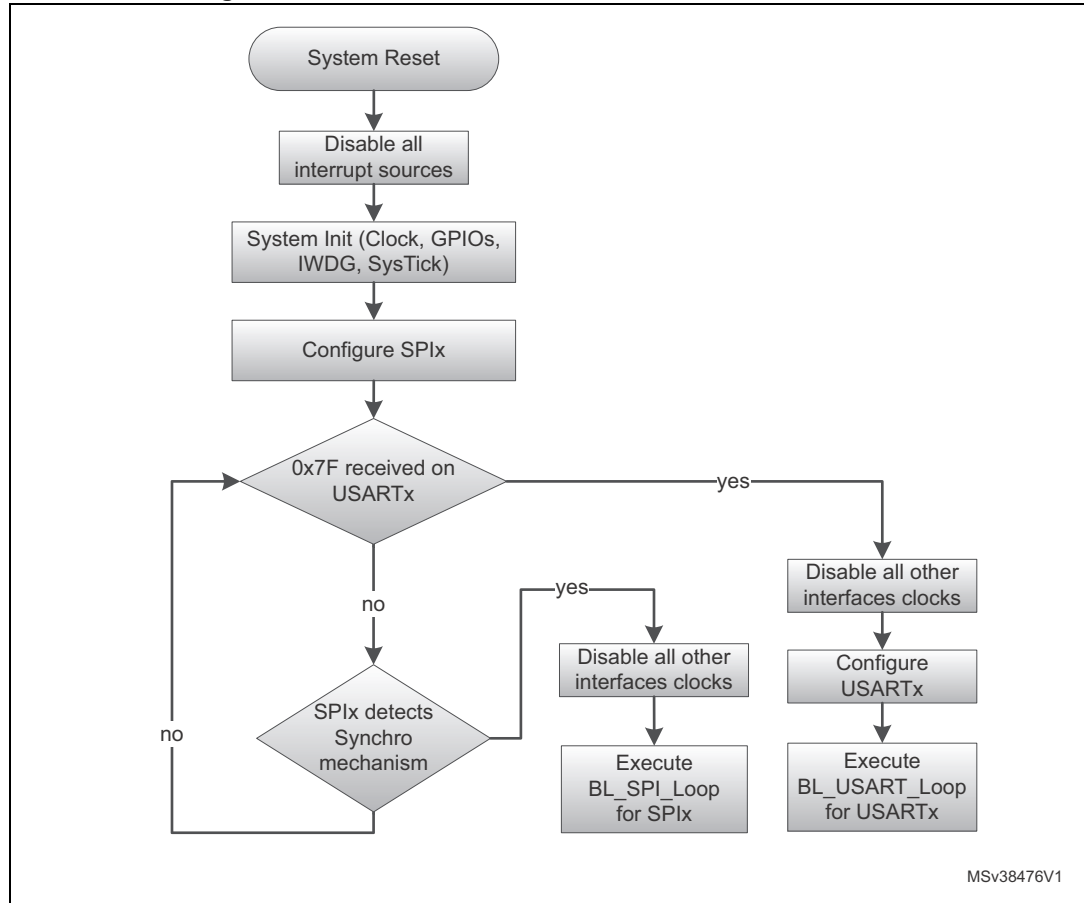

36.3 Bootloader version

The following table lists the STM32L01xxx/02xxx devices bootloader versions.

Table 79. STM32L01xxx/02xxx bootloader versions

Bootloader version number	Description	Known limitations
V12.0	Deprecated version (not used)	None
V12.1	Deprecated version (not used)	None
V12.2	Initial bootloader version	Bootloader not functional with SPI1 interface for devices on TSSOP14 package.
V12.3	This bootloader is an updated version of Bootloader V12.2. This new version add support of SPI interface for devices on TSSOP14 package.	For the SPI1 interface for devices in TSSOP14, a falling edge on NSS pin is required before starting communication, to properly sychronize the SPI interface. If the NSS pin is grounded (all time from device reset) the SPI communication is not synchronized and bootloader does not work properly with the SPI interface.

37 STM32L031xx/041xx devices bootloader

37.1 Bootloader configuration

The STM32L031xx/041xx bootloader is activated by applying pattern2 (described in [Table 2: Bootloader activation patterns](#)). The following table shows the hardware resources used by this bootloader.

Table 80. STM32L031xx/041xx configuration in system memory boot mode

Bootloader	Feature/Peripheral	State	Comment
Common to all bootloaders	RCC	HSI enabled	The system clock frequency is 32 MHz with HSI 16 MHz as clock source.
	RAM	-	4 Kbyte starting from address 0x20000000 are used by the bootloader firmware
	System memory	-	4 Kbyte starting from address 0x1FF00000, contain the bootloader firmware
	IWDG	-	The independent watchdog (IWDG) prescaler is configured to its maximum value. It is periodically refreshed to prevent watchdog reset (in case the hardware IWDG option was previously enabled by the user).
USART2 bootloader (on PA9/PA10)	USART2	Enabled	Once initialized the USART2 configuration is: 8-bits, even parity and 1 Stop bit
	USART2_RX pin	Input	PA10 pin: USART2 in reception mode
	USART2_TX pin	Output	PA9 pin: USART2 in transmission mode
USART2 bootloader (on PA2/PA3)	USART2	Enabled	Once initialized the USART2 configuration is: 8-bits, even parity and 1 Stop bit
	USART2_RX pin	Input	PA3 pin: USART2 in reception mode
	USART2_TX pin	Output	PA2 pin: USART2 in transmission mode
USART2 bootloader	SysTick timer	Enabled	Used to automatically detect the serial baud rate from the host for USARTx bootloaders.

Table 80. STM32L031xx/041xx configuration in system memory boot mode (continued)

Bootloader	Feature/Peripheral	State	Comment
SPI1 bootloader	SPI1	Enabled	The SPI1 configuration is: Slave mode, Full Duplex, 8-bit MSB, Speed up to 8 MHz, Polarity: CPOL Low, CPHA Low, NSS hardware.
	SPI1_MOSI pin	Input	PA7 pin: Slave data Input line, used in Push-pull pull-down mode
	SPI1_MISO pin	Output	PA6 pin: Slave data output line, used in Push-pull pull-down mode
	SPI1_SCK pin	Input	PA5 pin: Slave clock line, used in Push-pull pull-down mode
	SPI1_NSS pin	Input	PA4 pin: Slave Chip Select pin used in Push-pull pull-up mode. Note: This IO can be tied to GND if the SPI Master does not use it.

The system clock is derived from the embedded internal high-speed RC for all bootloader interfaces. No external quartz is required for bootloader operations.

The bootloader Read/Write commands don't support SRAM memory space for this product.

37.2 Bootloader selection

The [Figure 47](#) shows the bootloader selection mechanism.

Figure 47. Bootloader selection for STM32L031xx/041xx

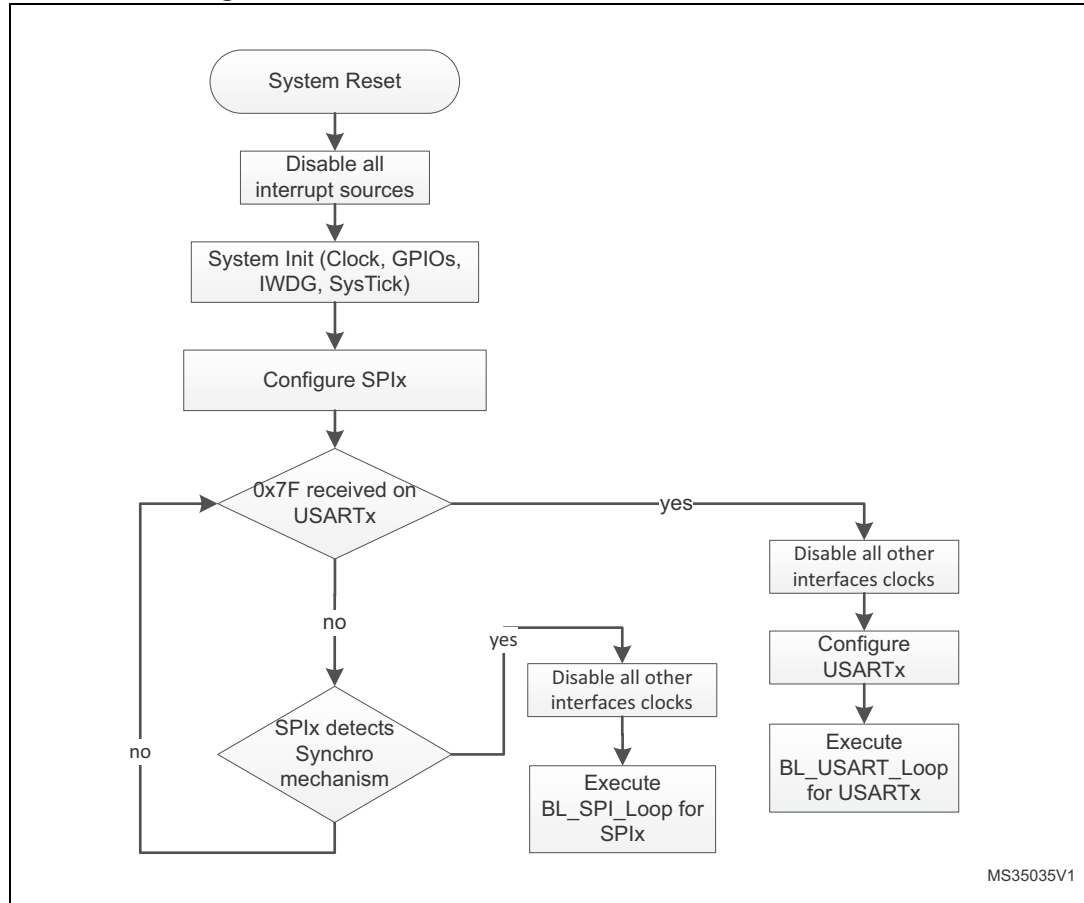

37.3 Bootloader version

The [Table 81](#) lists the STM32L031xx/041xx devices bootloader versions:

Table 81. STM32L031xx/041xx bootloader versions

Bootloader version number	Description	Known limitations
V12.0	Initial bootloader version	None

38 STM32L05xxx/06xxx devices bootloader

38.1 Bootloader configuration

The STM32L05xxx/06xxx bootloader is activated by applying pattern1 (described in [Table 2: Bootloader activation patterns](#)). The following table shows the hardware resources used by this bootloader.

Table 82. STM32L05xxx/06xxx configuration in system memory boot mode

Bootloader	Feature/Peripheral	State	Comment
Common to all bootloaders	RCC	HSI enabled	The system clock frequency is 32 MHz with HSI 16 MHz as clock source.
	Power	-	Voltage range is set to Voltage Range 1.
	RAM	-	4 Kbyte starting from address 0x20000000 are used by the bootloader firmware
	System memory	-	4 Kbyte starting from address 0x1FF00000, contain the bootloader firmware
	IWDG	-	The independent watchdog (IWDG) prescaler is configured to its maximum value. It is periodically refreshed to prevent watchdog reset (in case the hardware IWDG option was previously enabled by the user).
USART1 bootloader	USART1	Enabled	Once initialized the USART1 configuration is: 8-bits, even parity and 1 Stop bit
	USART1_RX pin	Input	PA10 pin: USART1 in reception mode
	USART1_TX pin	Output	PA9 pin: USART1 in transmission mode
USART2 bootloader	USART2	Enabled	Once initialized the USART2 configuration is: 8-bits, even parity and 1 Stop bit
	USART2_RX pin	Input	PA3 pin: USART2 in reception mode
	USART2_TX pin	Output	PA2 pin: USART2 in transmission mode
USARTx bootloaders	SysTick timer	Enabled	Used to automatically detect the serial baud rate from the host for USARTx bootloaders.

Table 82. STM32L05xxx/06xxx configuration in system memory boot mode (continued)

Bootloader	Feature/Peripheral	State	Comment
SPI1 bootloader	SPI1	Enabled	The SPI1 configuration is: Slave mode, Full Duplex, 8-bit MSB, Speed up to 8 MHz, Polarity: CPOL Low, CPHA Low, NSS hardware.
	SPI1_MOSI pin	Input	PA7 pin: Slave data Input line, used in Push-pull pull-down mode
	SPI1_MISO pin	Output	PA6 pin: Slave data output line, used in Push-pull pull-down mode
	SPI1_SCK pin	Input	PA5 pin: Slave clock line, used in Push-pull pull-down mode
	SPI1_NSS pin	Input	PA4 pin: Slave Chip Select pin used in Push-pull pull-down mode.
SPI2 bootloader	SPI2	Enabled	The SPI2 configuration is: Slave mode, Full Duplex, 8-bit MSB, Speed up to 8 MHz, Polarity: CPOL Low, CPHA Low, NSS hardware.
	SPI2_MOSI pin	Input	PB15 pin: Slave data Input line, used in Push-pull pull-down mode
	SPI2_MISO pin	Output	PB14 pin: Slave data output line, used in Push-pull pull-down mode
	SPI2_SCK pin	Input	PB13 pin: Slave clock line, used in Push-pull pull-down mode
	SPI2_NSS pin	Input	PB12 pin: Slave Chip Select pin used in Push-pull pull-down mode.

The system clock is derived from the embedded internal high-speed RC for all bootloader interfaces. No external quartz is required for bootloader operations.

38.2 Bootloader selection

The figure below shows the bootloader selection mechanism.

Figure 48. Bootloader selection for STM32L05xxx/06xxx

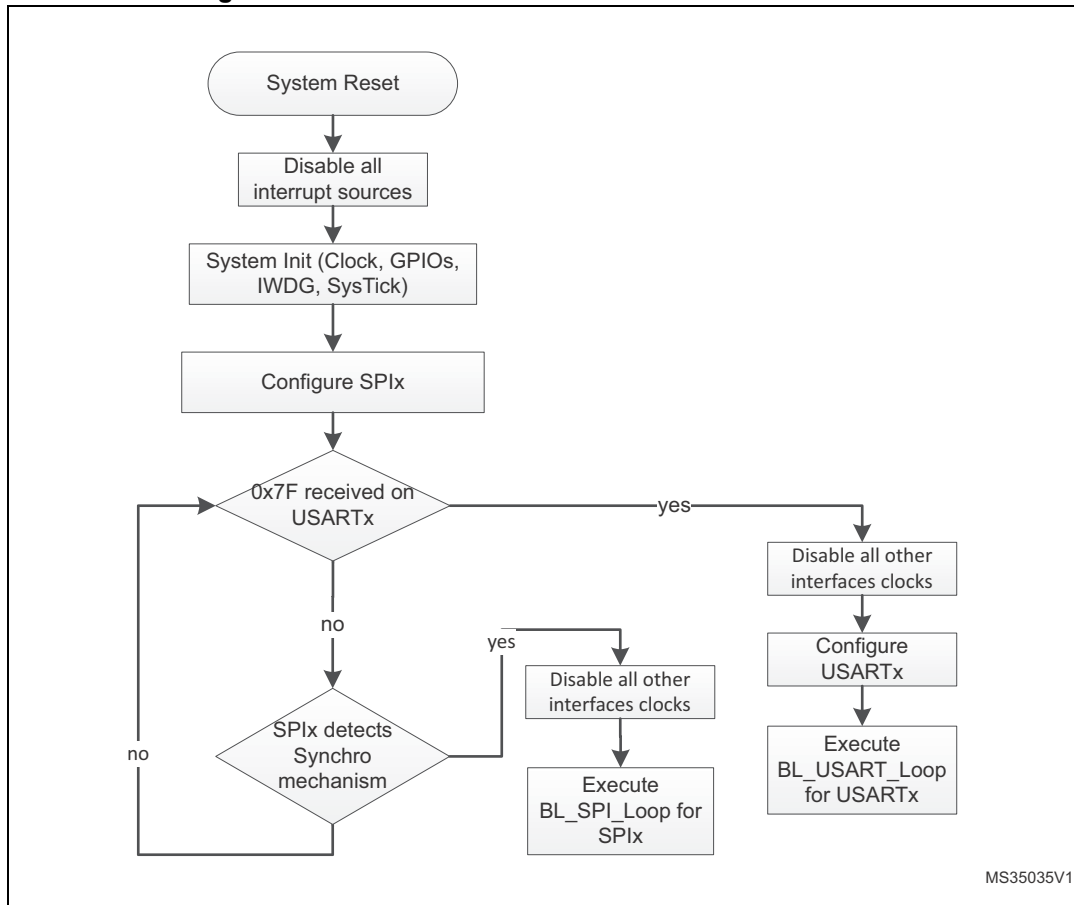

MS35035V1

38.3 Bootloader version

The following table lists the STM32L05xxx/06xxx devices bootloader versions:

Table 83. STM32L05xxx/06xxx bootloader versions

Bootloader version number	Description	Known limitations
V12.0	Initial bootloader version	None

39 STM32L07xxx/08xxx devices bootloader

Two bootloader versions are available on STM32L07xxx/08xxx devices:

- V4.x supporting USART1, USART2 and DFU (USB FS Device).
This version is embedded in STM32L072xx/73xx and STM32L082xx/83xx devices.
- V11.x supporting USART1, USART2, I2C1, I2C2, SPI1 and SPI2.
This version is embedded in other STM32L071xx/081xx devices.

39.1 Bootloader V4.x

39.1.1 Bootloader configuration

The STM32L07xxx/08xxx bootloader is activated by applying pattern2 or pattern7 when dual bank boot feature is available (described in [Table 2: Bootloader activation patterns](#)). The [Table 84](#) shows the hardware resources used by this bootloader.

Table 84. STM32L07xxx/08xxx configuration in system memory boot mode

Bootloader	Feature/Peripheral	State	Comment
Common to all bootloaders	RCC	HSI enabled	The system clock frequency is 32 MHz with HSI 16 MHz as clock source.
	RAM	-	4 Kbyte starting from address 0x20000000 are used by the bootloader firmware.
	System memory	-	8 Kbyte starting from address 0x1FF00000, contain the bootloader firmware.
	IWDG	-	The independent watchdog (IWDG) prescaler is configured to its maximum value. It is periodically refreshed to prevent watchdog reset (in case the hardware IWDG option was previously enabled by the user).
USART1 bootloader	USART1	Enabled	Once initialized the USART1 configuration is: 8-bits, even parity and 1 Stop bit
	USART1_RX pin	Input	PA10 pin: USART2 in reception mode
	USART1_TX pin	Output	PA9 pin: USART2 in transmission mode
USART2 bootloader	USART2	Enabled	Once initialized the USART2 configuration is: 8-bits, even parity and 1 Stop bit
	USART2_RX pin	Input	PA3 pin: USART2 in reception mode
	USART2_TX pin	Output	PA2 pin: USART2 in transmission mode
USARTx bootloaders	SysTick timer	Enabled	Used to automatically detect the serial baud rate from the host for USARTx bootloaders.

Table 84. STM32L07xxx/08xxx configuration in system memory boot mode (continued)

Bootloader	Feature/Peripheral	State	Comment
DFU bootloader	USB	Enabled	USB FS configured in Forced Device mode. USB FS interrupt vector is enabled and used for USB DFU communications.
	USB_DM pin	Input/Output	PA11 pin: USB FS DM line
	USB_DP pin		PA12 pin: USB FS DP line. No external Pull-up resistor is required.

The system clock is derived from the embedded internal high-speed RC for all bootloader interfaces. No external quartz is required for bootloader operations.

39.1.2 Bootloader selection

The [Figure 49](#) and [Figure 50](#) show the bootloader selection mechanism.

Figure 49. Dual Bank Boot Implementation for STM32L07xxx/08xxx Bootloader V4.x

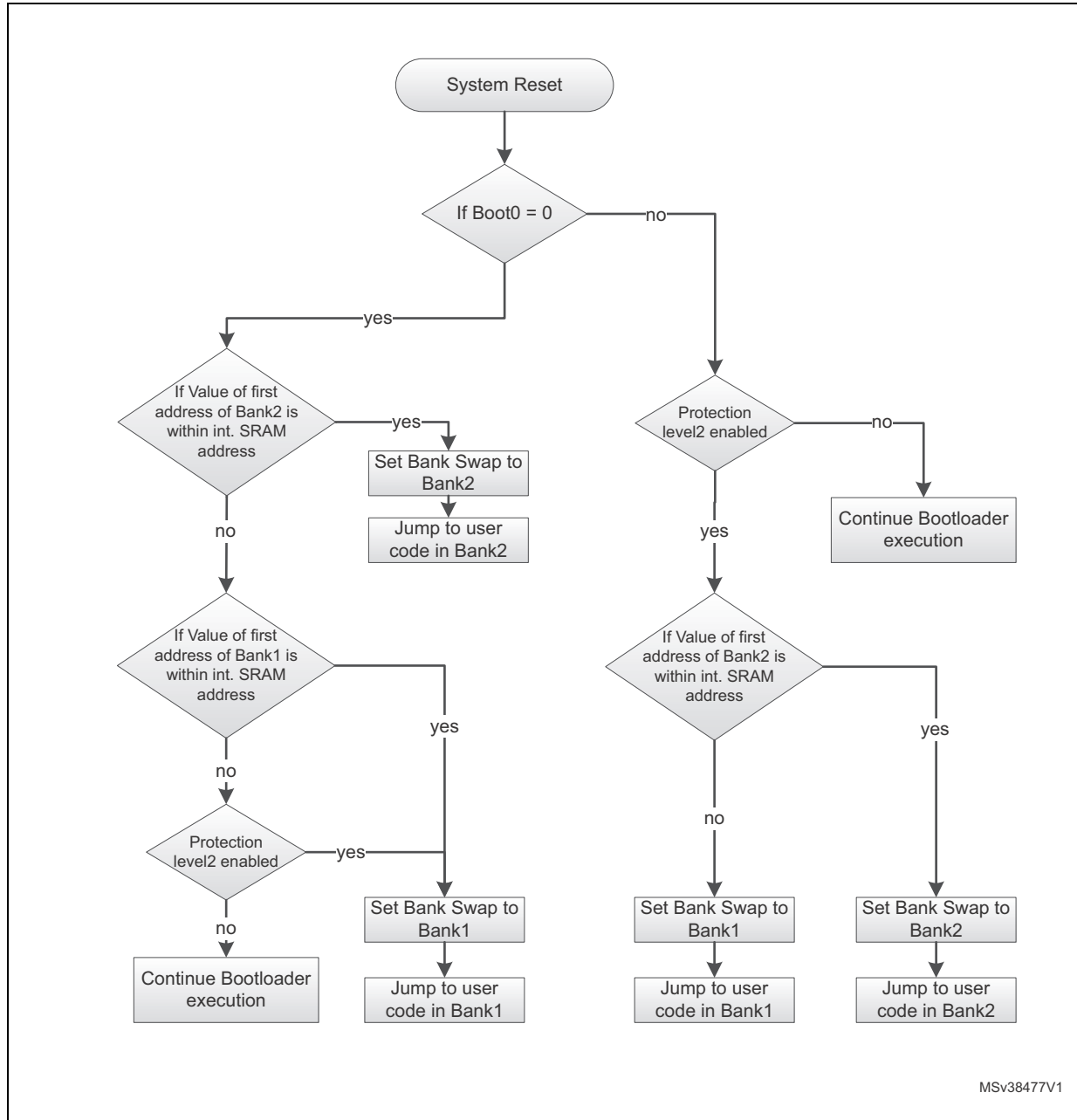
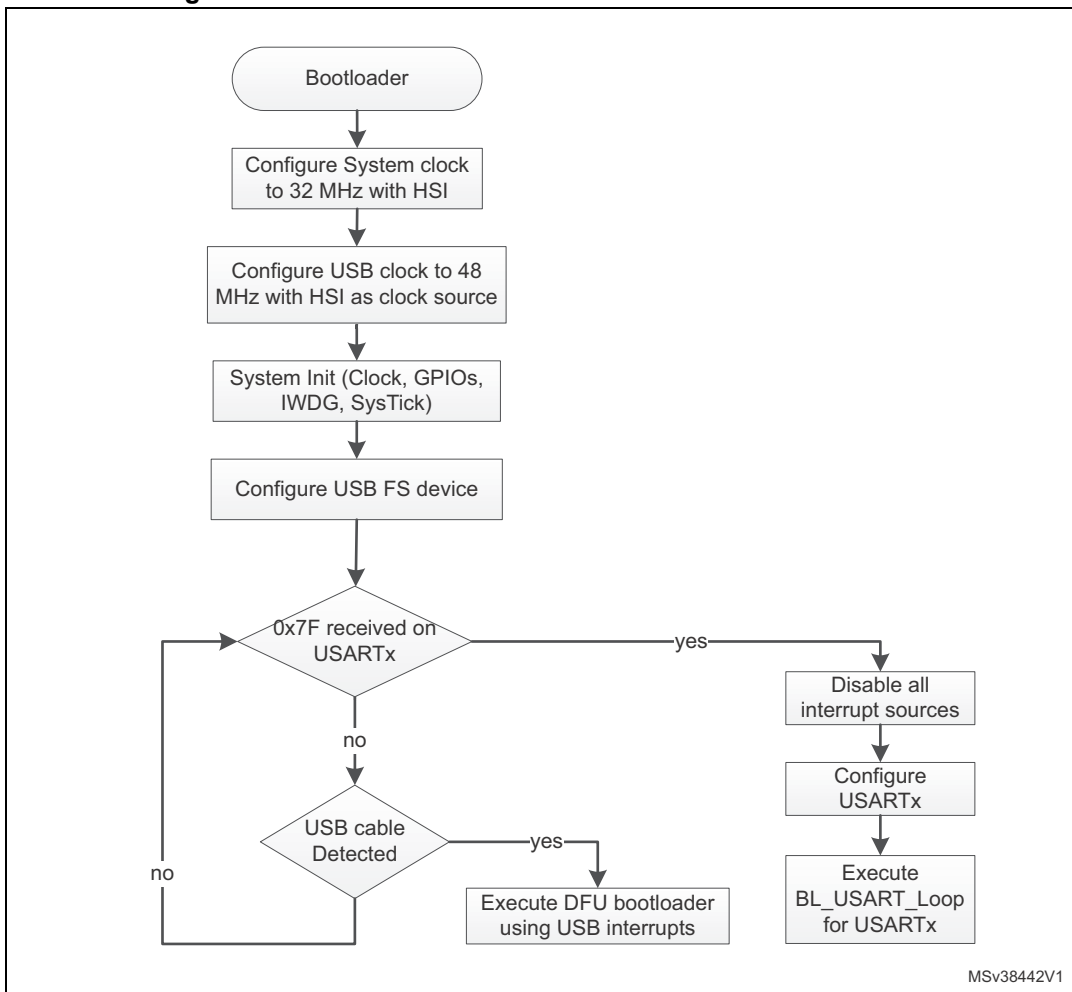

Figure 50. Bootloader V4.x selection for STM32L07xxx/08xxx



39.1.3 Bootloader version

The [Table 85](#) lists the STM32L07xxx/08xxx devices bootloader versions:

Table 85. STM32L07xxx/08xxx bootloader versions

Bootloader version number	Description	Known limitations
V4.0	Initial bootloader version	None
V4.1	This bootloader is an updated version of Bootloader V4.0. This new version implements the Dual Bank Boot feature.	None

39.2 Bootloader V11.x

39.2.1 Bootloader configuration

The STM32L07xxx/08xxx bootloader is activated by applying pattern2 or pattern7 when dual bank boot feature is available (described in [Table 2: Bootloader activation patterns](#)). The [Table 86](#) shows the hardware resources used by this bootloader.

Table 86. STM32L07xxx/08xxx configuration in system memory boot mode

Bootloader	Feature/Peripheral	State	Comment
Common to all bootloaders	RCC	HSI enabled	The system clock frequency is 32 MHz with HSI 16 MHz as clock source.
	RAM	-	5 Kbyte starting from address 0x20000000 are used by the bootloader firmware
	System memory	-	8 Kbyte starting from address 0x1FF00000, contain the bootloader firmware
	IWDG	-	The independent watchdog (IWDG) prescaler is configured to its maximum value. It is periodically refreshed to prevent watchdog reset (in case the hardware IWDG option was previously enabled by the user).
USART1 bootloader	USART1	Enabled	Once initialized the USART1 configuration is: 8-bits, even parity and 1 Stop bit
	USART1_RX pin	Input	PA10 pin: USART2 in reception mode
	USART1_TX pin	Output	PA9 pin: USART2 in transmission mode
USART2 bootloader	USART2	Enabled	Once initialized the USART2 configuration is: 8-bits, even parity and 1 Stop bit
	USART2_RX pin	Input	PA3 pin: USART2 in reception mode
	USART2_TX pin	Output	PA2 pin: USART2 in transmission mode
USARTx bootloaders	SysTick timer	Enabled	Used to automatically detect the serial baud rate from the host for USARTx bootloaders.
I2C1 bootloader	I2C1	Enabled	The I2C1 configuration is: I2C speed: up to 400 KHz, 7-bit address, slave mode, analog filter ON. Slave 7-bit address: 0b1000010x (where x = 0 for write and x = 1 for read)
	I2C1_SCL pin	Input/Output	PB6 pin: I2C1 clock line is used in open-drain mode.
	I2C1_SDA pin	Input/Output	PB7 pin: I2C1 data line is used in open-drain mode.

Table 86. STM32L07xxx/08xxx configuration in system memory boot mode (continued)

Bootloader	Feature/Peripheral	State	Comment
I2C2 bootloader	I2C2	Enabled	The I2C2 configuration is: I2C speed: up to 400 KHz, 7-bit address, slave mode, analog filter ON. Slave 7-bit address: 0b1000010x (where x = 0 for write and x = 1 for read)
	I2C2_SCL pin	Input/Output	PB10 pin: I2C2 clock line is used in open-drain mode.
	I2C2_SDA pin	Input/Output	PB11 pin: I2C2 data line is used in open-drain mode.
SPI1 bootloader	SPI1	Enabled	The SPI1 configuration is: Slave mode, Full Duplex, 8-bit MSB, Speed up to 8 MHz, Polarity: CPOL Low, CPHA Low, NSS hardware.
	SPI1_MOSI pin	Input	PA7 pin: Slave data Input line, used in Push-pull pull-down mode
	SPI1_MISO pin	Output	PA6 pin: Slave data output line, used in Push-pull pull-down mode
	SPI1_SCK pin	Input	PA5 pin: Slave clock line, used in Push-pull pull-down mode
	SPI1_NSS pin	Input	PA4 pin: Slave Chip Select pin used in Push-pull pull-up mode. Note: This IO can be tied to Gnd if the SPI Master does not use it.
SPI2 bootloader	SPI2	Enabled	The SPI2 configuration is: Slave mode, Full Duplex, 8-bit MSB, Speed up to 8 MHz, Polarity: CPOL Low, CPHA Low, NSS hardware.
	SPI2_MOSI pin	Input	PB15 pin: Slave data Input line, used in Push-pull pull-down mode
	SPI2_MISO pin	Output	PB14 pin: Slave data output line, used in Push-pull pull-down mode
	SPI2_SCK pin	Input	PB13 pin: Slave clock line, used in Push-pull pull-down mode
	SPI2_NSS pin	Input	PB12 pin: Slave Chip Select pin used in Push-pull pull-up mode. Note: This IO can be tied to GND if the SPI Master does not use it.

The system clock is derived from the embedded internal high-speed RC for all bootloader interfaces. No external quartz is required for bootloader operations.

39.2.2 Bootloader selection

The [Figure 51](#) and [Figure 52](#) show the bootloader selection mechanism.

Figure 51. Dual Bank Boot Implementation for STM32L07xxx/08xxx Bootloader V11.x

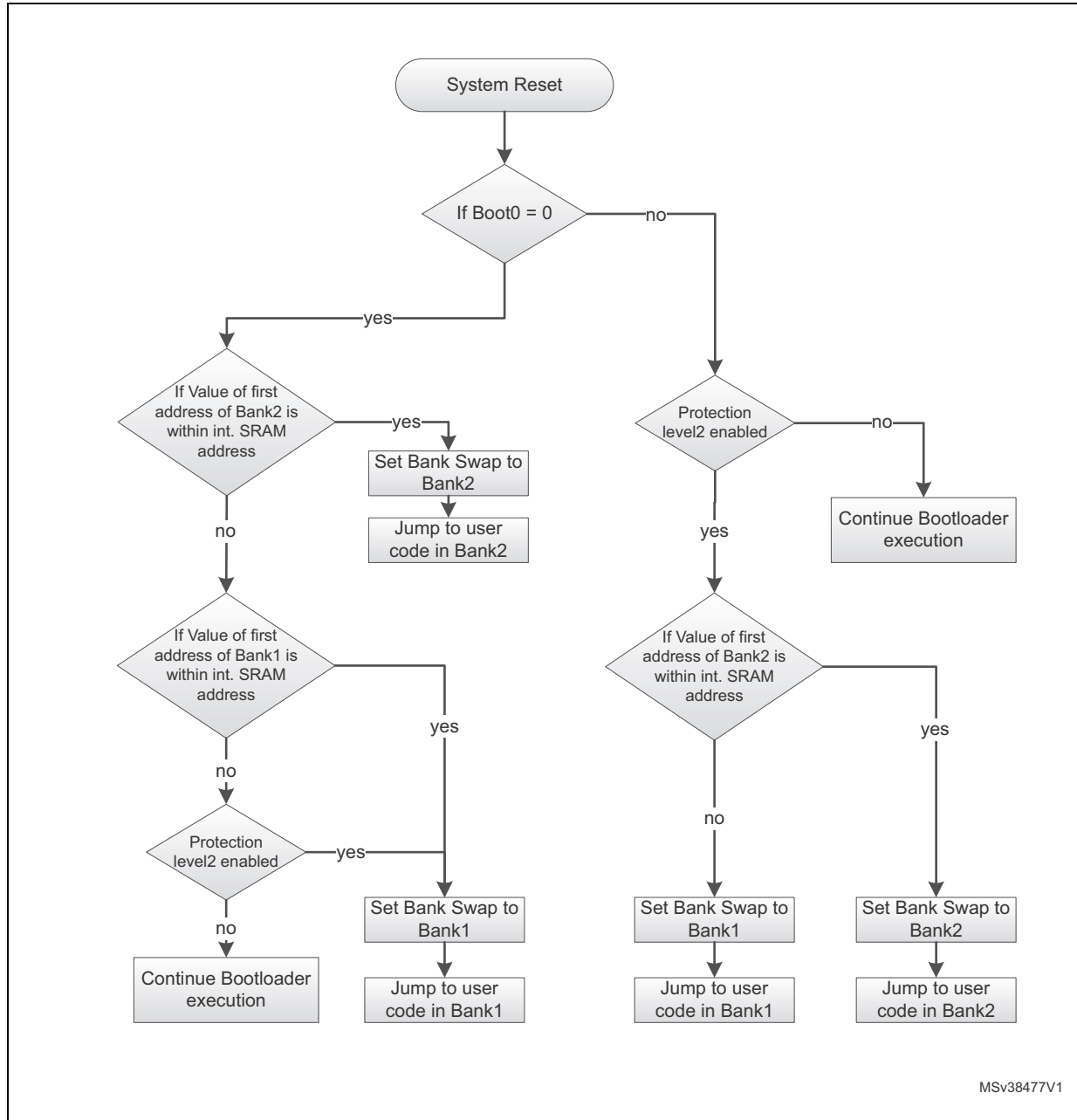

MSv38477V1

Figure 52. Bootloader V11.x selection for STM32L07xxx/08xxx

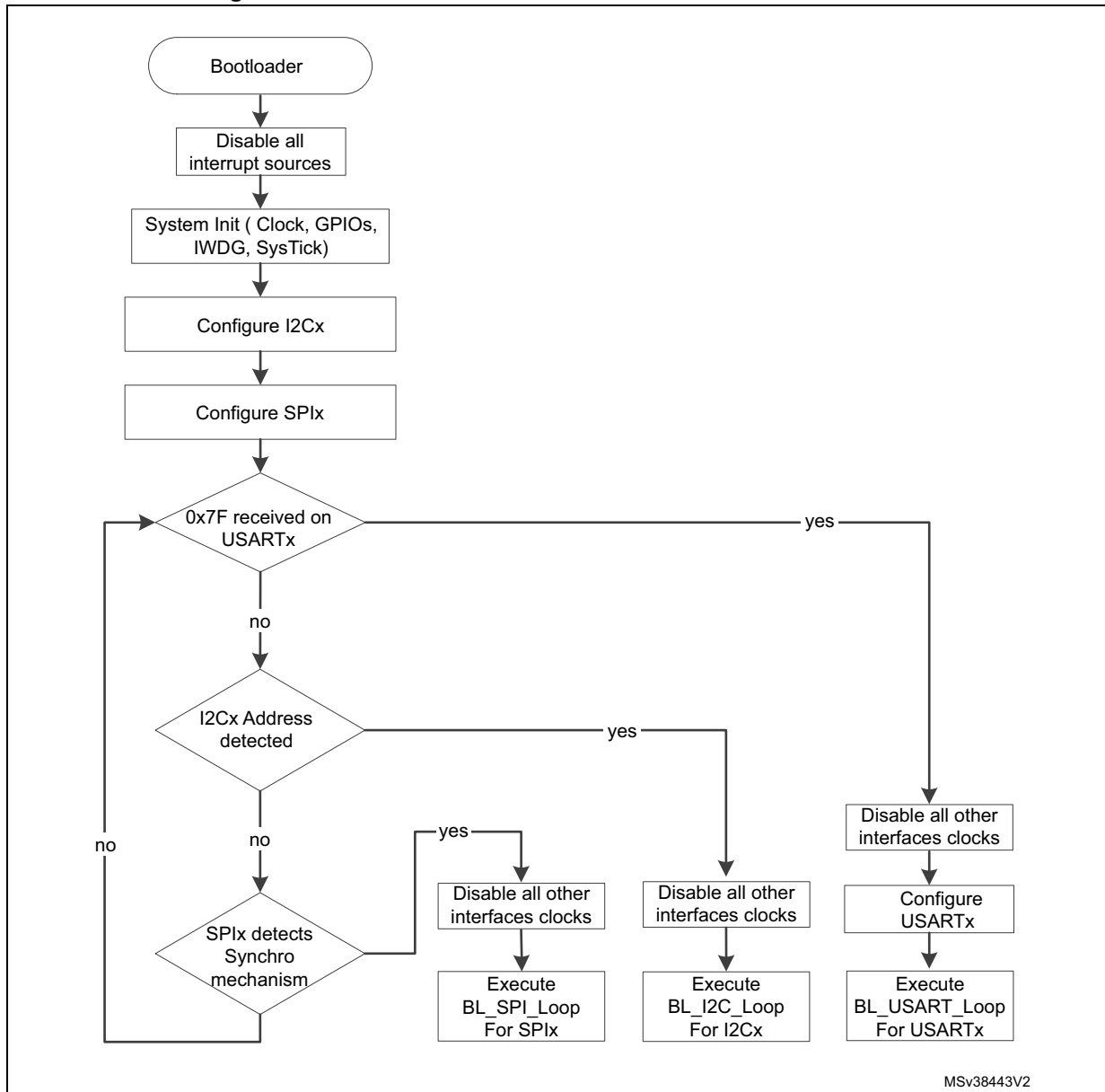

39.2.3 Bootloader version

The following table lists the STM32L07xxx/08xxx devices bootloader versions:

Table 87. STM32L07xxx/08xxx bootloader V11.x versions

Bootloader version number	Description	Known limitations
V11.0	Deprecated version (not used)	None
V11.1	Initial bootloader version	None
V11.2	This bootloader is an updated version of Bootloader V11.1. This new version implements the Dual Bank Boot feature.	None

40 STM32L1xxx6(8/B)A devices bootloader

40.1 Bootloader configuration

The STM32L1xxx6(8/B)A bootloader is activated by applying pattern1 (described in [Table 2: Bootloader activation patterns](#)). The following table shows the hardware resources used by this bootloader.

Table 88. STM32L1xxx6(8/B)A configuration in system memory boot mode

Bootloader	Feature/Peripheral	State	Comment
Common to all bootloaders	RCC	HSI enabled	The system clock frequency is 16 MHz.
	RAM	-	2 Kbyte starting from address 0x20000000 are used by the bootloader firmware.
	System memory	-	4 Kbyte starting from address 0x1FF00000 contain the bootloader firmware.
	IWDG	-	The independent watchdog (IWDG) prescaler is configured to its maximum value and is periodically refreshed to prevent watchdog reset (in case the hardware IWDG option was previously enabled by the user).
	Power	-	Voltage range is set to Voltage Range 1.
USART1 bootloader	USART1	Enabled	Once initialized, the USART1 configuration is: 8 bits, even parity and 1 Stop bit.
	USART1_RX pin	Input	PA10 pin: USART1 in reception mode
	USART1_TX pin	Output	PA9 pin: USART1 in transmission mode
USART2 bootloader	USART2	Enabled	Once initialized, the USART2 configuration is: 8 bits, even parity and 1 Stop bit.
	USART2_RX pin	Input	PD6 pin: USART2 in reception mode
	USART2_TX pin	Output	PD5 pin: USART2 in transmission mode
USARTx bootloaders	SysTick timer	Enabled	Used to automatically detect the serial baud rate from the host.

The system clock is derived from the embedded internal high-speed RC, no external quartz is required for the bootloader execution.

40.2 Bootloader selection

The figure below shows the bootloader selection mechanism.

Figure 53. Bootloader selection for STM32L1xxx6(8/B)A devices

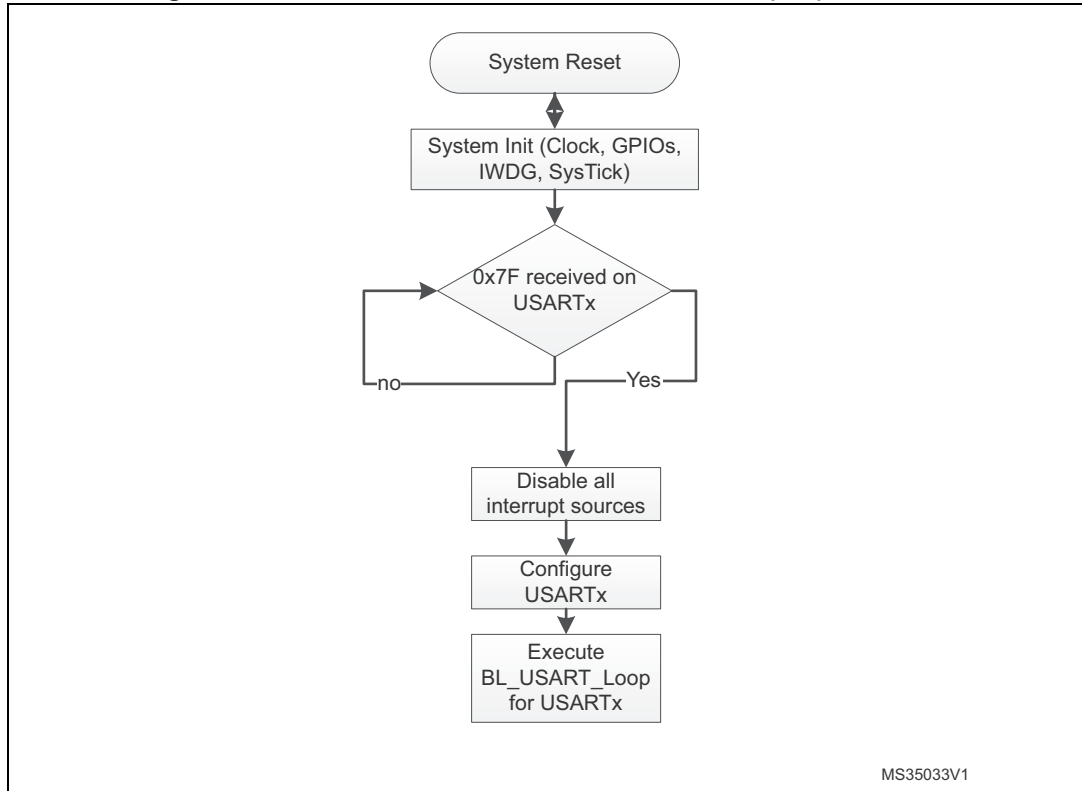

40.3 Bootloader version

The following table lists the STM32L1xxx6(8/B)A devices bootloader versions:

Table 89. STM32L1xxx6(8/B)A bootloader versions

Bootloader version number	Description	Known limitations
V2.0	Initial bootloader version	When a Read Memory command or Write Memory command is issued with an unsupported memory address and a correct address checksum (ie. address 0x6000 0000), the command is aborted by the bootloader device, but the NACK (0x1F) is not sent to the host. As a result, the next 2 bytes (which are the number of bytes to be read/written and its checksum) are considered as a new command and its checksum. ⁽¹⁾

1. If the “number of data - 1” (N-1) to be read/written is not equal to a valid command code, then the limitation is not perceived from the host since the command is NACKed anyway (as an unsupported new command).

41 STM32L1xxx6(8/B) devices bootloader

41.1 Bootloader configuration

The STM32L1xxx6(8/B) bootloader is activated by applying pattern1 (described in [Table 2: Bootloader activation patterns](#)). The following table shows the hardware resources used by this bootloader.

Table 90. STM32L1xxx6(8/B) configuration in system memory boot mode

Bootloader	Feature/Peripheral	State	Comment
Common to all bootloaders	RCC	HSI enabled	The system clock frequency is 16 MHz.
	RAM	-	2 Kbyte starting from address 0x20000000 are used by the bootloader firmware.
	System memory	-	4 Kbyte starting from address 0x1FF00000 contain the bootloader firmware.
	IWDG	-	The independent watchdog (IWDG) prescaler is configured to its maximum value and is periodically refreshed to prevent watchdog reset (in case the hardware IWDG option was previously enabled by the user).
	Power	-	Voltage range is set to Voltage Range 1.
USART1 bootloader	USART1	Enabled	Once initialized, the USART1 configuration is: 8 bits, even parity and 1 Stop bit.
	USART1_RX pin	Input	PA10 pin: USART1 in reception mode
	USART1_TX pin	Output	PA9 pin: USART1 in transmission mode
USART2 bootloader	USART2	Enabled	Once initialized, the USART2 configuration is: 8 bits, even parity and 1 Stop bit.
	USART2_RX pin	Input	PD6 pin: USART2 in reception mode
	USART2_TX pin	Output	PD5 pin: USART2 in transmission mode
USARTx bootloaders	SysTick timer	Enabled	Used to automatically detect the serial baud rate from the host.

The system clock is derived from the embedded internal high-speed RC, no external quartz is required for the bootloader execution.

41.2 Bootloader selection

The figure below shows the bootloader selection mechanism.

Figure 54. Bootloader selection for STM32L1xxx6(8/B) devices

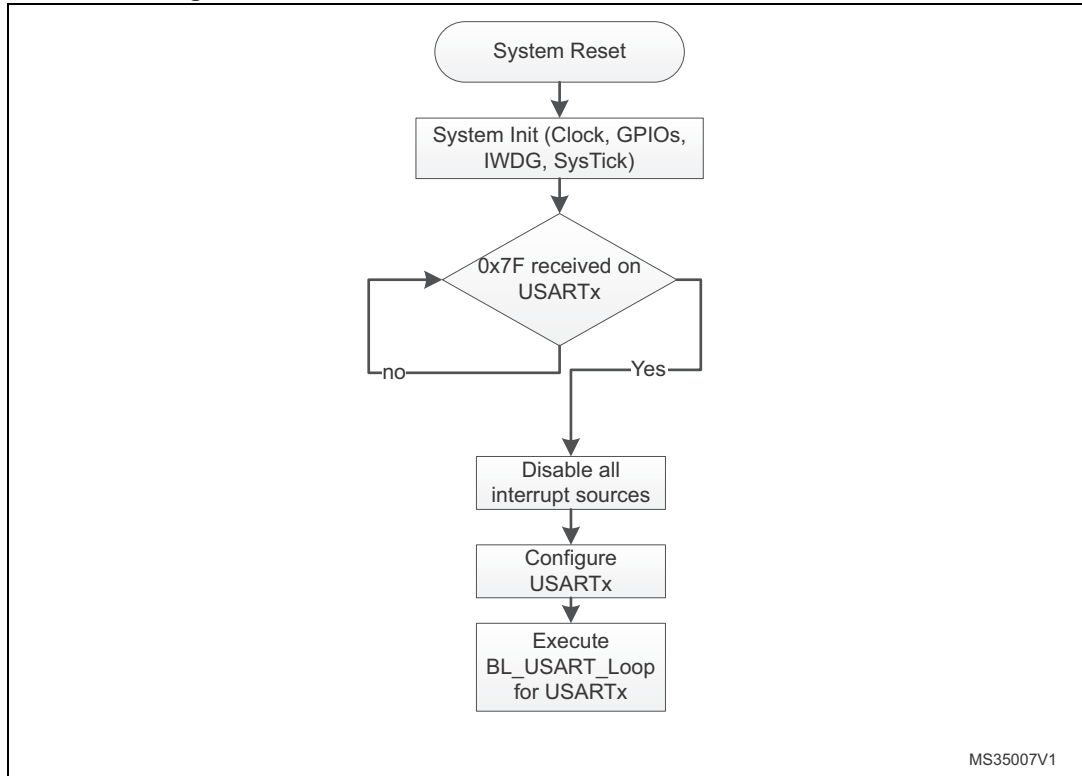

41.3 Bootloader version

The following table lists the STM32L1xxx6(8/B) devices bootloader versions:

Table 91. STM32L1xxx6(8/B) bootloader versions

Bootloader version number	Description	Known limitations
V2.0	Initial bootloader version	When a Read Memory command or Write Memory command is issued with an unsupported memory address and a correct address checksum (ie. address 0x6000 0000), the command is aborted by the bootloader device, but the NACK (0x1F) is not sent to the host. As a result, the next 2 bytes (which are the number of bytes to be read/written and its checksum) are considered as a new command and its checksum. ⁽¹⁾

1. If the “number of data - 1” (N-1) to be read/written is not equal to a valid command code, then the limitation is not perceived from the host since the command is NACKed anyway (as an unsupported new command).

42 STM32L1xxxC devices bootloader

42.1 Bootloader configuration

The STM32L1xxxC bootloader is activated by applying pattern1 (described in [Table 2: Bootloader activation patterns](#)). The following table shows the hardware resources used by this bootloader.

Table 92. STM32L1xxxC configuration in system memory boot mode

Bootloader	Feature/Peripheral	State	Comment
Common to all bootloaders	RCC	HSI enabled	The system clock frequency is 16 MHz using the HSI. This is used only for USARTx bootloaders and during USB detection for DFU bootloader (once the DFU bootloader is selected, the clock source is derived from the external crystal).
		HSE enabled	The external clock is mandatory only for the DFU bootloader and must be in the following range: [24, 16, 12, 8, 6, 4, 3, 2] MHz. The PLL is used to generate the USB 48 MHz clock and the 32 MHz clock for the system clock.
		-	The Clock Security System (CSS) interrupt is enabled for the DFU bootloader. Any failure (or removal) of the external clock generates a system reset.
	IWDG	-	The independent watchdog (IWDG) prescaler is configured to its maximum value and is periodically refreshed to prevent watchdog resets (in case the hardware IWDG option was previously enabled by the user).
	Power	-	Voltage range is set to Voltage Range 1.
	System memory	-	8 Kbyte starting from address 0x1FF0 0000. This area contains the bootloader firmware.
	RAM	-	4 Kbyte starting from address 0x20000000 are used by the bootloader firmware.
USART1 bootloader	USART1	Enabled	Once initialized, the USART1 configuration is 8 bits, even parity and 1 stop bit.
	USART1_RX pin	Input	PA10 pin: USART1 in reception mode
	USART1_TX pin	Output	PA9 pin: USART1 in transmission mode
USARTx bootloaders	SysTick timer	Enabled	Used to automatically detect the serial baud rate from the host for the USARTx bootloader.

Table 92. STM32L1xxxC configuration in system memory boot mode (continued)

Bootloader	Feature/Peripheral	State	Comment
USART2 bootloader	USART2	Enabled	Once initialized, the USART2 configuration is 8 bits, even parity and 1 stop bit. The USART2 uses its remapped pins.
	USART2_RX pin	Input	PD6 pin: USART2 in reception mode
	USART2_TX pin	Output	PD5 pin: USART2 in transmission mode
DFU bootloader	USB	Enabled	USB used in FS mode
	USB_DM pin	Input/Output	PA11: USB DM line.
	USB_DP pin		PA12: USB DP line An external pull-up resistor 1.5 KOhm must be connected to USB_DP pin.

The system clock is derived from the embedded internal high-speed RC for the USARTx bootloader. This internal clock is also used for DFU bootloader but only for the selection phase. An external clock in the range of [24, 16, 12, 8, 6, 4, 3, 2] MHz is required for the execution of the DFU bootloader after the selection phase.

42.2 Bootloader selection

The figure below shows the bootloader selection mechanism.

Figure 55. Bootloader selection for STM32L1xxxC devices

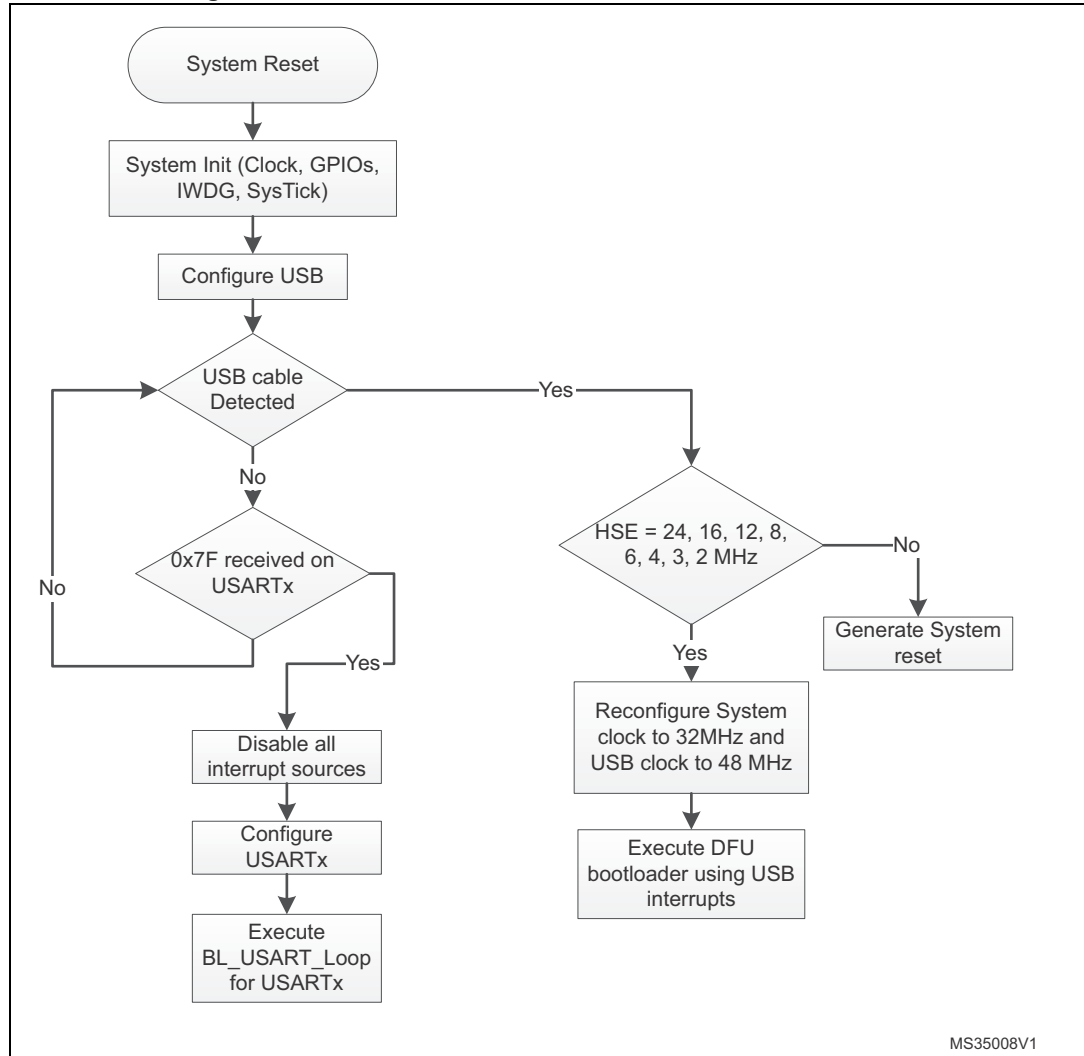

MS35008V1

42.3 Bootloader version

The following table lists the STM32L1xxxC devices bootloader versions:

Table 93. STM32L1xxxC bootloader versions

Bootloader version number	Description	Known limitations
V4.0	Initial bootloader version	For the USART interface, two consecutive NACKs instead of 1 NACK are sent when a Read Memory or Write Memory command is sent and the RDP level is active.

43 STM32L1xxxD devices bootloader

43.1 Bootloader configuration

The STM32L1xxxD bootloader is activated by applying pattern4 (described in [Table 2: Bootloader activation patterns](#)). The following table shows the hardware resources used by this bootloader.

Table 94. STM32L1xxxD configuration in system memory boot mode

Bootloader	Feature/Peripheral	State	Comment
Common to all bootloaders	RCC	HSI enabled	The system clock frequency is 16 MHz using the HSI. This is used only for USARTx bootloaders and during USB detection for DFU bootloader (once the DFU bootloader is selected, the clock source will be derived from the external crystal).
		HSE enabled	The external clock is mandatory only for DFU bootloader and it must be in the following range: [24, 16, 12, 8, 6, 4, 3, 2] MHz. The PLL is used to generate the USB 48 MHz clock and the 32 MHz clock for the system clock.
		-	The Clock Security System (CSS) interrupt is enabled for the DFU bootloader. Any failure (or removal) of the external clock generates system reset.
	IWDG	-	The independent watchdog (IWDG) prescaler is configured to its maximum value and is periodically refreshed to prevent watchdog reset (in case the hardware IWDG option was previously enabled by the user).
	Power	-	Voltage range is set to Voltage Range 1.
	System memory	-	8 Kbyte starting from address 0x1FF0 0000. This area contains the bootloader firmware.
	RAM	-	4 Kbyte starting from address 0x20000000 are used by the bootloader firmware.
USART1 bootloader	USART1	Enabled	Once initialized, the USART1 configuration is: 8 bits, even parity and 1 Stop bit.
	USART1_RX pin	Input	PA10 pin: USART1 in reception mode
	USART1_TX pin	Output	PA9 pin: USART1 in transmission mode
USARTx bootloaders	SysTick timer	Enabled	Used to automatically detect the serial baud rate from the host for USARTx bootloader.

Table 94. STM32L1xxxD configuration in system memory boot mode (continued)

Bootloader	Feature/Peripheral	State	Comment
USART2 bootloader	USART2	Enabled	Once initialized, the USART2 configuration is: 8 bits, even parity and 1 Stop bit. The USART2 uses its remapped pins.
	USART2_RX pin	Input	PD6 pin: USART2 in reception mode
	USART2_TX pin	Output	PD5 pin: USART2 in transmission mode
DFU bootloader	USB	Enabled	USB used in FS mode
	USB_DM pin	Input/Output	PA11: USB DM line.
	USB_DP pin		PA12: USB DP line An external pull-up resistor 1.5 KOhm must be connected to USB_DP pin.

The system clock is derived from the embedded internal high-speed RC for USARTx bootloader. This internal clock is used also for DFU bootloader but only for the selection phase. An external clock in the range of [24, 16, 12, 8, 6, 4, 3, 2] MHz is required for DFU bootloader execution after the selection phase.

43.2 Bootloader selection

The figure below shows the bootloader selection mechanism.

Figure 56. Bootloader selection for STM32L1xxxD devices

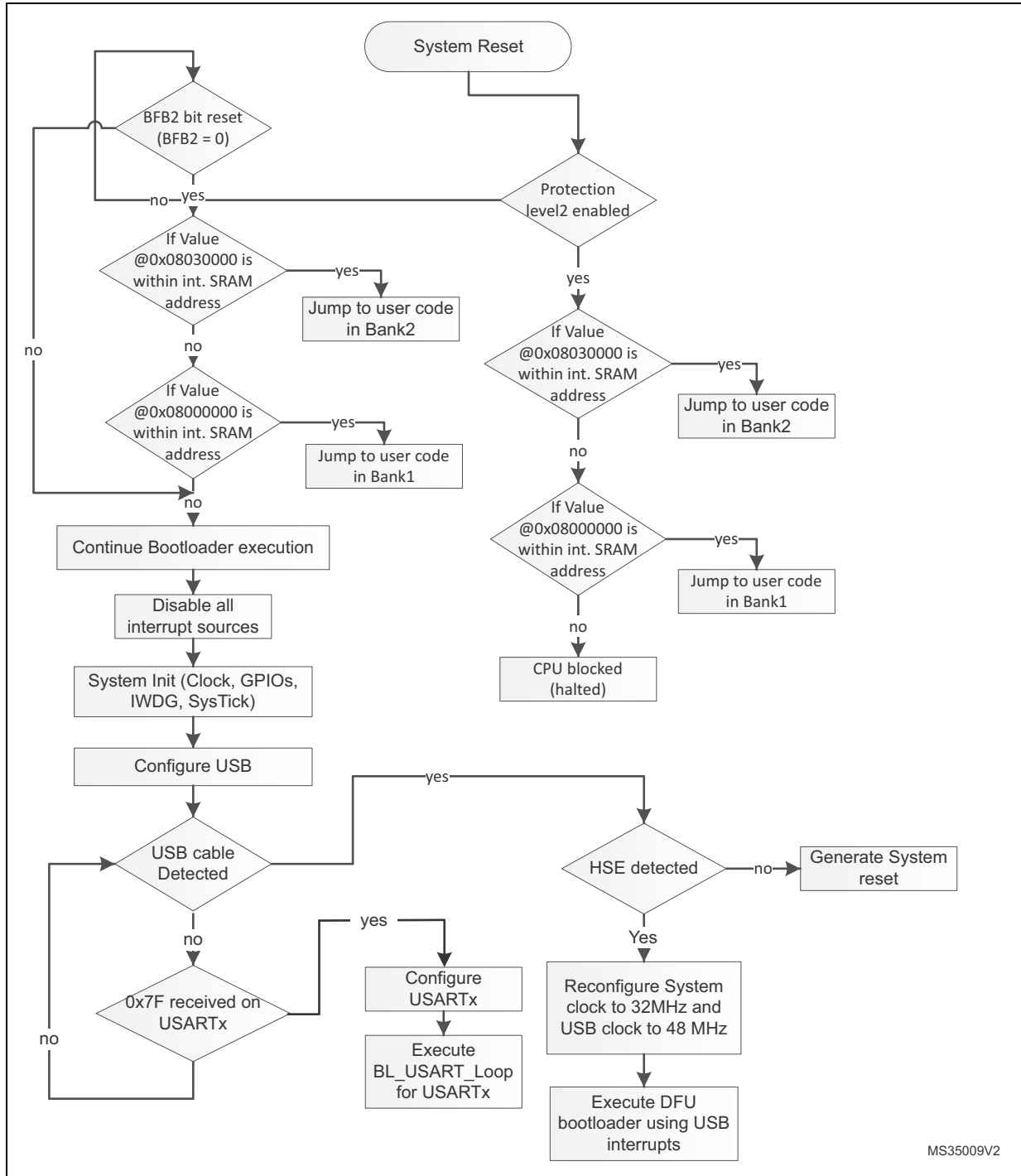

MS35009V2

43.3 Bootloader version

The following table lists the STM32L1xxxD devices bootloader versions:

Table 95. STM32L1xxxD bootloader versions

Bootloader version number	Description	Known limitations
V4.1	Initial bootloader version	<ul style="list-style-type: none"> – In the bootloader code the PA13 (JTMS/SWDIO) I/O output speed is configured to 400 KHz, as consequence some debugger can not connect to the device in Serial Wire mode when the bootloader is running. – When the DFU bootloader is selected, the RTC is reset and thus all RTC information (calendar, alarm, ...) will be lost including backup registers. Note: When the USART bootloader is selected there is no change on the RTC configuration (including backup registers).
V4.2	Fix V4.1 limitations (available on Rev.Z devices only.)	<ul style="list-style-type: none"> – Stack overflow by 8 bytes when jumping to Bank1/Bank2 if BFB2=0 or when Read Protection level is set to 2. Workaround: the user code should force in the startup file the top of stack address before to jump to the main program. This can be done in the "Reset_Handler" routine. – When the Stack of the user code is placed outside the SRAM (ie. @ 0x2000C000) the bootloader cannot jump to that user code which is considered invalid. This might happen when using compilers which place the stack at a non-physical address at the top of the SRAM (ie. @ 0x2000C000). Workaround: place manually the stack at a physical address.
V4.5	Fix V4.2 limitations. DFU interface robustness enhancements (available on Rev.Y devices only).	<ul style="list-style-type: none"> – For the USART interface, two consecutive NACKs (instead of 1 NACK) are sent when a Read Memory or Write Memory command is sent and the RDP level is active.

44 STM32L1xxxE devices bootloader

44.1 Bootloader configuration

The STM32L1xxxE bootloader is activated by applying pattern4 (described in [Table 2: Bootloader activation patterns](#)). The following table shows the hardware resources used by this bootloader.

Table 96. STM32L1xxxE configuration in system memory boot mode

Bootloader	Feature/Peripheral	State	Comment
Common to all bootloaders	RCC	HSI enabled	The system clock frequency is 16 MHz using the HSI. This is used only for USARTx bootloaders and during USB detection for DFU bootloader (once the DFU bootloader is selected, the clock source will be derived from the external crystal).
		HSE enabled	The external clock is mandatory only for DFU bootloader and it must be in the following range: [24, 16, 12, 8, 6, 4, 3, 2] MHz. The PLL is used to generate the USB 48 MHz clock and the 32 MHz clock for the system clock.
		-	The Clock Security System (CSS) interrupt is enabled for the DFU bootloader. Any failure (or removal) of the external clock generates system reset.
	IWDG	-	The independent watchdog (IWDG) prescaler is configured to its maximum value and is periodically refreshed to prevent watchdog reset (in case the hardware IWDG option was previously enabled by the user).
	Power	-	Voltage range is set to Voltage Range 1.
	System memory	-	8 Kbyte starting from address 0x1FF0 0000. This area contains the bootloader firmware.
	RAM	-	4 Kbyte starting from address 0x20000000 are used by the bootloader firmware.
USART1 bootloader	USART1	Enabled	Once initialized, the USART1 configuration is: 8 bits, even parity and 1 Stop bit.
	USART1_RX pin	Input	PA10 pin: USART1 in reception mode
	USART1_TX pin	Output	PA9 pin: USART1 in transmission mode
USARTx bootloaders	SysTick timer	Enabled	Used to automatically detect the serial baud rate from the host for USARTx bootloader.

Table 96. STM32L1xxxE configuration in system memory boot mode (continued)

Bootloader	Feature/Peripheral	State	Comment
USART2 bootloader	USART2	Enabled	Once initialized, the USART2 configuration is: 8 bits, even parity and 1 Stop bit. The USART2 uses its remapped pins.
	USART2_RX pin	Input	PD6 pin: USART2 in reception mode
	USART2_TX pin	Output	PD5 pin: USART2 in transmission mode
DFU bootloader	USB	Enabled	USB used in FS mode
	USB_DM pin	Input/Output	PA11: USB DM line.
	USB_DP pin		PA12: USB DP line An external pull-up resistor 1.5 KOhm must be connected to USB_DP pin.

The system clock is derived from the embedded internal high-speed RC for USARTx bootloader. This internal clock is used also for DFU bootloader but only for the selection phase. An external clock in the range of [24, 16, 12, 8, 6, 4, 3, 2] MHz is required for DFU bootloader execution after the selection phase.

44.2 Bootloader selection

The figure below shows the bootloader selection mechanism.

Figure 57. Bootloader selection for STM32L1xxxE devices

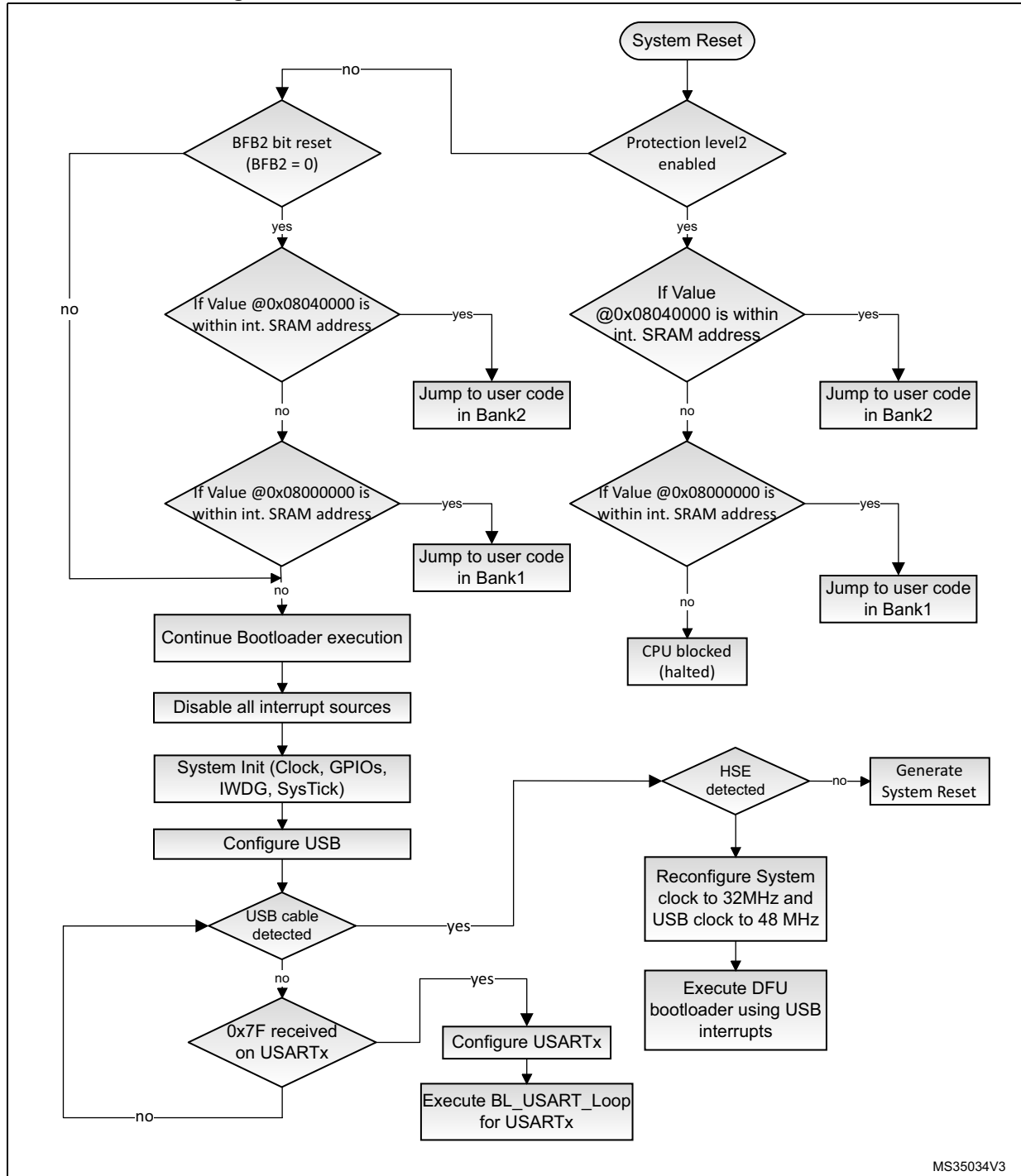

MS35034V3

44.3 Bootloader version

The following table lists the STM32L1xxxE devices bootloader versions:

Table 97. STM32L1xxxE bootloader versions

Bootloader version number	Description	Known limitations
V4.0	Initial bootloader version	For the USART interface, two consecutive NACKs (instead of 1 NACK) are sent when a Read Memory or Write Memory command is sent and the RDP level is active.

45 STM32L43xx/44xx devices bootloader

45.1 Bootloader configuration

The Bootloader V9.1 version is updated to fix known limitations relative to USB-DFU interface, and is implemented on devices with version information ID equal to 0x10 (refer to [Table 99](#) for more details).

The STM32L43xx/44xx bootloader is activated by applying pattern6 (described in [Table 2: Bootloader activation patterns](#)). The following table shows the hardware resources used by this bootloader.

Table 98. STM32L43xx/44xx configuration in System memory boot mode

Bootloader	Feature/Peripheral	State	Comment
Common to all bootloaders	RCC	HSI enabled	The HSI is used at startup as clock source for system clock configured to 60 MHz and for USART, I2C, SPI and USB bootloader operation.
		-	The Clock Recovery System (CRS) is enabled for the DFU bootloader to allow USB to be clocked by HSI 48 MHz.
		HSE enabled	The HSE is used only when the CAN interface is selected. The HSE must have one of the following values [24,20,18,16,12,9,8,6,4] MHz.
		-	The Clock Security System (CSS) interrupt is enabled when HSE is enabled. Any failure (or removal) of the external clock generates system reset
	RAM	-	12 Kbytes starting from address 0x20000000 are used by the bootloader firmware
	System memory	-	28672 bytes starting from address 0x1FFF0000, contain the bootloader firmware
	IWDG	-	The independent watchdog (IWDG) prescaler is configured to its maximum value. It is periodically refreshed to prevent watchdog reset (in case the hardware IWDG option was previously enabled by the user).
	Power	-	The DFU can't be used to communicate with Bootloader if the voltage scaling range 2 is selected. Bootloader firmware doesn't configure voltage scaling range value in PWR_CR1 register.
USART1 bootloader	USART1	Enabled	Once initialized the USART1 configuration is: 8-bits, even parity and 1 Stop bit
	USART1_RX pin	Input	PA10 pin: USART1 in reception mode
	USART1_TX pin	Output	PA9 pin: USART1 in transmission mode

Table 98. STM32L43xx/44xx configuration in System memory boot mode (continued)

Bootloader	Feature/Peripheral	State	Comment
USART2 bootloader	USART2	Enabled	Once initialized the USART2 configuration is: 8-bits, even parity and 1 Stop bit
	USART2_RX pin	Input	PA3 pin: USART2 in reception mode
	USART2_TX pin	Output	PA2 pin: USART2 in transmission mode
USART3 bootloader	USART3	Enabled	Once initialized the USART3 configuration is: 8-bits, even parity and 1 Stop bit
	USART3_RX pin	Input	PC11 pin: USART3 in reception mode
	USART3_TX pin	Output	PC10 pin: USART3 in transmission mode
USARTx bootloaders	SysTick timer	Enabled	Used to automatically detect the serial baud rate from the host for USARTx bootloaders.
I2C1 bootloader	I2C1	Enabled	The I2C1 configuration is: I2C speed: up to 1 MHz, 7-bit address, slave mode, analog filter ON. Slave 7-bit address: 0b1001000x (where x = 0 for write and x = 1 for read)
	I2C1_SCL pin	Input/Output	PB6 pin: clock line is used in open-drain mode.
	I2C1_SDA pin	Input/Output	PB7 pin: data line is used in open-drain mode.
I2C2 bootloader	I2C2	Enabled	The I2C2 configuration is: I2C speed: up to 1 MHz, 7-bit address, slave mode, analog filter ON. Slave 7-bit address: 0b1001000x (where x = 0 for write and x = 1 for read)
	I2C2_SCL pin	Input/Output	PB10 pin: clock line is used in open-drain mode.
	I2C2_SDA pin	Input/Output	PB11 pin: data line is used in open-drain mode.
I2C3 bootloader	I2C3	Enabled	The I2C3 configuration is: I2C speed: up to 1 MHz, 7-bit address, slave mode, analog filter ON. Slave 7-bit address: 0b1001000x (where x = 0 for write and x = 1 for read)
	I2C3_SCL pin	Input/Output	PC0 pin: clock line is used in open-drain mode.
	I2C3_SDA pin	Input/Output	PC1 pin: data line is used in open-drain mode.

Table 98. STM32L43xx/44xx configuration in System memory boot mode (continued)

Bootloader	Feature/Peripheral	State	Comment
SPI1 bootloader	SPI1	Enabled	The SPI1 configuration is: Slave mode, Full Duplex, 8-bit MSB, Speed up to 8 MHz, Polarity: CPOL Low, CPHA Low, NSS hardware.
	SPI1_MOSI pin	Input	PA7 pin: Slave data Input line, used in Push-pull pull-down mode
	SPI1_MISO pin	Output	PA6 pin: Slave data output line, used in Push-pull pull-down mode
	SPI1_SCK pin	Input	PA5 pin: Slave clock line, used in Push-pull pull-down mode
	SPI1_NSS pin	Input	PA4 pin: Slave Chip Select pin used in Push-pull pull-up mode. Note: This IO can be tied to Gnd if the SPI Master does not use it.
SPI2 bootloader	SPI2	Enabled	The SPI2 configuration is: Slave mode, Full Duplex, 8-bit MSB, Speed up to 8 MHz, Polarity: CPOL Low, CPHA Low, NSS hardware.
	SPI2_MOSI pin	Input	PB15 pin: Slave data Input line, used in Push-pull pull-down mode
	SPI2_MISO pin	Output	PB14 pin: Slave data output line, used in Push-pull pull-down mode
	SPI2_SCK pin	Input	PB13 pin: Slave clock line, used in Push-pull pull-down mode
	SPI2_NSS pin	Input	PB12 pin: Slave Chip Select pin used in Push-pull pull-up mode. Note: This IO can be tied to Gnd if the SPI Master does not use it.
CAN1 bootloader	CAN1	Enabled	Once initialized the CAN1 configuration is: Baudrate 125 kbps, 11 -bit identifier.
	CAN1_RX pin	Input	PB8 pin: CAN1 in reception mode
	CAN1_TX pin	Output	PB9 pin: CAN1 in transmission mode
	TIM16	Enabled	This timer is used to determine the value of the HSE. Once the HSE frequency is determined, the system clock is configured to 60 MHz using PLL and HSE.
DFU bootloader	USB	Enabled	USB FS configured in Forced Device mode. USB FS interrupt vector is enabled and used for USB DFU communications. Note: VDDUSB IO must be connected to 3.3V for USB to be operational.
	USB_DM pin	Input/Output	PA11: USB DM line.
	USB_DP pin		PA12: USB DP line No external Pull-up resistor is required

45.2 Bootloader selection

The figure below shows the bootloader selection mechanism.

Figure 58. Bootloader V9.x selection for STM32L43xx/44xx

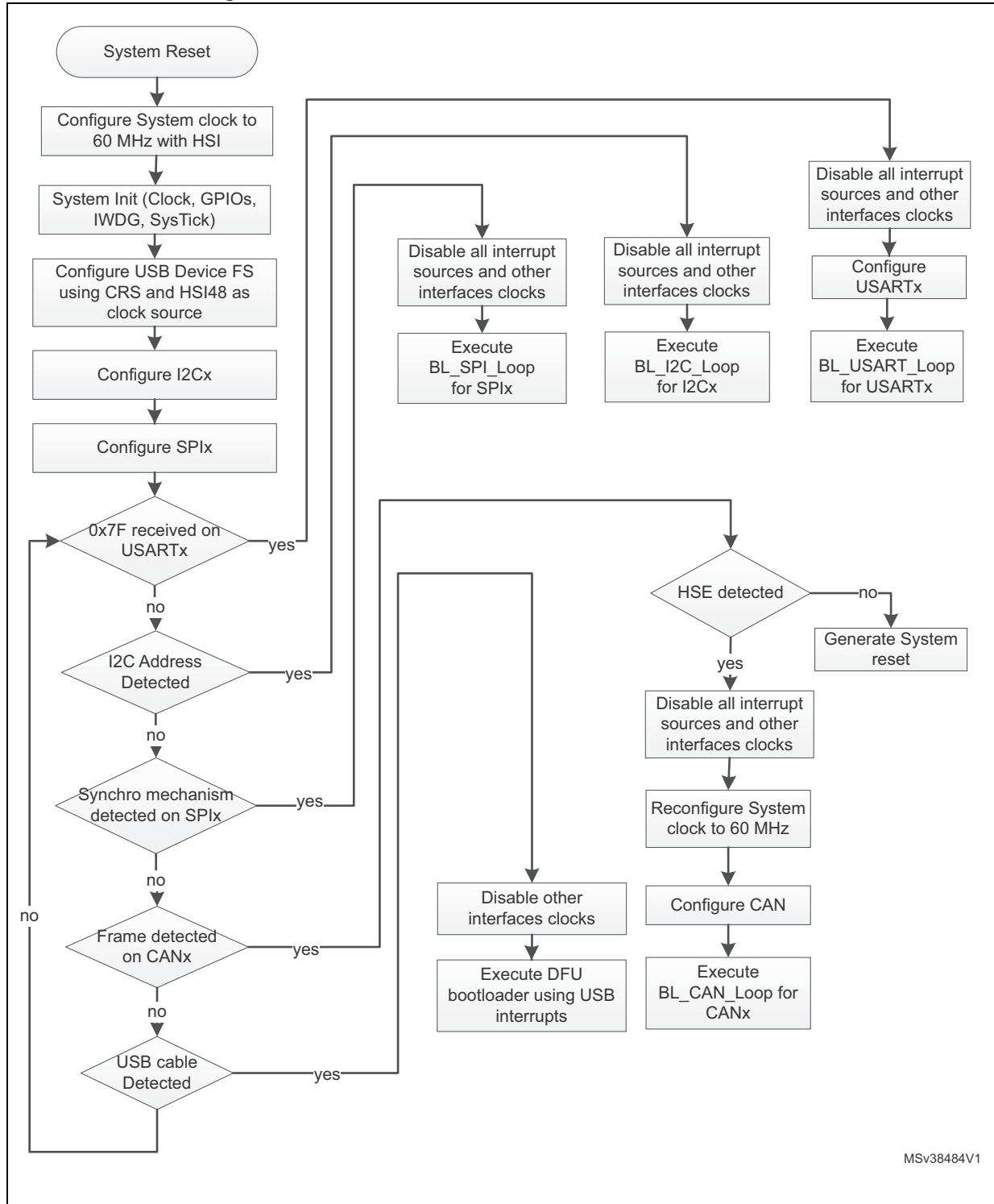

45.3 Bootloader version

The [Table 99](#) lists the STM32L43xx/44xx devices bootloader versions.

Table 99. STM32L43xx/44xx bootloader versions

Bootloader version number	Description	Known limitations
V9.0	Deprecated version (not used)	None
V9.1	Initial bootloader version	<p>For memory write operations using DFU interface: If the buffer size is larger than 256 bytes and not multiple of 8 bytes, the write memory operation result is corrupted. Workaround: if the file size is larger than 256 bytes, add byte padding to align it on 8-bytes multiple size.</p> <p>For the USB-DFU interface, the CRS (Clock Recovery System) is not correctly configured and this may lead to random USB communication errors (depending on temperature and voltage). In most case communication error will manifest by a "Stall" response to setup packets.</p> <p>Note: Above limitations relative to USB-DFU interface apply only to STM32L43xx/44xx devices with a Version Information ID equal to 0xFF.</p> <p>STM32L43xx/44xx devices with a Version Information ID equal to 0x10 are not impacted. Version Information ID can be read at 0x1FFF6FF2 address.</p>

46 STM32L476xx/486xx devices bootloader

Two bootloader versions are available on STM32L476xx/486xx:

- V10.x supporting USART, I2C and DFU (USB FS Device).
This version is embedded in STM32L476xx/486xx rev. 2 and rev. 3 devices.
- V9.x supporting USART, I2C, SPI, CAN and DFU (USB FS Device).
This version is embedded in STM32L476xx/486xx rev. 4 devices.

46.1 Bootloader V10.x

46.1.1 Bootloader configuration

The STM32L476xx/486xx bootloader is activated by applying pattern7 (described in [Table 2: Bootloader activation patterns](#)). The following table shows the hardware resources used by this bootloader.

Table 100. STM32L476xx/486xx configuration in system memory boot mode

Bootloader	Feature/Peripheral	State	Comment
Common to all bootloaders	RCC	HSI enabled	The HSI is used at startup as clock source for system clock configured to 24 MHz and for USART and I2C bootloader operation.
		HSE enabled	The HSE is used only when the USB interface is selected and the LSE is not present. The HSE must have one of the following values [24,20,18,16,12,9,8,6,4] MHz.
		LSE enabled	The LSE is used to trim the MSI which is configured to 48 MHz as USB clock source. The LSE must be equal to 32,768 KHz. If the LSE is not detected, the HSE will be used instead if USB is connected.
		MSI enabled	The MSI is configured to 48 MHz and will be used as USB clock source. The MSI is used only if LSE is detected, otherwise, HSE will be used if USB is connected.
		-	The Clock Security System (CSS) interrupt is enabled when LSE or HSE is enabled. Any failure (or removal) of the external clock generates system reset.
	RAM	-	12 Kbyte starting from address 0x20000000 are used by the bootloader firmware
	System memory	-	28672 byte starting from address 0x1FFF0000, contain the bootloader firmware
	IWDG	-	The independent watchdog (IWDG) prescaler is configured to its maximum value. It is periodically refreshed to prevent watchdog reset (in case the hardware IWDG option was previously enabled by the user).
	Power	-	The DFU can't be used to communicate with Bootloader if the voltage scaling range 2 is selected. Bootloader firmware doesn't configure voltage scaling range value in PWR_CR1 register.

Table 100. STM32L476xx/486xx configuration in system memory boot mode (continued)

Bootloader	Feature/Peripheral	State	Comment
USART1 bootloader	USART1	Enabled	Once initialized the USART1 configuration is: 8-bits, even parity and 1 Stop bit
	USART1_RX pin	Input	PA10 pin: USART1 in reception mode
	USART1_TX pin	Output	PA9 pin: USART1 in transmission mode
USART2 bootloader	USART2	Enabled	Once initialized the USART2 configuration is: 8-bits, even parity and 1 Stop bit
	USART2_RX pin	Input	PA3 pin: USART2 in reception mode
	USART2_TX pin	Output	PA2 pin: USART2 in transmission mode
USART3 bootloader	USART3	Enabled	Once initialized the USART3 configuration is: 8-bits, even parity and 1 Stop bit
	USART3_RX pin	Input	PC11 pin: USART3 in reception mode
	USART3_TX pin	Output	PC10 pin: USART3 in transmission mode
USARTx bootloaders	SysTick timer	Enabled	Used to automatically detect the serial baud rate from the host for USARTx bootloaders.
I2C1 bootloader	I2C1	Enabled	The I2C1 configuration is: I2C speed: up to 400 KHz, 7-bit address, slave mode, analog filter ON. Slave 7-bit address: 0b1000011x (where x = 0 for write and x = 1 for read)
	I2C1_SCL pin	Input/Output	PB6 pin: clock line is used in open-drain mode.
	I2C1_SDA pin	Input/Output	PB7 pin: data line is used in open-drain mode.
I2C2 bootloader	I2C2	Enabled	The I2C2 configuration is: I2C speed: up to 400 KHz, 7-bit address, slave mode, analog filter ON. Slave 7-bit address: 0b1000011x (where x = 0 for write and x = 1 for read)
	I2C2_SCL pin	Input/Output	PB10 pin: clock line is used in open-drain mode.
	I2C2_SDA pin	Input/Output	PB11 pin: data line is used in open-drain mode.
I2C3 bootloader	I2C3	Enabled	The I2C3 configuration is: I2C speed: up to 400 KHz, 7-bit address, slave mode, analog filter ON. Slave 7-bit address is 0b1000011x (where x = 0 for write and x = 1 for read)
	I2C3_SCL pin	Input/Output	PC0 pin: clock line is used in open-drain mode.
	I2C3_SDA pin	Input/Output	PC1 pin: data line is used in open-drain mode.
DFU bootloader	USB	Enabled	USB OTG FS configured in Forced Device mode
	USB_DM pin	Input/Output	PA11: USB DM line.
	USB_DP pin		PA12: USB DP line No external Pull-up resistor is required
	TIM17	Enabled	This timer is used to determine the value of the HSE. Once the HSE frequency is determined, the system clock is configured to 24 MHz using PLL and HSE.

For USARTx and I2Cx bootloaders no external clock is required.

USB bootloader (DFU) requires either an LSE (low-speed external clock) or a HSE (high-speed external clock) :

- In case, the LSE is present regardless the HSE presence, the MSI will be configured and trimmed by the LSE to provide an accurate clock equal to 48 MHz which is the clock source of the USB. The system clock is kept clocked to 24 MHz by the HSI.
- In case, the HSE is present, the system clock and USB clock will be configured respectively to 24 MHz and 48 MHz with HSE as clock source.

46.1.2 Bootloader selection

The [Figure 59](#) and [Figure 60](#) show the bootloader selection mechanism.

Figure 59. Dual Bank Boot Implementation for STM32L476xx/486xx Bootloader V10.x

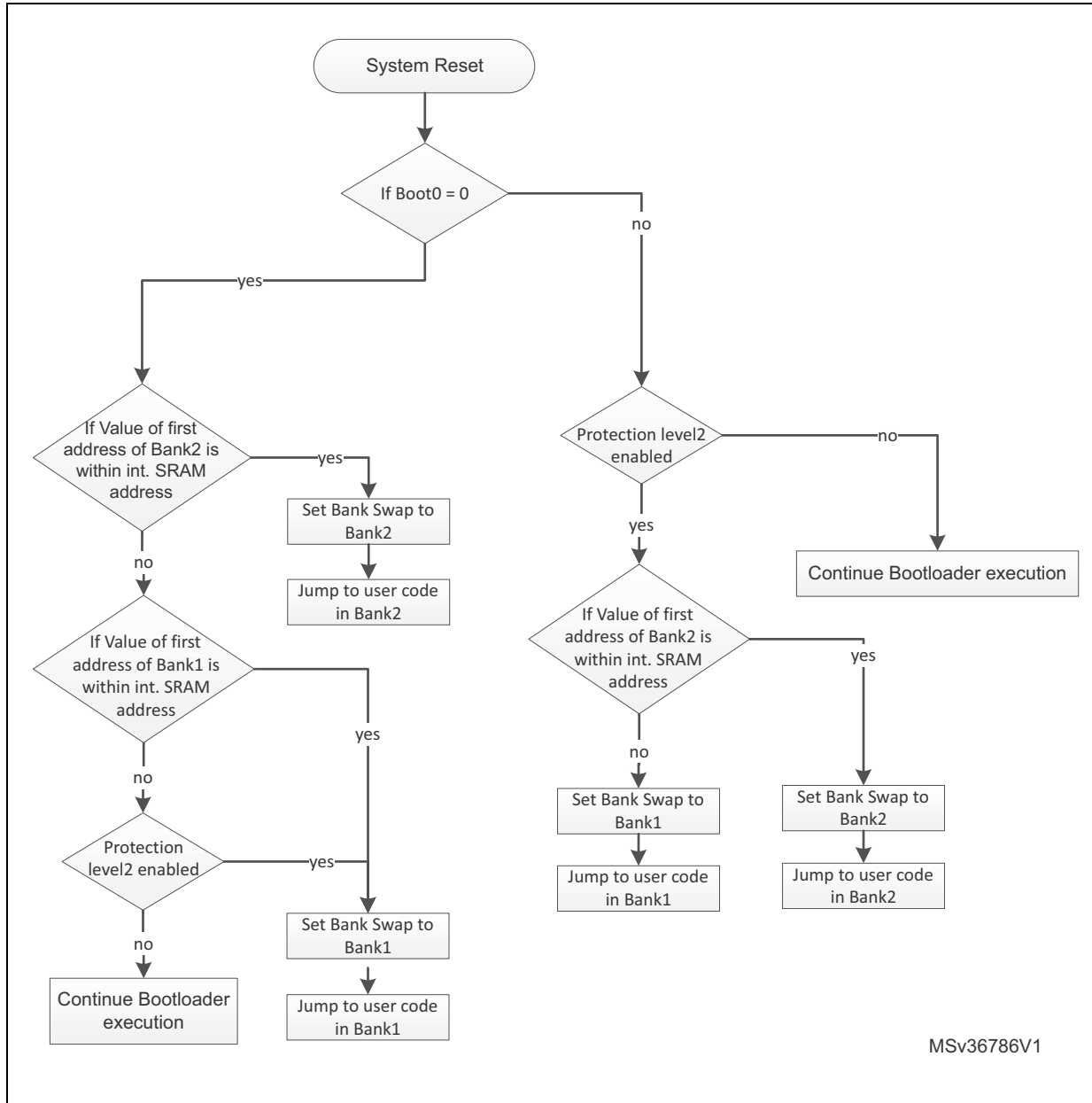
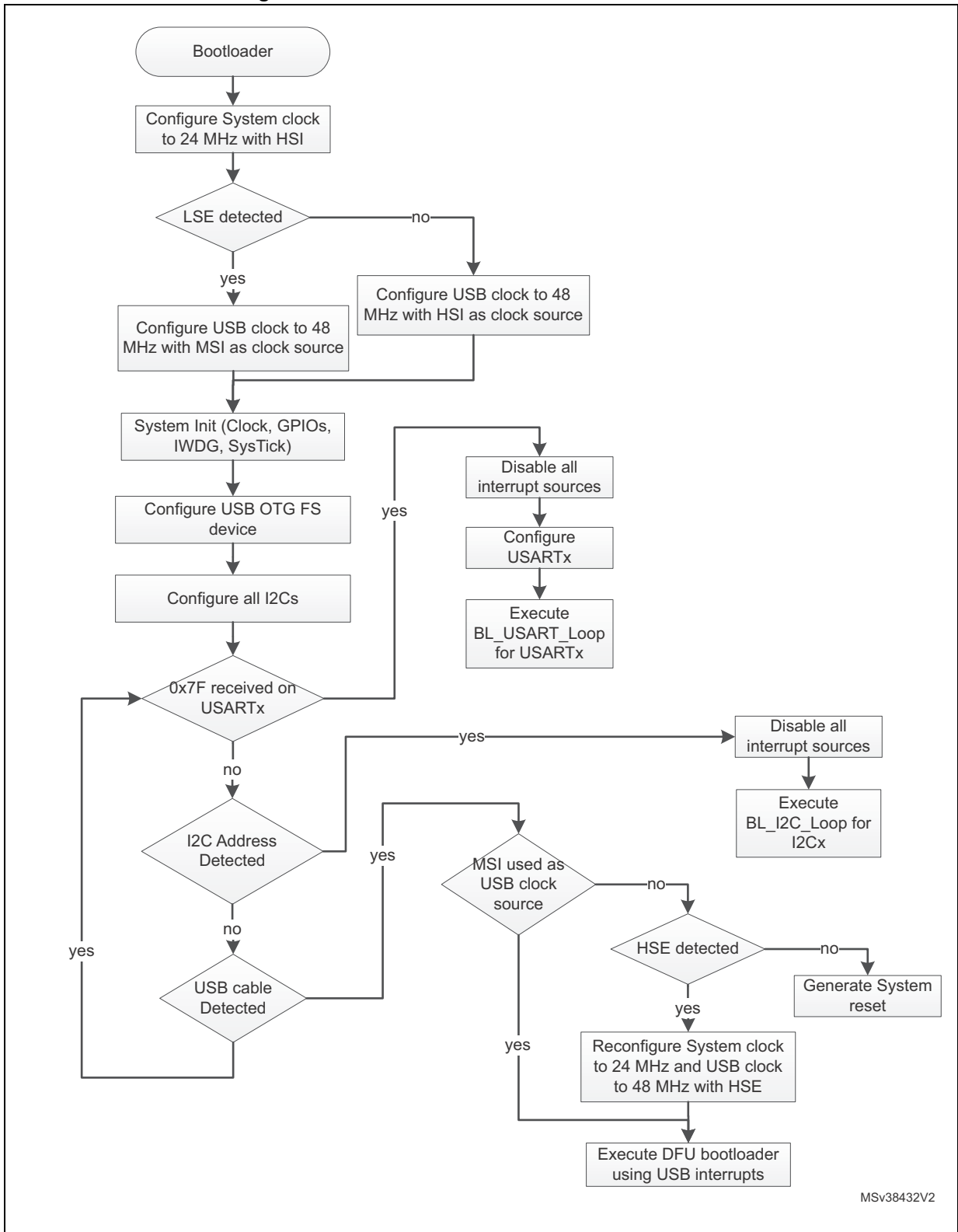

Figure 60.Bootloader V10.x selection for STM32L476xx/486xx



MSv38432V2

46.1.3 Bootloader version

The following table lists the STM32L476xx/486xx devices bootloader V10.x versions:

Table 101. STM32L476xx/486xx bootloader V10.x versions

Bootloader version number	Description	Known limitations
V10.0	Deprecated version (not used)	None
V10.1	Initial bootloader version	For memory write operations using DFU interface: If the buffer size is larger than 256 bytes and not multiple of 8 bytes, the write memory operation result is corrupted. Workaround: if the file size is larger than 256 bytes, add byte padding to align it on 8-bytes multiple size. Write in SRAM is corrupted.
V10.2	Fix write in SRAM issue	For memory write operations using DFU interface: If the buffer size is larger than 256 bytes and not multiple of 8 bytes, the write memory operation result is corrupted. Workaround: if the file size is larger than 256 bytes, add byte padding to align it on 8-bytes multiple size.
V10.3	Add support of MSI as USB clock source (MSI is trimmed by LSE). Update dual bank boot feature to support the case when user stack is mapped in SRAM2.	For memory write operations using DFU interface: If the buffer size is larger than 256 bytes and not multiple of 8 bytes, the write memory operation result is corrupted. Workaround: if the file size is larger than 256 bytes, add byte padding to align it on 8-bytes multiple size.

46.2 Bootloader V9.x

46.2.1 Bootloader configuration

The STM32L476xx/486xx bootloader is activated by applying pattern7 (described in [Table 2: Bootloader activation patterns](#)). The following table shows the hardware resources used by this bootloader.

Table 102. STM32L476xx/486xx configuration in system memory boot mode

Bootloader	Feature/Peripheral	State	Comment
Common to all bootloaders	RCC	HSI enabled	The HSI is used at startup as clock source for system clock configured to 72 MHz and for USART and I2C bootloader operation.
		HSE enabled	The HSE is used only when the USB interface is selected and the LSE is not present. The HSE must have one of the following values [24,20,18,16,12,8,6,4] MHz. System is clocked at 72 MHz if USB is used or 60 MHz if CAN is used.
		LSE enabled	The LSE is used to trim the MSI which is configured to 48 MHz as USB clock source. The LSE must be equal to 32,768 KHz. If the LSE is not detected, the HSE will be used instead if USB is connected.
		MSI enabled	The MSI is configured to 48 MHz and will be used as USB clock source. The MSI is used only if LSE is detected, otherwise, HSE will be used if USB is connected.
		CSS	The Clock Security System (CSS) interrupt is enabled when LSE or HSE is enabled. Any failure (or removal) of the external clock generates system reset.
	RAM	-	12544 byte starting from address 0x20000000 are used by the bootloader firmware
	System memory	-	28672 byte starting from address 0x1FFF0000, contain the bootloader firmware
	IWDG	-	The independent watchdog (IWDG) prescaler is configured to its maximum value. It is periodically refreshed to prevent watchdog reset (in case the hardware IWDG option was previously enabled by the user).
	Power	-	The DFU can't be used to communicate with Bootloader if the voltage scaling range 2 is selected. Bootloader firmware doesn't configure voltage scaling range value in PWR_CR1 register.
USART1 bootloader	USART1	Enabled	Once initialized the USART1 configuration is: 8-bits, even parity and 1 Stop bit
	USART1_RX pin	Input	PA10 pin: USART2 in reception mode
	USART1_TX pin	Output	PA9 pin: USART2 in transmission mode

Table 102. STM32L476xx/486xx configuration in system memory boot mode (continued)

Bootloader	Feature/Peripheral	State	Comment
USART2 bootloader	USART2	Enabled	Once initialized the USART2 configuration is: 8-bits, even parity and 1 Stop bit
	USART2_RX pin	Input	PA3 pin: USART2 in reception mode
	USART2_TX pin	Output	PA2 pin: USART2 in transmission mode
USART3 bootloader	USART3	Enabled	Once initialized the USART3 configuration is: 8-bits, even parity and 1 Stop bit
	USART3_RX pin	Input	PC11 pin: USART3 in reception mode
	USART3_TX pin	Output	PC10 pin: USART3 in transmission mode
USARTx bootloaders	SysTick timer	Enabled	Used to automatically detect the serial baud rate from the host for USARTx bootloaders.
I2C1 bootloader	I2C1	Enabled	The I2C1 configuration is: I2C speed: up to 400 KHz, 7-bit address, slave mode, analog filter ON. Slave 7-bit address: 0b1000011x (where x = 0 for write and x = 1 for read)
	I2C1_SCL pin	Input/Output	PB6 pin: clock line is used in open-drain mode.
	I2C1_SDA pin	Input/Output	PB7 pin: data line is used in open-drain mode.
I2C2 bootloader	I2C2	Enabled	The I2C2 configuration is: I2C speed: up to 400 KHz, 7-bit address, slave mode, analog filter ON. Slave 7-bit address: 0b1000011x (where x = 0 for write and x = 1 for read)
	I2C2_SCL pin	Input/Output	PB10 pin: clock line is used in open-drain mode.
	I2C2_SDA pin	Input/Output	PB11 pin: data line is used in open-drain mode.
I2C3 bootloader	I2C3	Enabled	The I2C3 configuration is: I2C speed: up to 400 KHz, 7-bit address, slave mode, analog filter ON. Slave 7-bit address: 0b1000011x (where x = 0 for write and x = 1 for read)
	I2C3_SCL pin	Input/Output	PC0 pin: clock line is used in open-drain mode.
	I2C3_SDA pin	Input/Output	PC1 pin: data line is used in open-drain mode.
SPI1 bootloader	SPI1	Enabled	The SPI1 configuration is: Slave mode, Full Duplex, 8-bit MSB, Speed up to 8 MHz, Polarity: CPOL Low, CPHA Low, NSS hardware.
	SPI1_MOSI pin	Input	PA7 pin: Slave data Input line, used in Push-pull pull-down mode
	SPI1_MISO pin	Output	PA6 pin: Slave data output line, used in Push-pull pull-down mode
	SPI1_SCK pin	Input	PA5 pin: Slave clock line, used in Push-pull pull-down mode
	SPI1_NSS pin	Input	PA4 pin: Slave Chip Select pin used in Push-pull pull-down mode.



Table 102. STM32L476xx/486xx configuration in system memory boot mode (continued)

Bootloader	Feature/Peripheral	State	Comment
SPI2 bootloader	SPI2	Enabled	The SPI2 configuration is: Slave mode, Full Duplex, 8-bit MSB, Speed up to 8 MHz, Polarity: CPOL Low, CPHA Low, NSS hardware
	SPI2_MOSI pin	Input	PB15 pin: Slave data Input line, used in Push-pull pull-down mode
	SPI2_MISO pin	Output	PB14 pin: Slave data output line, used in Push-pull pull-down mode
	SPI2_SCK pin	Input	PB13 pin: Slave clock line, used in Push-pull pull-down mode
	SPI2_NSS pin	Input	PB12 pin: Slave Chip Select pin used in Push-pull pull-down mode.
CAN1 bootloader	CAN1	Enabled	Once initialized the CAN1 configuration is: Baudrate 125 kbps, 11-bit identifier.
	CAN1_RX pin	Input	PB8 pin: CAN1 in reception mode
	CAN1_TX pin	Output	PB9 pin: CAN1 in transmission mode
DFU bootloader	USB	Enabled	USB FS configured in Forced Device mode. USB FS interrupt vector is enabled and used for USB DFU communications. NOTE: VDDUSB IO must be connected to 3.3V for USB to be operational.
	USB_DM pin	Input/Output	PA11 pin: USB FS DM line
	USB_DP pin		PA12 pin: USB FS DP line. No external Pull-up resistor is required.

In case, the HSE is present, the system clock and USB clock will be configured respectively to 72 MHz and 48 MHz with PLL (clocked by HSE) as a clock source.

46.2.2 Bootloader selection

The *Figure 61* and *Figure 62* show the bootloader selection mechanism.

Figure 61. Dual Bank Boot Implementation for STM32L476xx/486xx Bootloader V9.x

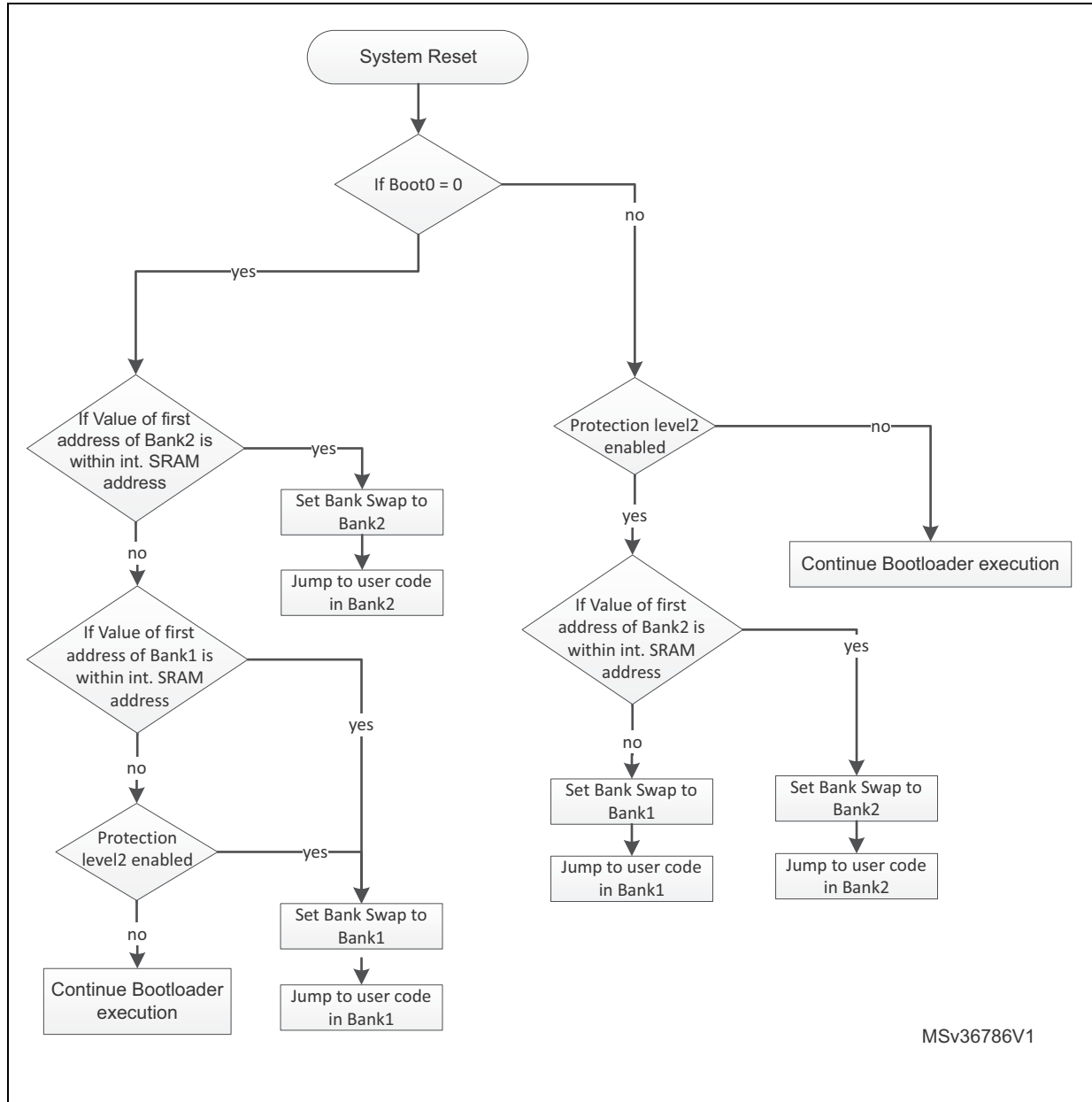
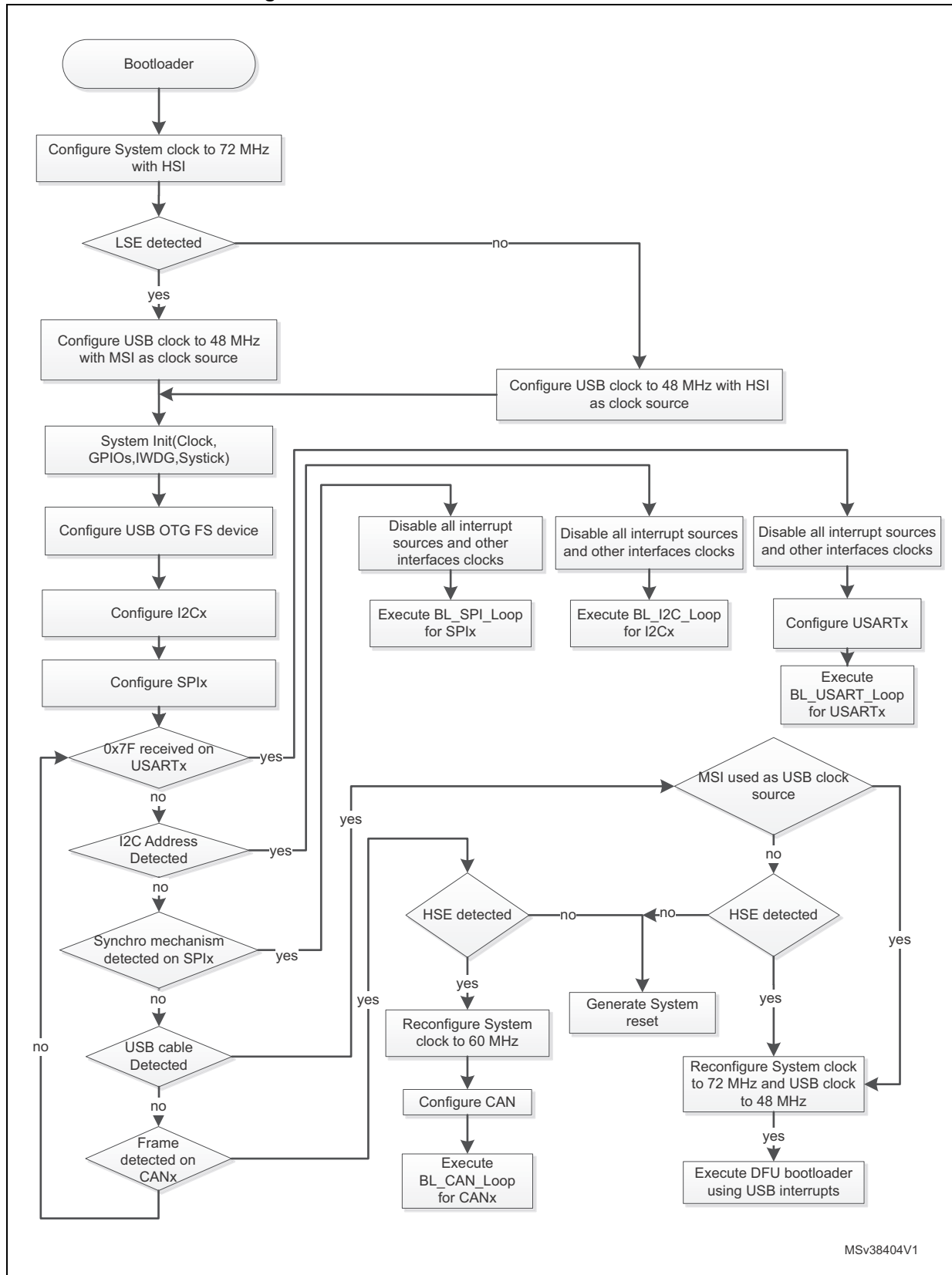

Figure 62.Bootloader V9.x selection for STM32L476xx/486xx



MSv38404V1

46.2.3 Bootloader version

The following table lists the STM32L476xx/486xx devices bootloader V9.x versions:

Table 103. STM32L476xx/486xx bootloader V9.x versions

Bootloader version number	Description	Known limitations
V9.0	Initial bootloader version	For memory write operations using DFU interface: If the buffer size is larger than 256 bytes and not multiple of 8 bytes, the write memory operation result is corrupted. Workaround: if the file size is larger than 256 bytes, add byte padding to align it on 8-bytes multiple size. Write in SRAM is corrupted
V9.1	Deprecated version (not used)	None
V9.2	Fix write in SRAM issue	For memory write operations using DFU interface: If the buffer size is larger than 256 bytes and not multiple of 8 bytes, the write memory operation result is corrupted. Workaround: if the file size is larger than 256 bytes, add byte padding to align it on 8-bytes multiple size.

47 Device-dependent bootloader parameters

The bootloader protocol's command set and sequences for each serial peripheral are the same for all STM32 devices. However, some parameters depend on device and bootloader version:

- PID (Product ID)
- Valid RAM memory addresses (RAM area used during bootloader execution is not accessible) accepted by the bootloader when the Read Memory, Go and Write Memory commands are requested.
- System Memory area.

The table below shows the values of these parameters for each STM32 device bootloader in production.

Table 104. Bootloader device-dependent parameters

STM32 series	Device	PID	BL ID	RAM memory	System memory
F0	STM32F05xxx and STM32F030x8 devices	0x440	0x21	0x20000800 - 0x20001FFF	0x1FFFE000 - 0x1FFFF7FF
	STM32F03xx4/6	0x444	0x10	0x20000800 - 0x20000FFF	
	STM32F030xC	0x442	0x52	0x20001800 - 0x20007FFF	0x1FFFD800 - 0x1FFFF7FF
	STM32F04xxx	0x445	0xA0	NA	0x1FFFC400 - 0x1FFFF7FF
	STM32F070x6	0x445	0xA2	NA	0x1FFFC400 - 0x1FFFF7FF
	STM32F070xB	0x448	0xA2	NA	0x1FFFC800 - 0x1FFFF7FF
	STM32F071xx/72xx	0x448	0xA1	0x20001800 - 0x20003FFF	0x1FFFC800 - 0x1FFFF7FF
	STM32F09xxx	0x442	0x50	NA	0x1FFFD800 - 0x1FFFF7FF
F1	STM32F10xxx	Low-density	0x412	NA	0x1FFFF000 - 0x1FFFF7FF
		Medium-density	0x410	NA	
		High-density	0x414	NA	
		Medium-density value line	0x420	0x10	
		High-density value line	0x428	0x10	
	STM32F105xx/107xx	0x418	NA	0x20001000 - 0x2000FFFF	0x1FFFB000 - 0x1FFFF7FF
	STM32F10xxx XL-density	0x430	0x21	0x20000800 - 0x20017FFF	0x1FFFE000 - 0x1FFFF7FF
F2	STM32F2xxxx	0x411	0x20	0x20002000 - 0x2001FFFF	0x1FFF0000 - 0x1FFF77FF
	0x33				

Table 104. Bootloader device-dependent parameters (continued)

STM32 series	Device	PID	BL ID	RAM memory	System memory
F3	STM32F373xx	0x432	0x41	0x20001400 - 0x20007FFF	0x1FFFD800 - 0x1FFFF7FF
	STM32F378xx		0x50	0x20001000 - 0x20007FFF	
	STM32F302xB(C)/303xB(C)	0x422	0x41	0x20001400 - 0x20009FFF	
	STM32F358xx		0x50		
	STM32F301xx/302x4(6/8)	0x439	0x40	0x20001800 - 0x20003FFF	
	STM32F318xx		0x50		
	STM32F303x4(6/8)/334xx/328xx	0x438	0x50	0x20001800 - 0x20002FFF	
	STM32F302xD(E)/303xD(E)	0x446	0x40	0x20001800 - 0x2000FFFF	
STM32F398xx	0x446	0x50	0x20001800 - 0x2000FFFF		
F4	STM32F40xxx/41xxx	0x413	0x31	0x20002000 - 0x2001FFFF	0x1FFF0000 - 0x1FFF77FF
			0x90	0x20003000 - 0x2001FFFF	
	STM32F42xxx/43xxx	0x419	0x70	0x20003000 - 0x2002FFFF	
			0x90		
	STM32F401xB(C)	0x423	0xD1	0x20003000 - 0x2000FFFF	
	STM32F401xD(E)	0x433	0xD1	0x20003000 - 0x20017FFF	
	STM32F410xx	0x458	0xB1	0x20003000 - 0x20007FFF	
	STM32F411xx	0x431	0xD0	0x20003000 - 0x2001FFFF	
STM32F412xx	0x441	0x90	0x20003000 - 0x2003FFFF		
STM32F446xx	0x421	0x90	0x20003000 - 0x2001FFFF		
STM32F469xx/479xx	0x434	0x90	0x20003000 - 0x2005FFFF		
F7	STM32F74xxx/75xxx	0x449	0x70	0x20004000 - 0x2004FFFF	0x1FF00000 - 0x1FF0EDBF
			0x90	0x20004000 - 0x2004FFFF	0x1FF00000 - 0x1FF0EDBF
STM32F76xxx/77xxx	0x451	0x93	0x20004000 - 0x2007FFFF	0x1FF00000 - 0x1FF0EDBF	
L0	STM32L01xxx/02xxx	0x457	0xC3	NA	0x1FF00000 - 0x1FF00FFF
	STM32L031xx/041xx	0x425	0xC0	0x20001000 - 0x20002000	0x1FF00000 - 0x1FF00FFF
	STM32L05xxx/06xxx	0x417	0xC0	0x20001000 - 0x20001FFF	0x1FF00000 - 0x1FF00FFF
	STM32L07xxx/08xxx	0x447	0x41	0x20001000 - 0x20004FFF	0x1FF00000 - 0x1FF01FFF
0xB2			0x20001400 - 0x20004FFF		
L1	STM32L1xxx6(8/B)	0x416	0x20	0x20000800 - 0x20003FFF	0x1FF00000 - 0x1FF01FFF
	STM32L1xxx6(8/B)A	0x429	0x20	0x20001000 - 0x20007FFF	
	STM32L1xxxC	0x427	0x40		
	STM32L1xxxD	0x436	0x45	0x20001000 - 0x2000BFFF	
	STM32L1xxxE	0x437	0x40	0x20001000 - 0x20013FFF	

Table 104. Bootloader device-dependent parameters (continued)

STM32 series	Device	PID	BL ID	RAM memory	System memory
L4	STM32L43xx/44xx	0x435	0x91	0x20003100 - 0x2000C000	0x1FFF0000 - 0x1FFF6FFF
	STM32L476xx/486xx	0x415	0xA3	0x20003000 - 0x20017FFF	0x1FFF0000 - 0x1FFF6FFF
			0x92	0x20003100 - 0x20017FFF	

48 Bootloader timing

This section presents the typical timings of the bootloader firmware that should be used to ensure correct synchronization between host and STM32 device.

Two types of timings will be described herein:

- STM32 device bootloader resources initialization duration.
- Communication interface selection duration.

After these timings the bootloader is ready to receive and execute host commands.

48.1 Bootloader Startup timing

After bootloader reset, the host should wait until the STM32 bootloader is ready to start detection phase with a specific interface communication. This time corresponds to bootloader startup timing, during which resources used by bootloader are initialized.

Figure 63. Bootloader Startup timing description

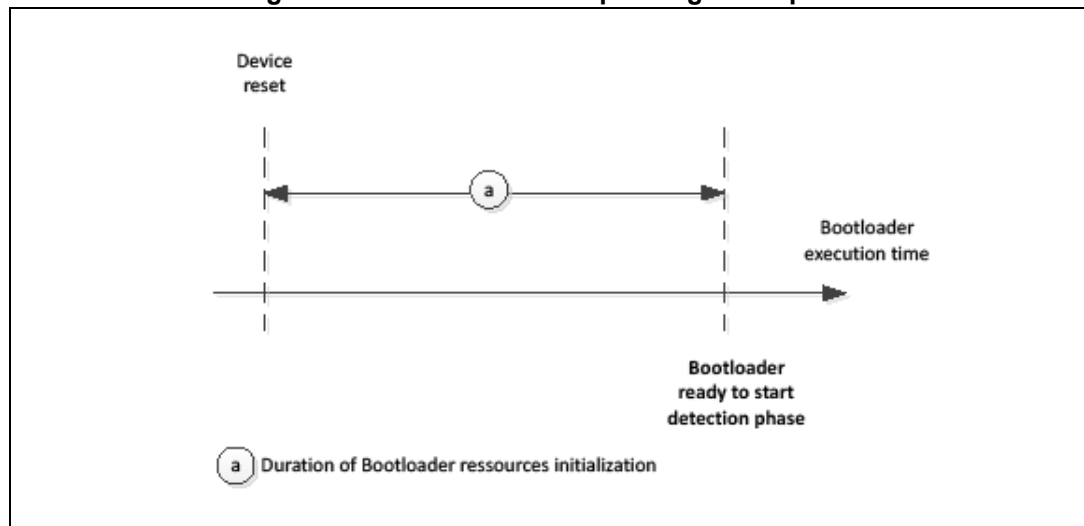

The table below contains the minimum startup timing for each STM32 product:

Table 105. Bootloader startup timings of STM32 devices

Device	Minimum bootloader Startup (ms)	HSE Timeout (ms)
STM32F03xx4/6	1.612	NA
STM32F05xxx and STM32F030x8 devices	1.612	NA
STM32F04xxx	0.058	NA
STM32F071xx/72xx	0.058	NA
STM32F070x6	HSE connected	3
	HSE not connected	230
		200

Table 105. Bootloader startup timings of STM32 devices (continued)

Device		Minimum bootloader Startup (ms)	HSE Timeout (ms)
STM32F070xB	HSE connected	6	200
	HSE not connected	230	
STM32F09xxx		2	NA
STM32F10xxx		1.227	NA
STM32F105xx/107xx	PA9 pin low	1.396	NA
	PA9 pin high	524.376	
STM32F10xxx XL-density		1.227	NA
STM32F2xxxx	V2.x	134	NA
	V3.x	84.59	0.790
STM32F301xx/302x4(6/8)	HSE connected	45	560.5
	HSE not connected	560.8	
STM32F302xB(C)/303xB(C)	HSE connected	43.4	2.236
	HSE not connected	2.36	
STM32F302xD(E)/303xD	HSE connected	7.53	NA
	HSE not connected	146.71	NA
STM32F303x4(6/8)/334xx/328xx		0.155	NA
STM32F318xx		0.182	NA
STM32F358xx		1.542	NA
STM32F373xx	HSE connected	43.4	2.236
	HSE not connected	2.36	
STM32F378xx		1.542	NA
STM32F398xx		1.72	NA
STM32F40xxx/41xxx	V3.x	84.59	0.790
	V9.x	74	96
STM32F401xB(C)		74.5	85
STM32F401xD(E)		74.5	85
STM32F410xx		0.614	NA
STM32F411xx		74.5	85
STM32F412xx		0.614	180
STM32F429xx/439xx	V7.x	82	97
	V9.x	74	97
STM32F446xx		73.61	96
STM32F469xx/479xx		73.68	230

Table 105. Bootloader startup timings of STM32 devices (continued)

Device		Minimum bootloader Startup (ms)	HSE Timeout (ms)
STM32F74xxx/75xxx		16.63	50
STM32L01xxx/02xxx		0.63	NA
STM32L031xx/041xx		0.62	NA
STM32L05xxx/06xxx		0.22	NA
STM32L07xxx/08xxx	V4.x	0.61	NA
	V11.x	0.71	NA
STM32L1xxx6(8/B)A		0.542	NA
STM32L1xxx6(8/B)		0.542	NA
STM32L1xxxC		0.708	80
STM32L1xxxD		0.708	80
STM32L1xxxE		0.708	200
STM32L476xx/486xx	V10.x	LSE Connected	55
		LSE Not Connected	2560
	V9.x	LSE connected	55,40
		LSE not connected	2560,51

48.2 USART connection timing

USART connection timing is the time that the host should wait for between sending the synchronization data (0x7F) and receiving the first acknowledge response (0x79).

Figure 64. USART connection timing description

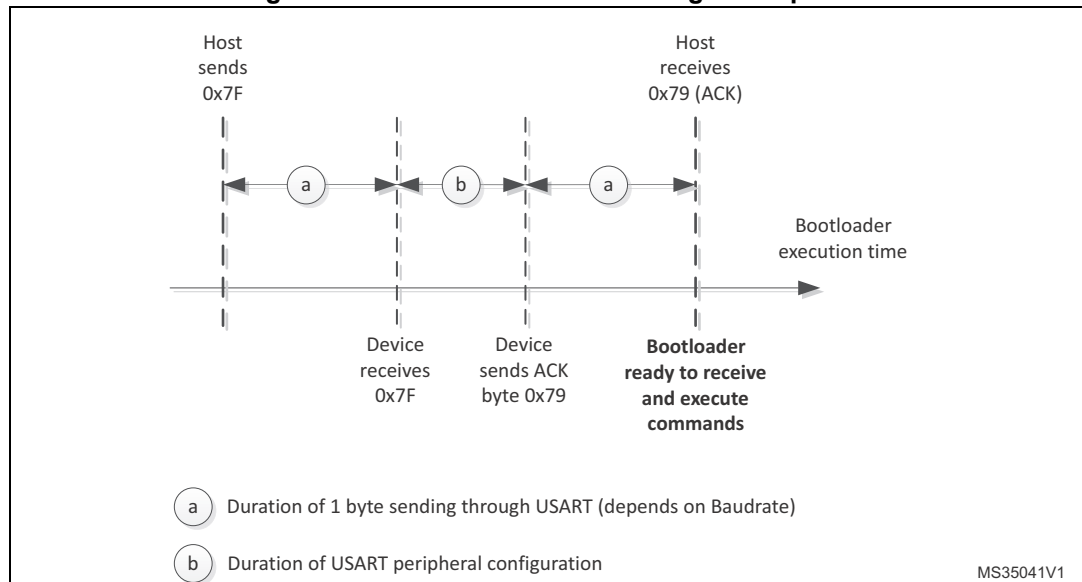

1. Receiving any other character different from 0x7F (or line glitches) will cause Bootloader to start communication using a wrong baudrate. Bootloader measures the signal length between rising edge of first 1 bit in 0x7F to the falling edge of the last 1 bit in 0x7F to deduce the baudrate value
2. Bootloader does not re-align the calculated baudrate to standard baudrate values (ie. 1200, 9600, 115200, ...).

Note: For STM32F105xx/107xx line devices, PA9 pin (USB_VBUS) is used to detect the USB host connection. The initialization of USB peripheral is performed only if PA9 is high at detection phase which means that a host is connected to the port and delivering 5 V on the USB bus. When PA9 level is high at detection phase, more time is required to initialize and shutdown the USB peripheral. To minimize bootloader detection time when PA9 pin is not used, keep PA9 state low during USART detection phase from the moment the device is reset till a device ACK is sent.

Table 106. USART bootloader minimum timings of STM32 devices

Device	One USART byte sending (ms)	USART configuration (ms)	USART connection (ms)
STM32F03xx4/6	0.078125	0.0064	0.16265
STM32F05xxx and STM32F030x8 devices	0.078125	0.0095	0.16575
STM32F04xxx	0.078125	0.007	0.16325
STM32F071xx/72xx	0.078125	0.007	0.16325
STM32F070x6	0.078125	0.014	0.17
STM32F070xB	0.078125	0.08	0.23

Table 106. USART bootloader minimum timings of STM32 devices (continued)

Device		One USART byte sending (ms)	USART configuration (ms)	USART connection (ms)
STM32F09xxx		0.078125	0.07	0.22
STM32F10xxx		0.078125	0.002	0.15825
STM32F105xx/107xx	PA9 pin low	0.078125	0.007	0.16325
	PA9 pin High		105	105.15625
STM32F10xxx XL-density		0.078125	0.006	0.16225
STM32F2xxxx	V2.x	0.078125	0.009	0.16525
	V3.x			
STM32F301xx/302x4(6/8)	HSE connected	0.078125	0.002	0.15825
	HSE not connected			
STM32F302xB(C)/303xB(C)	HSE connected	0.078125	0.002	0.15825
	HSE not connected			
STM32F302xD(E)/303xD		0.078125	0.002	0.15885
STM32F303x4(6/8)/334xx/328xx		0.078125	0.002	0.15825
STM32F318xx		0.078125	0.002	0.15825
STM32F358xx		0.15625	0.001	0.3135
STM32F373xx	HSE connected	0.078125	0.002	0.15825
	HSE not connected			
STM32F378xx		0.15625	0.001	0.3135
STM32F398xx		0.078125	0.002	0.15885
STM32F40xxx/41xxx	V3.x	0.078125	0.009	0.16525
	V9.x		0.0035	0.15975
STM32F401xB(C)		0.078125	0.00326	0.15951
STM32F401xD(E)		0.078125	0.00326	0.15951
STM32F410xx		0.078125	0.002	0.158
STM32F411xx		0.078125	0.00326	0.15951
STM32F412xx		0.078125	0.002	0.158
STM32F429xx/439xx	V7.x	0.078125	0.007	0.16325
	V9.x		0.00326	0.15951
STM32F446xx		0.078125	0.004	0.16
STM32F469xx/479xx		0.078125	0.003	0.159
STM32F74xxx/75xxx		0.078125	0.065	0.22
STM32L01xxx/02xxx		0.078125	0.016	0.17
STM32L031xx/041xx		0.078125	0.018	0.174

Table 106. USART bootloader minimum timings of STM32 devices (continued)

Device		One USART byte sending (ms)	USART configuration (ms)	USART connection (ms)
STM32L05xxx/06xxx		0.078125	0.018	0.17425
STM32L07xxx/08xxx	V4.x	0.078125	0.017	0.173
	V11.x	0.078125	0.017	0.158
STM32L1xxx6(8/B)A		0.078125	0.008	0.16425
STM32L1xxx6(8/B)		0.078125	0.008	0.16425
STM32L1xxxC		0.078125	0.008	0.16425
STM32L1xxxD		0.078125	0.008	0.16425
STM32L1xxxE		0.078125	0.008	0.16425
STM32L476xx/486xx	V10.x	0.078125	0.003	0.159
	V9.x	0.078125	0.003	0.159

48.3 USB connection timing

USB connection timing is the time that the host should wait for between plugging the USB cable and establishing a correct connection with the device. This timing includes enumeration and DFU components configuration. USB connection depends on the host.

Figure 65. USB connection timing description

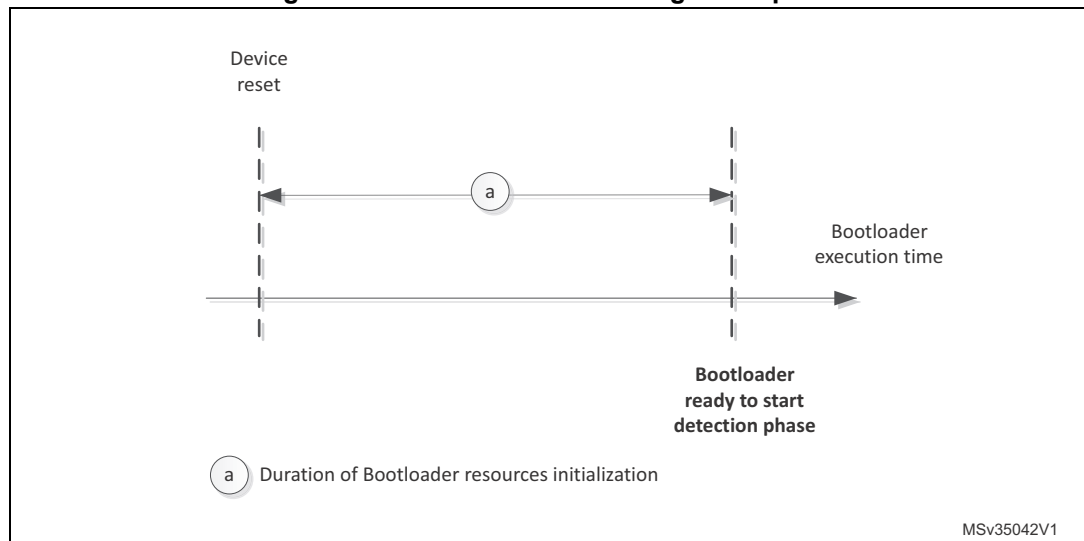

Note: For STM32F105xx/107xx devices, if the external HSE crystal frequency is different from 25 MHz (14.7456 MHz or 8 MHz), the device performs several unsuccessful enumerations (with connect – disconnect sequences) before being able to establish a correct connection with the host. This is due to the HSE automatic detection mechanism based on Start Of Frame (SOF) detection.

Table 107. USB bootloader minimum timings of STM32 devices

Device		USB connection (ms)
STM32F04xxx		350
STM32F070x6		TBD
STM32F070xB		320
STM32F105xx/107xx	HSE = 25 MHz	460
	HSE = 14.7465 MHz	4500
	HSE = 8 MHz	13700
STM32F2xxxx		270
STM32F301xx/302x4(6/8)		300
STM32F302xB(C)/303xB(C)		300
STM32F302xD(E)/303xD		100
STM32F373xx		300
STM32F40xxx/41xxx	V3.x	270
	V9.x	250
STM32F401xB(C)		250
STM32F401xD(E)		250
STM32F411xx		250
STM32F412xx		380
STM32F429xx/439xx	V7.x	250
	V9.x	250
STM32F446xx		200
STM32F469xx/479xx		270
STM32F74xxx/75xxx		230
STM32L07xxx/08xxx		140
STM32L1xxxC		849
STM32L1xxxD		849
STM32L476xx/486xx	V10.x	300
	V9.x	

48.4 I2C connection timing

I2C connection timing is the time that the host should wait for between sending I2C device address and sending command code. This timing includes I2C line stretching duration.

Figure 66. I2C connection timing description

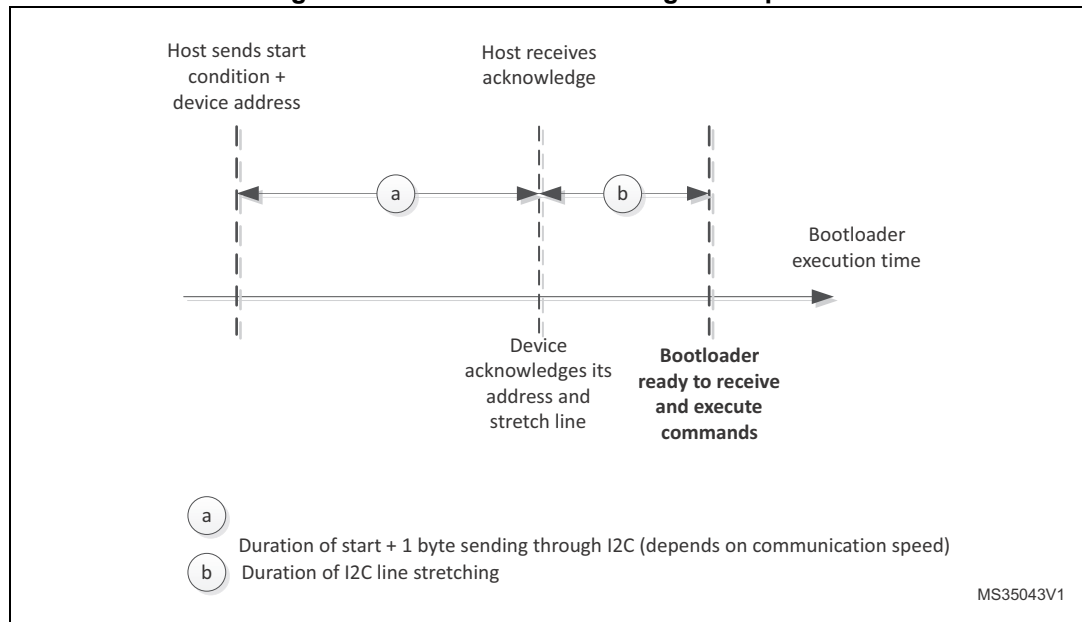

Note: For I2C communication, a timeout mechanism is implemented and it must be respected to execute bootloader commands correctly. This timeout is implemented between two I2C frames in the same command (eg: for Write memory command a timeout is inserted between command sending frame and address memory sending frame). Also the same timeout period is inserted between two successive data reception or transmission in the same I2C frame. If the timeout period is elapsed a system reset is generated to avoid bootloader crash.

In erase memory command and read-out unprotect command, the duration of flash operation should be taken into consideration when implementing the host side. After sending the code of pages to be erased, the host should wait until the bootloader device performs page erasing to complete the remaining steps of erase command.

Table 108. I2C bootloader minimum timings of STM32 devices

Device	Start condition + one I2C byte sending (ms)	I2C line stretching (ms)	I2C connection (ms)	I2C Timeout (ms)
STM32F04xxx	0.0225	0.0025	0.025	1000
STM32F071xx/72xx	0.0225	0.0025	0.025	1000
STM32F070x6	0.0225	0.002	0.245	1000
STM32F070xB	0.0225	0.002	0.245	1000
STM32F09xxx	0.0225	0.002	0.245	1000
STM32F410xx	0.0225	0.002	0.245	1000

Table 108. I2C bootloader minimum timings of STM32 devices (continued)

Device	Start condition + one I2C byte sending (ms)	I2C line stretching (ms)	I2C connection (ms)	I2C Timeout (ms)
STM32F469xx/479xx	0.0225	0.002	0.245	1000
STM32F74xxx/75xxx	0.0225	0.002	0.245	500
STM32F303x4(6/8)/334xx/328xx	0.0225	0.0027	0.0252	1000
STM32F318xx	0.0225	0.0027	0.0252	1000
STM32F358xx	0.0225	0.0055	0.028	10
STM32F378xx	0.0225	0.0055	0.028	10
STM32F398xx	0.0225	0.0020	0.245	1500
STM32F40xxx/41xxx	0.0225	0.0022	0.0247	1000
STM32F401xB(C)	0.0225	0.0022	0.0247	1000
STM32F401xD(E)	0.0225	0.0022	0.0247	1000
STM32F411xx	0.0225	0.0022	0.0247	1000
STM32F412xx	0.0225	0.0020	0.245	1000
STM32F429xx/439xx	V7.x	0.0225	0.0033	1000
	V9.x		0.0022	
STM32F446xx	0.0225	0.002	0.245	1000
STM32L07xxx/08xxx	0.0225	0.002	0.245	1000
STM32L476xx/486xx	V10.x	0.0225	0.002	1000
	V9.x	0.0225	0.002	1000

48.5 SPI connection timing

SPI connection timing is the time that the host should wait for between sending the synchronization data (0xA5) and receiving the first acknowledge response (0x79).

Figure 67. SPI connection timing description

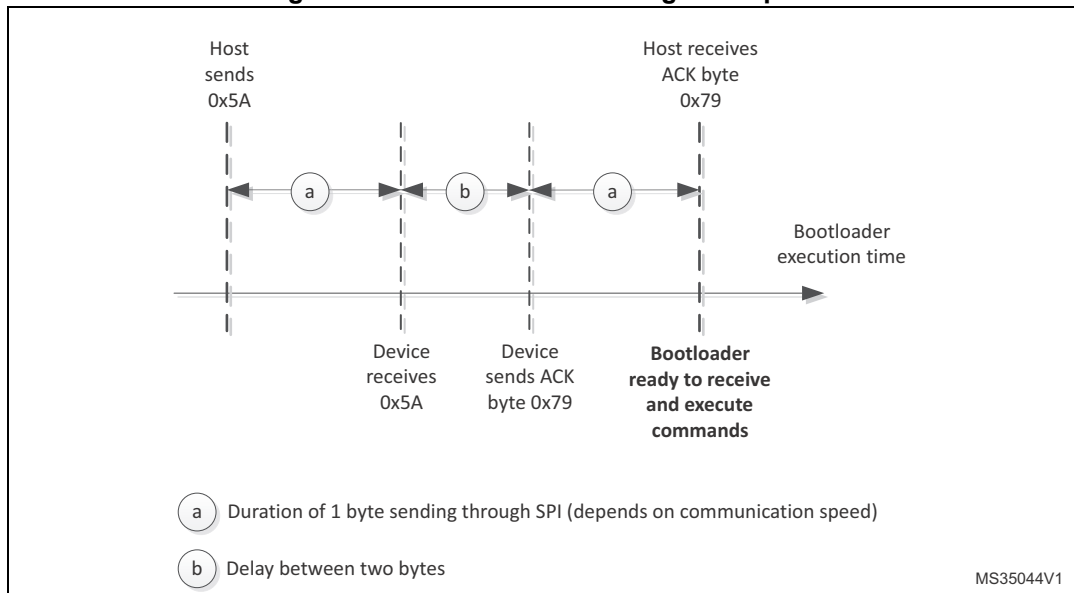

Table 109. SPI bootloader minimum timings of STM32 devices

Device	One SPI byte sending (ms)	Delay between two bytes(ms)	SPI connection (ms)
All products	0.001	0.008	0.01

49 Revision history

Table 110. Document revision history

Date	Revision	Changes
22-Oct-2007	1	Initial release.
22-Jan-2008	2	<p>All STM32 in production (rev. B and rev. Z) include the bootloader described in this application note.</p> <p>Modified: Section 3.1: Bootloader activation and Section 1.4: Bootloader code sequence.</p> <p>Added: Section 1.3: Hardware requirements, Section 1.5: Choosing the USART baud rate, Section 1.6: Using the bootloader and Section: Note 2 linked to Get, Get Version & Read Protection Status and Get ID commands in Table 3: Bootloader commands, Note 3 added.</p> <p>Notion of “permanent” (Permanent Write Unprotect/Readout Protect/Unprotect) removed from document. Small text changes.</p> <p>Bootloader version upgraded to 2.0.</p>
26-May-2008	3	<p>Small text changes. RAM and System memory added to Table : The system clock is derived from the embedded internal high-speed RC, no external quartz is required for the bootloader execution.</p> <p>Section 1.6: Using the bootloader on page 8 removed.</p> <p>Erase modified, Note 3 modified and Note 1 added in Table 3: Bootloader commands on page 9.</p> <p>Byte 3: on page 11 modified.</p> <p>Byte 2: on page 13 modified.</p> <p>Byte 2; Bytes 3-4: and Byte 5: on page 15 modified, Note 3 modified.</p> <p>Byte 8: on page 18 modified.</p> <p>Notes added to Section 2.5: Go command on page 18.</p> <p>Figure 11: Go command: device side on page 20 modified.</p> <p>Note added in Section 2.6: Write Memory command on page 21.</p> <p>Byte 8: on page 24 modified.</p> <p>Figure 14: Erase Memory command: host side and Figure 15: Erase Memory command: device side modified.</p> <p>Byte 3: on page 26 modified.</p> <p>Table 3: Bootloader commands on page 9.</p> <p>Note modified and note added in Section 2.8: Write Protect command on page 27.</p> <p>Figure 16: Write Protect command: host side, Figure 17: Write Protect command: device side, Figure 19: Write Unprotect command: device side, Figure 21: Readout Protect command: device side and Figure 23: Readout Unprotect command: device side modified.</p>
29-Jan-2009	4	<p>This application note also applies to the STM32F102xx microcontrollers.</p> <p>Bootloader version updated to V2.2 (see Table 4: Bootloader versions).</p>

Table 110. Document revision history (continued)

Date	Revision	Changes
19-Nov-2009	5	<p>IWDG added to Table : The system clock is derived from the embedded internal high-speed RC, no external quartz is required for the bootloader execution. Note added.</p> <p>BL changed bootloader in the entire document.</p> <p>Go command description modified in Table : The system clock is derived from the embedded internal high-speed RC, no external quartz is required for the bootloader execution.</p> <p>Number of bytes awaited by the bootloader corrected in Section 2.4: Read Memory command.</p> <p>Note modified below Figure 10: Go command: host side.</p> <p>Note removed in Section 2.5: Go command and note added.</p> <p>Start RAM address specified and note added in Section 2.6: Write Memory command. All options are erased when a Write Memory command is issued to the Option byte area.</p> <p>Figure 11: Go command: device side modified.</p> <p>Figure 13: Write Memory command: device side modified.</p> <p>Note added and bytes 3 and 4 sent by the host modified in Section 2.7: Erase Memory command.</p> <p>Note added to Section 2.8: Write Protect command.</p>
09-Mar-2010	6	<p>Application note restructured. Value line and connectivity line device bootloader added (Replaces AN2662).</p> <p>Introduction changed. Glossary added.</p>
20-Apr-2010	7	<p>Related documents: added XL-density line datasheets and programming manual.</p> <p>Glossary: added XL-density line devices.</p> <p>Table 3: added information for XL-density line devices.</p> <p>Section 4.1: Bootloader configuration: updated first sentence.</p> <p>Section 5.1: Bootloader configuration: updated first sentence.</p> <p>Added Section 6: STM32F10xxx XL-density devices bootloader.</p> <p>Table 65: added information for XL-density line devices.</p>
08-Oct-2010	8	<p>Added information for high-density value line devices in Table 3 and Table 65.</p>
14-Oct-2010	9	<p>Removed references to obsolete devices.</p>
26-Nov-2010	10	<p>Added information on ultralow power devices.</p>
13-Apr-2011	11	<p>Added information related to STM32F205/215xx and STM32F207/217xx devices.</p> <p>Added Section 32: Bootloader timing</p>
06-Jun-2011	12	<p>Updated:</p> <ul style="list-style-type: none"> – Table 12: STM32L1xxx6(8/B) bootloader versions – Table 17: STM32F2xxxx configuration in System memory boot mode – Table 18: STM32F2xxxx bootloader V2.x versions – Table 20: STM32F2xxxx bootloader V3.x versions
28-Nov-2011	13	<p>Added information related to STM32F405/415xx and STM32F407/417xx bootloader, and STM32F105xx/107xx bootloader V2.1.</p> <p>Added value line devices in Section 4: STM32F10xxx devices bootloader title and overview.</p>

Table 110. Document revision history (continued)

Date	Revision	Changes
30-Jul-2012	14	<p>Added information related to STM32F051x6/STM32F051x8 and to High-density ultralow power STM32L151xx, STM32L152xx bootloader.</p> <p>Added case of BOOT1 bit in Section 3.1: Bootloader activation.</p> <p>Updated Connectivity line, High-density ultralow power line, STM32F2xx and STM32F4xx in Table 3: Embedded bootloaders.</p> <p>Added bootloader version V2.2 in Table 8: STM32F105xx/107xx bootloader versions.</p> <p>Added bootloader V2.2 in Section 5.3.1: How to identify STM32F105xx/107xx bootloader versions.</p> <p>Added note related to DFU interface below Table 15: STM32L1xxxx high-density configuration in System memory boot mode. Added V4.2 bootloader know limitations and updated description, and added V4.5 bootloader in Table 16: STM32L1xxxx high-density bootloader versions.</p> <p>Added note related to DFU interface below Table 19: STM32F2xxxx configuration in System memory boot mode. Added V3.2 bootloader know limitations, and added V3.3 bootloader in Table 20: STM32F2xxxx bootloader V3.x versions. Updated STM32F2xx and STM32F4xx system memory end address in Table 21: STM32F40xxx/41xxx configuration in System memory boot mode.</p> <p>Added note related to DFU interface below Table 21: STM32F40xxx/41xxx configuration in System memory boot mode. Added V3.0 bootloader know limitations, and added V3.1 bootloader in Table 22: STM32F40xxx/41xxx bootloader V3.x version.</p> <p>Added bootloader V2.1 know limitations in Table 26: STM32F051xx bootloader versions.</p> <p>Updated STM32F051x6/x8 system memory end address in Table 65: Bootloader device-dependent parameters.</p> <p>Added Table 75: USART bootloader timings for high-density ultralow power devices, and Table 78: USART bootloader timings for STM32F051xx devices.</p> <p>Added Table 88: USB minimum timings for high-density ultralow power devices.</p>

Table 110. Document revision history (continued)

Date	Revision	Changes
24-Jan-2013	15	<p>Updated generic product names throughout the document (see Glossary).</p> <p>Added the following new sections:</p> <ul style="list-style-type: none"> – Section 8: STM32L1xxxC devices bootloader. – Section 13: STM32F031xx devices bootloader. – Section 14: STM32F373xx devices bootloader. – Section 15: STM32F302xB(C)/303xB(C) devices bootloader. – Section 16: STM32F378xx devices bootloader. – Section 17: STM32F358xx devices bootloader. – Section 18: STM32F427xx/437xx devices bootloader. – Section 34.3: I2C bootloader timing characteristics. <p>Updated Section 1: Related documents and Section 2: Glossary.</p> <p>Added Table 79 to Table 85 (USART bootloader timings).</p> <p>Replaced Figure 6 to Figure 16, and Figures 18, 19 and 42.</p> <p>Modified Tables 3, 5, 9, 11, 17, 20, 21, 22 to 13, 27, 29, 31, 33, 35, 37 and 65.</p> <p>Removed "X = 6: one USART is used" in Section 3.3: Hardware connection requirement.</p> <p>Replaced address 0x1FFFF 8002 with address 0x1FFF F802 in Section 12.1: Bootloader configuration.</p> <p>Modified procedure related to execution of the bootloader code in Note: on page 28, in Section 6.2: Bootloader selection and in Section 9.2: Bootloader selection.</p>
06-Feb-2013	16	<p>Added information related to I²C throughout the document.</p> <p>Streamlined Table 1: Applicable products and Section 1: Related documents.</p> <p>Modified Table 3: Embedded bootloaders as follows:</p> <ul style="list-style-type: none"> – Replaced "V6.0" with "V1.0" – Replaced "0x1FFFF7A6" with "0x1FFFF796" in row STM32F31xx – Replaced "0x1FFF7FA6" with "0x1FFFF7A6" in row STM32F051xx <p>Updated figures 6, 9 and 11.</p> <p>Added Note: in Glossary and Note: in Section 3.1: Bootloader activation.</p> <p>Replaced:</p> <ul style="list-style-type: none"> – "1.62 V" with "1.8 V" in tables 17, 19, 19, 22, 21, 27, 37 and 59 – "5 Kbytes" with "4 Kbytes" in row RAM of Table 33 – "127 pages (2 KB each)" with "4 KB (2 pages of 2 KB each)" in rows F3 of Table 65 – "The bootloader ID is programmed in the last two bytes of the device system memory" with "The bootloader ID is programmed in the last byte address - 1 of the device system memory" in Section 3.3: Hardware connection requirement. – "STM32F2xxxx devices revision Y" by "STM32F2xxxx devices revision X and Y" in Section 10: STM32F2xxxx devices bootloader – "Voltage Range 2" with "Voltage Range 1" in tables 11, 15 and 26.

Table 110. Document revision history (continued)

Date	Revision	Changes
21-May-2013	17	<p>Updated:</p> <ul style="list-style-type: none"> – Introduction – Section 2: Glossary – Section 3.3: Hardware connection requirement – Section 7: STM32L1xxx6(8/B) devices bootloader to include STM32L100 value line – Section 32.2: USART connection timing – Section 34.2: USB bootloader timing characteristics – Section 34.3: I2C bootloader timing characteristics – Table 1: Applicable products – Table 3: Embedded bootloaders – Table 25: STM32F051xx configuration in System memory boot mode – Table 27: STM32F031xx configuration in System memory boot mode – Table 65: Bootloader device-dependent parameters – Figure 17: Bootloader selection for STM32F031xx devices <p>Added Section 19: STM32F429xx/439xx devices bootloader.</p>
19-May-2014	18	<p>Add:</p> <ul style="list-style-type: none"> – Figure 1 to Figure 5, Figure 57, Figure 6, Figure 25, Figure 26, Figure 24, from Figure 37 to Figure 63, Figure 67 – Table 4, Table 96, Table 97, from Table 6 to Table 45, from Table 46 to Table 43, from Table 66 to Table 67, from Table to Table 109 – Section 38.4, Section 31.2, Section 48.1, Section 48.5 – Section 4, Section 22, Section 23, Section 21, from Section 16 to Section 46 – note under Figure 1, Figure 2, Figure 3 and Figure 4 <p>Updated:</p> <ul style="list-style-type: none"> – Updated starting from Section 3 to Section 6 and Section 17, Section 31 and Section 31 the chapter structure organized in three subsection: Bootloader configuration, Bootloader selection and Bootloader version. Updated Section 46 and Section 48 – Updated block diagram of Figure 25 and Figure 20. – Fixed I2C address for STM32F429xx/439xx devices in Table 64 – Table 1, Table 2, Table 3, Table 24, Table 90, Table 92, Table 94, Table 28, Table 30, Table 50, Table 104 – from Figure 14, to Figure 28, Figure 8, from Figure 63 to Figure 67 – note on Table 91

Table 110. Document revision history (continued)

Date	Revision	Changes
29-Jul-2014	19	<p>Updated:</p> <ul style="list-style-type: none"> – notes under Table 2 – Figure 56 and Figure 57 – Section 2: Glossary – replaced any reference to STM32F427xx/437xx with STM32F42xxx/43xxx on Section 31: STM32F42xxx/43xxx devices bootloader – replace any occurrence of ‘STM32F072xx’ with ‘STM32F07xxx’ – replace any occurrence of ‘STM32F051xx’ with ‘STM32F051xx and STM32F030x8 devices’. – comment field related to OTG_FS_DP and OTG_FS_DM on Table 24, Table 30, Table 50, Table 96, Table 64, Table 66, Table 12, Table 18, Table 54, Table 56 and Table 60 – comment field related to USB_DM on Table 96. – replace reference to "STM32F429xx/439xx" by "STM32F42xxx/43xxx" on Table 3 – comment field related to SPI2_MOSI, SPI2_MISO, SPI2_SCK and SPI2_NSS pins on Table 66 <p>Added:</p> <ul style="list-style-type: none"> – note under Table 2 – reference to STM32F411 on Table 1, Section 2: Glossary, Table 105, Table 106, Table 107, Table 108 – Section 29: STM32F411xx devices bootloader <p>Removed reference to STM32F427xx/437xx on Table 3, Section 2: Glossary, Table 104, Table 105, Table 106, Table 107</p>
24-Nov-2014	20	<p>Updated:</p> <ul style="list-style-type: none"> – comment in "SPI1_NSS pin" and "SPI2_NSS pin" rows on Table 96 and Table 82 – comment in "SPI1_NSS pin", "SPI2_NSS pin" and "SPI3_NSS pin" rows on Table 54, Table 56 and Table 60 – Figure 1
11-Mar-2015	21	<p>Updated:</p> <ul style="list-style-type: none"> – Table 1, Table 3, Table 22, Table 26, Table 90, Table 28, Table 30, Table 31, Table 50, Table 96, Table 10, Table 11, Table 6, Table 34, Table 64, Table 66, Table 12, Table 13, Table 18, Table 19, Table 32, Table 88, Table 100, Table 104, Table 105, Table 106, Table 107 and Table 108 – Figure 60 – Chapter 2: Glossary – Section 3.1 and Section 3.4 <p>Added:</p> <ul style="list-style-type: none"> – Section 46: STM32L476xx/486xx devices bootloader and Section 32: STM32F446xx devices bootloader

Table 110. Document revision history (continued)

Date	Revision	Changes
09-Jun-2015	22	Added: – Section 8: STM32F070x6 devices bootloader – Section 9: STM32F070xB devices bootloader – Section 11: STM32F09xxx devices bootloader – Section 18: STM32F302xD(E)/303xD(E) devices bootloader – Section 24: STM32F398xx devices bootloader – Section 34: STM32F74xxx/75xxx devices bootloader – Section 46.2: Bootloader V9.x – Notes 1 and 2 on Figure 64 Updated: – Table 1 – Section 2: Glossary – Table 2 – Table 3 – Section 3.4: Bootloader Memory Management – Table 104 , Table 105 , Table 106 , Table 107 and Table 108
29-Sep-2015	23	Added: – Section 28: STM32F410xx device bootloader – Section 33: STM32F469xx/479xx devices bootloader – Section 37: STM32L031xx/041xx devices bootloader – Section 39: STM32L07xxx/08xxx devices bootloader Updated: – Table 1 – Section 2: Glossary – Table 3 – Figure 60 , Table 102 , Table 105 , Table 106 , Table 107 , Table 108
02-Nov-2015	24	Updated: – Table 1 , Table 3 , Table 104 , Table 105 , Table 106 , Table 107 , Table 108 – Section 33 Added: – Note on Section 25.2.1 – Section 30
01-Dec-2015	25	Updated: – Section 3.1 , Section 39 – Table 104
03-Mar-2016	26	Updated: – Table 1 , Table 3 , Table 63 , Table 85 , Table 87 , Table 104 – Section 2 , Section 39.1.1 , Section 39.2.1 , Section 46 Added: – Section 36: STM32L01xxx/02xxx devices bootloader – Figure 49 , Figure 51

Table 110. Document revision history (continued)

Date	Revision	Changes
21-Apr-2016	27	<p>Added:</p> <ul style="list-style-type: none"> – Section 35: STM32F76xx/77xx devices bootloader, Section 45: STM32L43xx/44xx devices bootloader. – Note on: Section 3.1: Bootloader activation, Section 7.1: Bootloader configuration, Section 8.1: Bootloader configuration, Figure 35: Dual Bank Boot Implementation for STM32F42xx/43xx Bootloader V7.x, Figure 37: Dual Bank Boot Implementation for STM32F42xx/43xx Bootloader V9.x <p>Updated:</p> <ul style="list-style-type: none"> – Table 1: Applicable products, Table 2: Bootloader activation patterns, Table 8: STM32F030xC configuration in system memory boot mode, Table 14: STM32F070x6 configuration in system memory boot mode, Table 16: STM32F070xB configuration in system memory boot mode, Table 20: STM32F09xxx configuration in system memory boot mode, Table 32: STM32F301xx/302x4(6/8) configuration in system memory boot mode, Table 34: STM32F302xB(C)/303xB(C) configuration in system memory boot mode, Table 36: STM32F302xD(E)/303xD(E) configuration in system memory boot mode, Table 44: STM32F373xx configuration in system memory boot mode, Table 54: STM32F401xB(C) configuration in system memory boot mode, Table 56: STM32F401xD(E) configuration in system memory boot mode, Table 60: STM32F411xx configuration in system memory boot mode, Table 101: STM32L476xx/486xx bootloader V10.x versions, Table 103: STM32L476xx/486xx bootloader V9.x versions, Table 104: Bootloader device-dependent parameters – Section 2: Glossary,

Table 110. Document revision history (continued)

Date	Revision	Changes
05-Sep-2016	28	<p>Updated:</p> <ul style="list-style-type: none"> - <i>Table 1: Applicable products, Table 8: STM32F030xC configuration in system memory boot mode, Table 10: STM32F05xxx and STM32F030x8 devices configuration in system memory boot mode, Table 12: STM32F04xxx configuration in system memory boot mode, Table 14: STM32F070x6 configuration in system memory boot mode, Table 16: STM32F070xB configuration in system memory boot mode, Table 18: STM32F071xx/72xx configuration in system memory boot mode, Table 20: STM32F09xxx configuration in system memory boot mode, Table 24: STM32F105xx/107xx configuration in system memory boot mode, Table 26: STM32F10xxx XL-density configuration in system memory boot mode, Table 28: STM32F2xxxx configuration in system memory boot mode, Table 30: STM32F2xxxx configuration in system memory boot mode, Table 32: STM32F301xx/302x4(6/8) configuration in system memory boot mode, Table 34: STM32F302xB(C)/303xB(C) configuration in system memory boot mode, Table 36: STM32F302xD(E)/303xD(E) configuration in system memory boot mode, Table 38: STM32F303x4(6/8)/334xx/328xx configuration in system memory boot mode, Table 40: STM32F318xx configuration in system memory boot mode, Table 42: STM32F358xx configuration in system memory boot mode, Table 44: STM32F373xx configuration in system memory boot mode, Table 46: STM32F378xx configuration in system memory boot mode, Table 48: STM32F398xx configuration in system memory boot mode, Table 50: STM32F40xxx/41xxx configuration in system memory boot mode, Table 52: STM32F40xxx/41xxx configuration in system memory boot mode, Table 54: STM32F401xB(C) configuration in system memory boot mode, Table 56: STM32F401xD(E) configuration in system memory boot mode, Table 60: STM32F411xx configuration in system memory boot mode, Table 64: STM32F42xxx/43xxx configuration in system memory boot mode, Table 66: STM32F42xxx/43xxx configuration in system memory boot mode, Table 68: STM32F446xx configuration in system memory boot mode, Table 70: STM32F469xx/479xx configuration in system memory boot mode, Table 72: STM32F74xxx/75xxx configuration in system memory boot mode, Table 74: STM32F74xxx/75xxx configuration in system memory boot mode, Table 82: STM32L05xxx/06xxx configuration in system memory boot mode, Table 88: STM32L1xxx6(8/B)A configuration in system memory boot mode, Table 90: STM32L1xxx6(8/B) configuration in system memory boot mode, Table 92: STM32L1xxxC configuration in system memory boot mode, Table 94: STM32L1xxxD configuration in system memory boot mode, Table 96: STM32L1xxxE configuration in system memory boot mode, Table 99: STM32L43xx/44xx bootloader versions, Table 100: STM32L476xx/486xx configuration in system memory boot mode, Table 104: Bootloader device-dependent parameters</i> - <i>Section 45.1: Bootloader configuration</i>

Table 110. Document revision history (continued)

Date	Revision	Changes
05-Sep-2016	28 (continued)	– <i>Figure 22: Bootloader selection for STM32F303x4(6/8)/334xx/328xx, Figure 23: Bootloader selection for STM32F318xx, Figure 25: Bootloader selection for STM32F373xx devices, Figure 26: Bootloader selection for STM32F378xx devices, Figure 29: Bootloader V9.x selection for STM32F40xx/41xxx, Figure 32: Bootloader V11.x selection for STM32F410xx, Figure 34: Bootloader V9.x selection for STM32F412xx, Figure 41: Bootloader V9.x selection for STM32F469xx/479xx, Figure 45: Bootloader V9.x selection for STM32F76xxx/77xxx, Figure 52: Bootloader V11.x selection for STM32L07xxx/08xxx, Figure 60: Bootloader V10.x selection for STM32L476xx/486xx</i>

IMPORTANT NOTICE – PLEASE READ CAREFULLY

STMicroelectronics NV and its subsidiaries ("ST") reserve the right to make changes, corrections, enhancements, modifications, and improvements to ST products and/or to this document at any time without notice. Purchasers should obtain the latest relevant information on ST products before placing orders. ST products are sold pursuant to ST's terms and conditions of sale in place at the time of order acknowledgement.

Purchasers are solely responsible for the choice, selection, and use of ST products and ST assumes no liability for application assistance or the design of Purchasers' products.

No license, express or implied, to any intellectual property right is granted by ST herein.

Resale of ST products with provisions different from the information set forth herein shall void any warranty granted by ST for such product.

ST and the ST logo are trademarks of ST. All other product or service names are the property of their respective owners.

Information in this document supersedes and replaces information previously supplied in any prior versions of this document.

© 2016 STMicroelectronics – All rights reserved